



IRENA

International Renewable Energy Agency

Factors influencing the long-term planning for VREs: Challenges and opportunities

7 November 2018, Vienna



Key take away from this presentation

- » Rising shares of renewable power constitute a global and a European trend
- » Establishing a long-term vision for power sector transformation can avoid costly misinvestments and facilitate VRE integration
- » To plan for a system with higher share of renewable energy, coordination among different planning processes across different institutions is crucial
- » IRENA offers supports in planning methodologies and their implementations

IRENA's Global Coverage

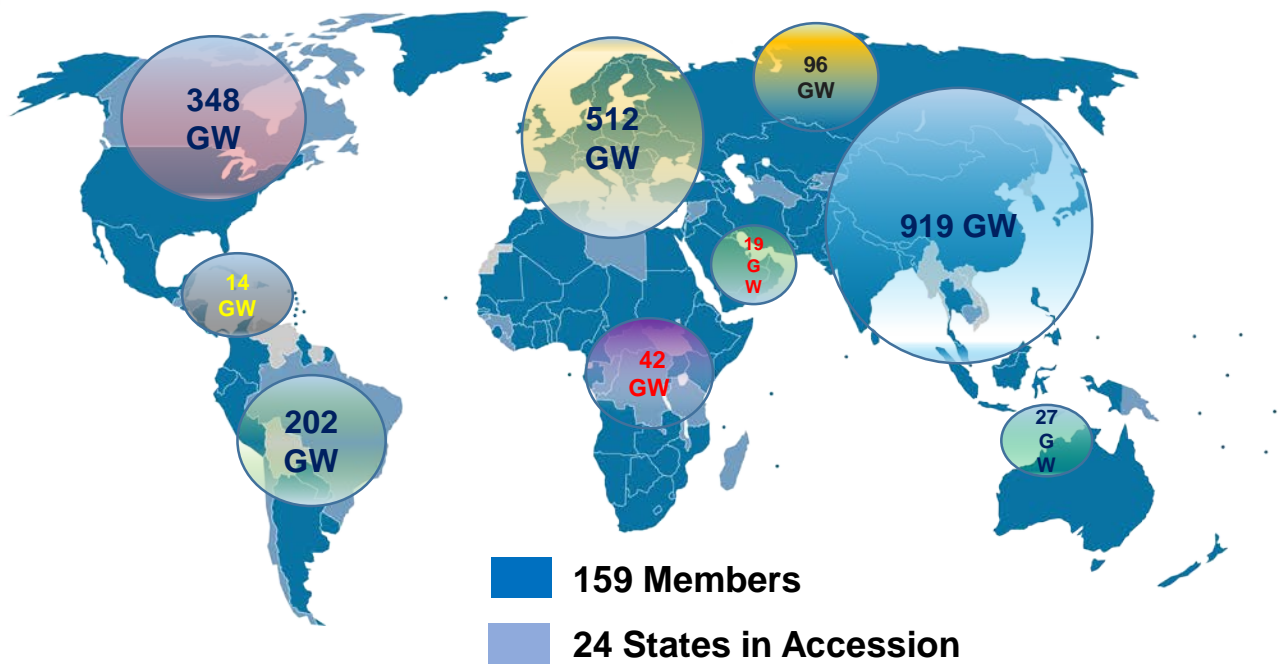

Representing:

- ☐ 98.6% of the global installed renewable electricity generation capacity (2017)
- ☐ 94% of the global renewable electricity generation output (2016)

Global power capacity additions

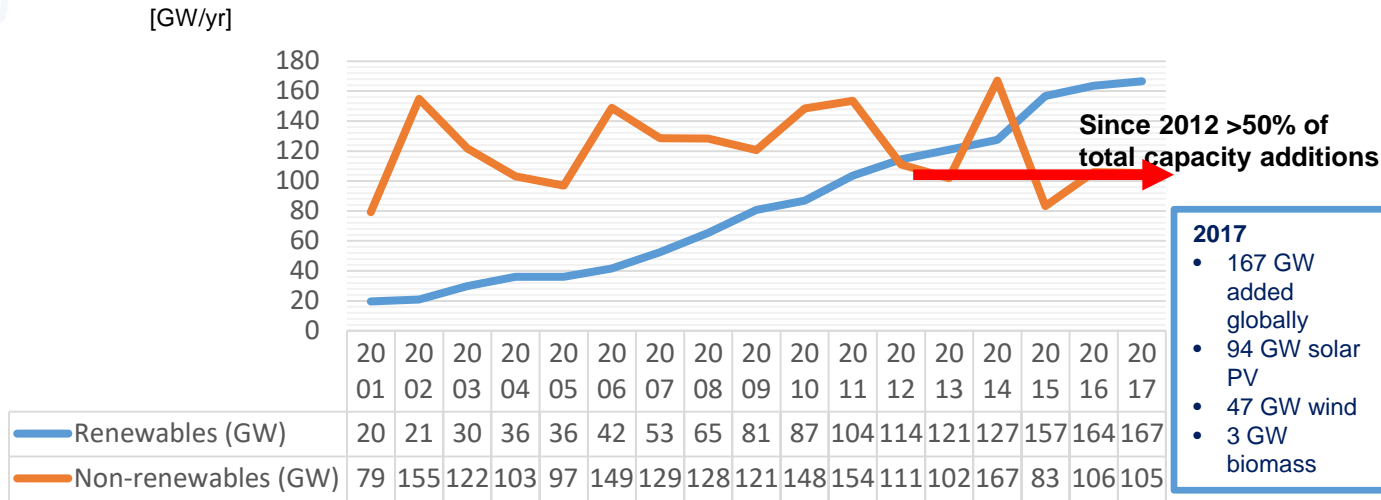

Source: IRENA statistics

In **2017** around **26% renewable power generation share worldwide**, >2000 GW capacity

- Wind and solar PV led the uptake of RES
- **Solar PV** accounted for more than **56% of total RES additional installed capacity in 2017**

VRE growth has surpassed expert projections

WEO: IEA World Energy Outlook

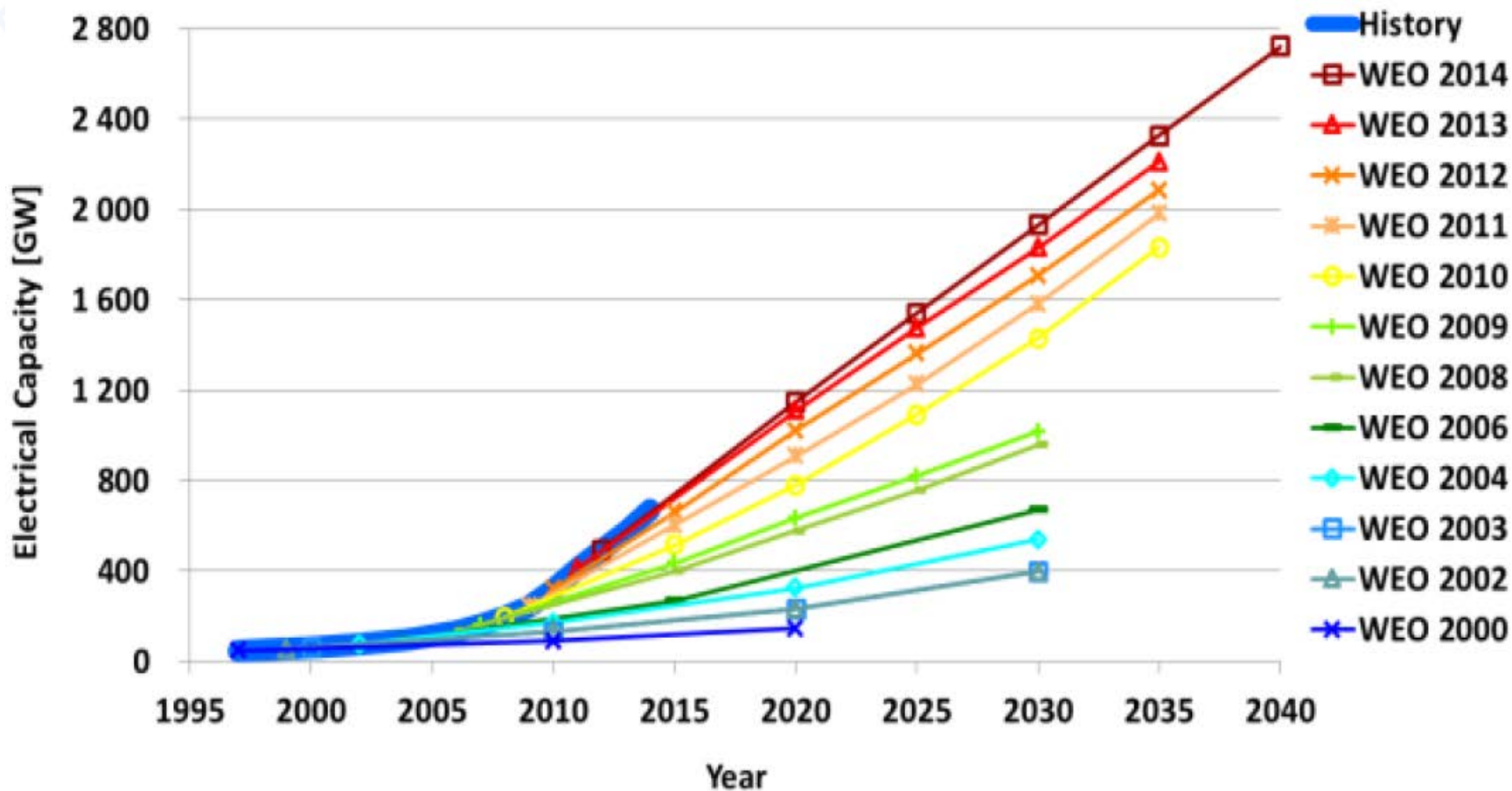

Source: Metayer et. al (2016), The projections for the future and quality in the past of the World Energy Outlook for solar PV and other renewable energy technologies; and Gilbert et. al (2016), Looking the wrong way: Bias, renewable electricity, and energy modelling in the United States

Electrification of end-use sectors: Key enabler for the energy transformation

Gross power generation will almost double between 2015 and 2050, due to electrification of end-use sectors, with renewables generating **85%**

VRE – solar PV and wind - will be at the core of the Power Sector Transformation – 60% VRE by 2050 global average

Breakdown of electricity generation by source

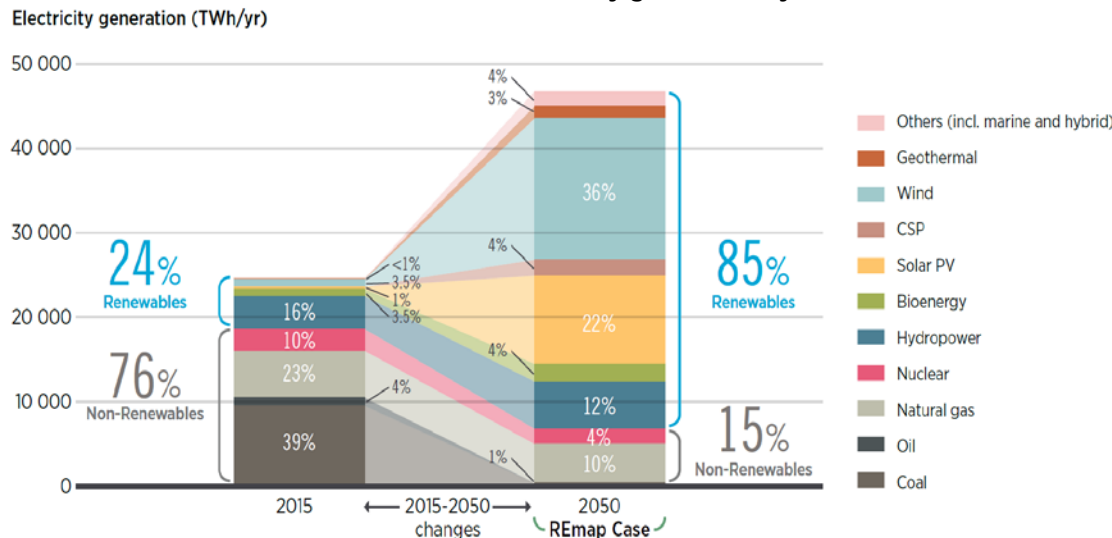

Source: IRENA (2018) Global Energy Transformation: A Roadmap to 2050

REmap Case

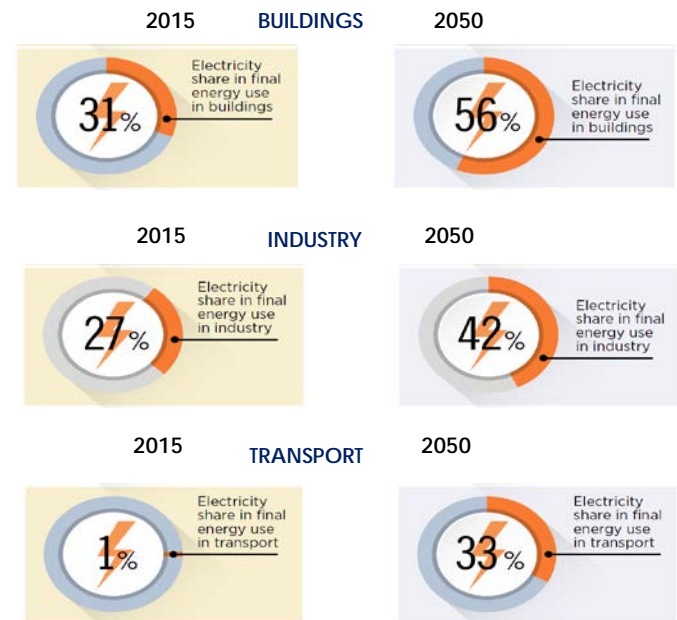

Investments will need to shift to renewable energy and energy efficiency

Reference Case energy sector investments between 2015-50 (USD trillion)

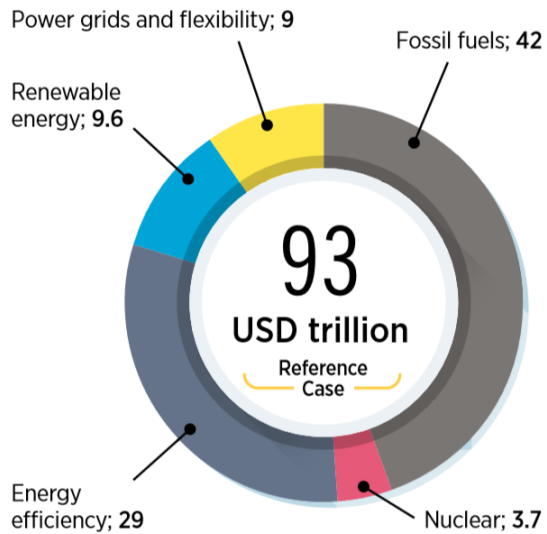

REmap Case energy sector investments between 2015-50 (USD trillion)

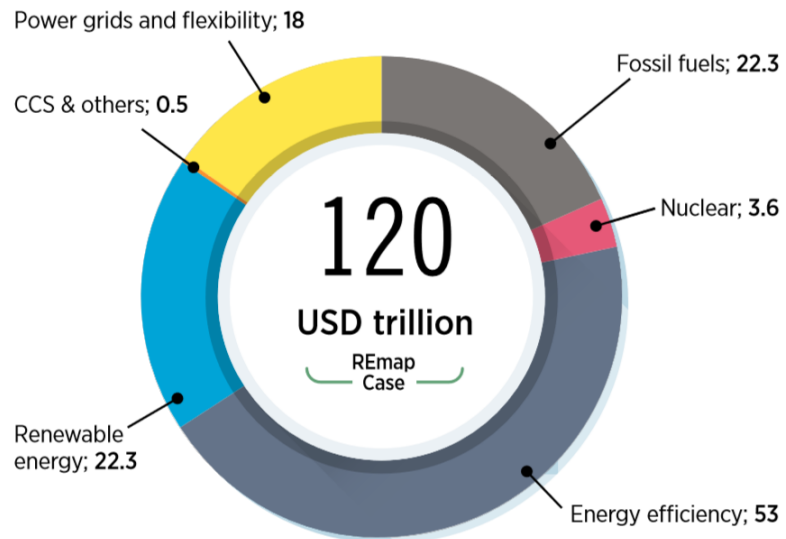

Renewable power rapidly becoming competitive

Cost reduction in the period
2010 - 2017



73
%

Solar PV



23
%

Onshore
Wind



Expected cost reduction in the period
2015 - 2025



54% **37%**
Solar PV CSP



15% **12%**
Offshore Wind Onshore Wind



- All renewable power options will compete with fossil fuels on price by 2020
- Wind and PV are abundant and available in most countries

Rapidly falling cost for new technologies that broaden the resource base

Global Levelised Cost of Electricity

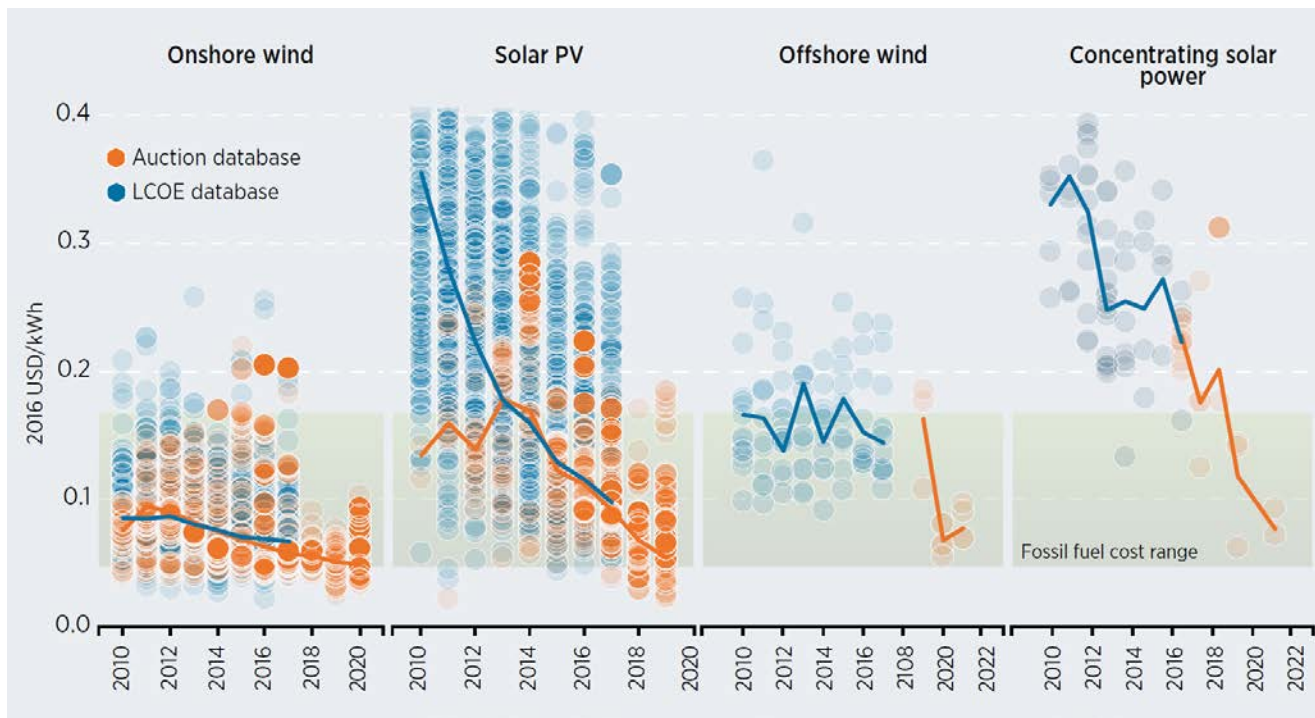

Source: IRENA Renewables cost database

Innovation unlocking flexibility across whole power system

Conventional providers of flexibility

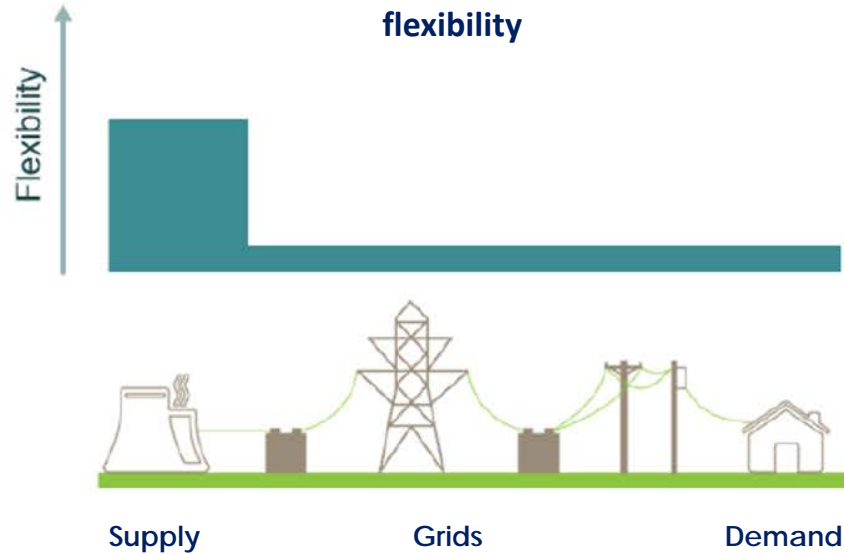

Emerging providers of flexibility

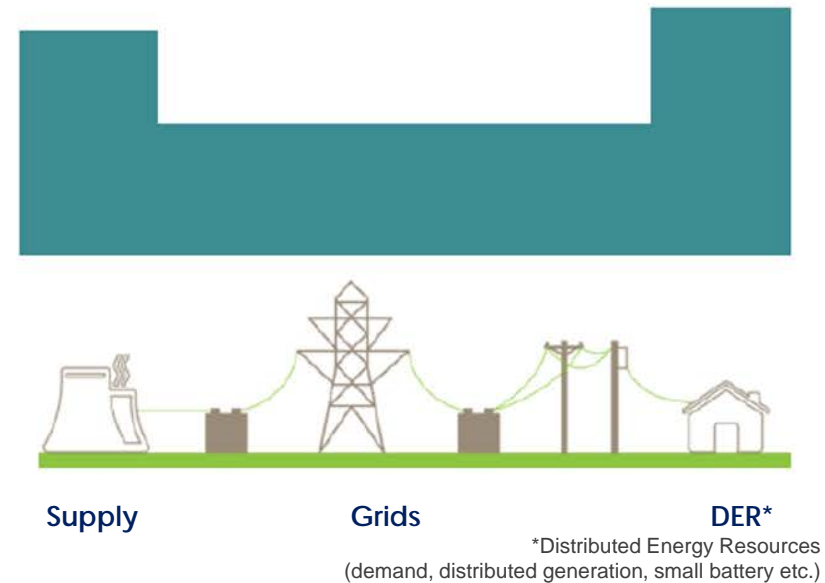

Flexibility sources:

- Flexible generation

Flexibility sources:

- Flexible generation
- Regional interconnections and markets
- Demand response
- Storage
- Power to X

Numerous innovations are emerging to facilitate wind and PV integration

Innovations come from different dimensions: Enabling technology, Business models, Market design and Systems operation

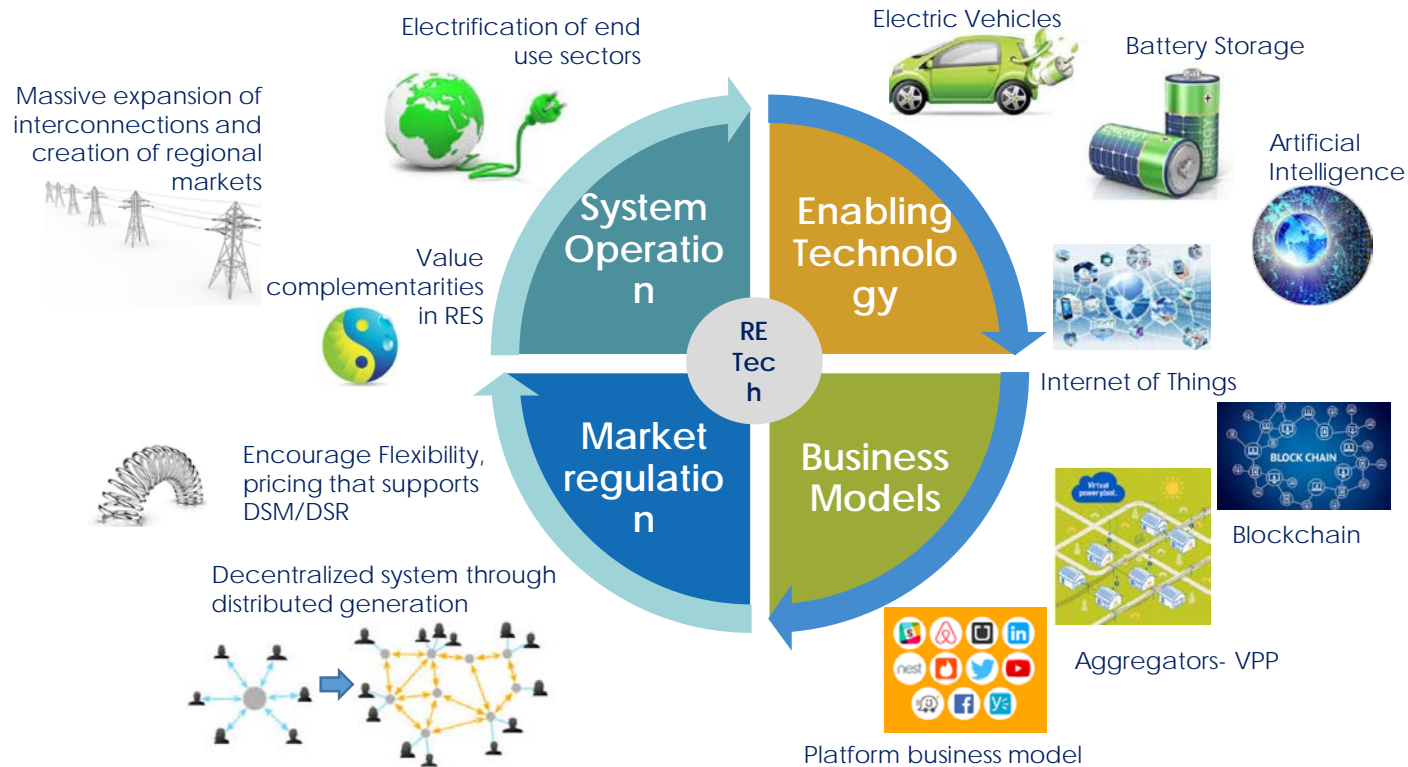

Innovative solutions to increase power systems flexibility propelled by three trends

- **Decentralisation** - Wind and PV are largely centralised today but distributed generation - notably rooftop PV (~ 1% of all electricity generation today) is growing, bringing new flexibility opportunities on the demand side
- **Digitalisation** - Key enabler to amplify the energy transformation by managing large amounts of data and optimizing systems with many small generation units
- **Electrification** - It plays in two ways, may decarbonise end-use sectors through renewable electricity and, if done in a smart way, become a flexibility source to integrate more renewables in power systems

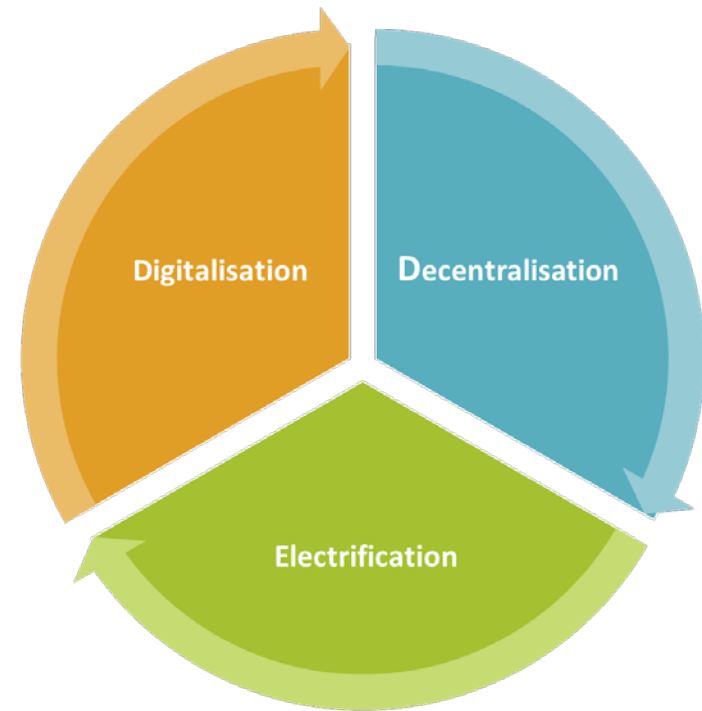

Eurelectric: EU electrification projections

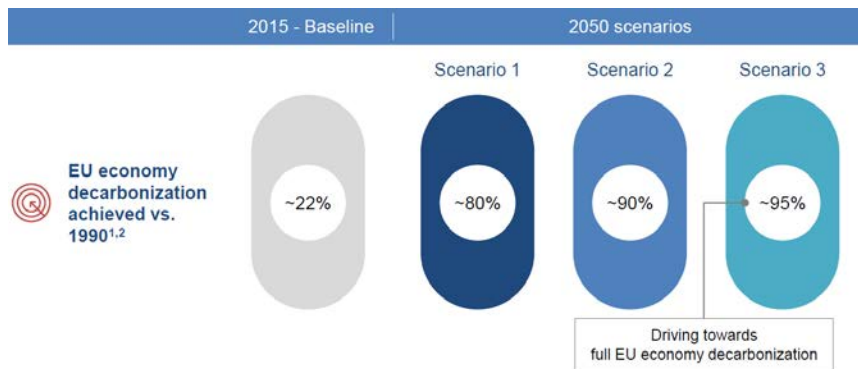
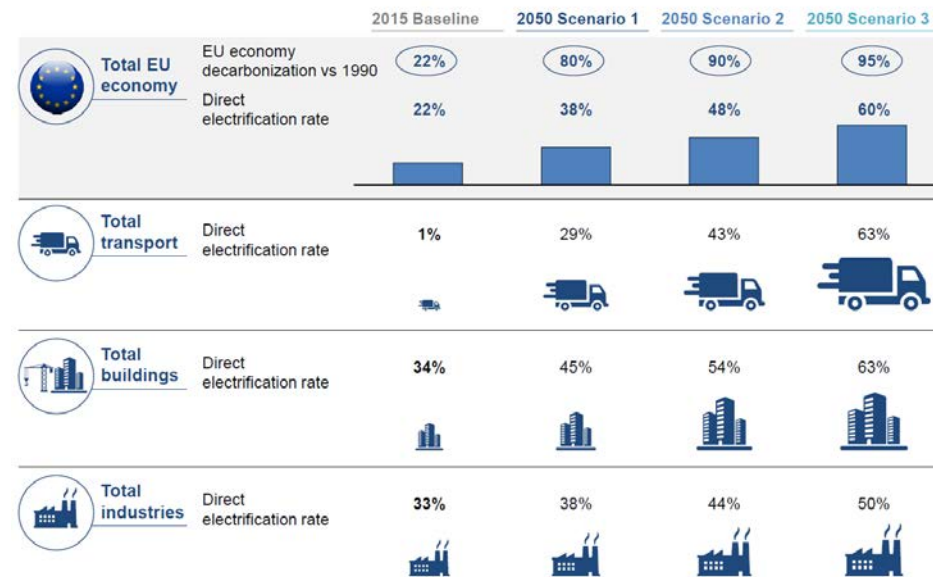

Table. Electrification fraction by scenario in Europe in 2050

Europe	scenario 1 80% decarbonization	scenario 2 90% decarbonization	scenario 3 95% decarbonization	2015 baseline
transport	29%	43%	63%	1%
building	45%	54%	63%	34%
industry	38%	44%	50%	33%
total	38%	48%	60%	22%

Note: 1. the results is for the European region;
2. there is no data for renewable energy or its fraction.

Direct electrification results by scenario



REmap analysis for the European Union

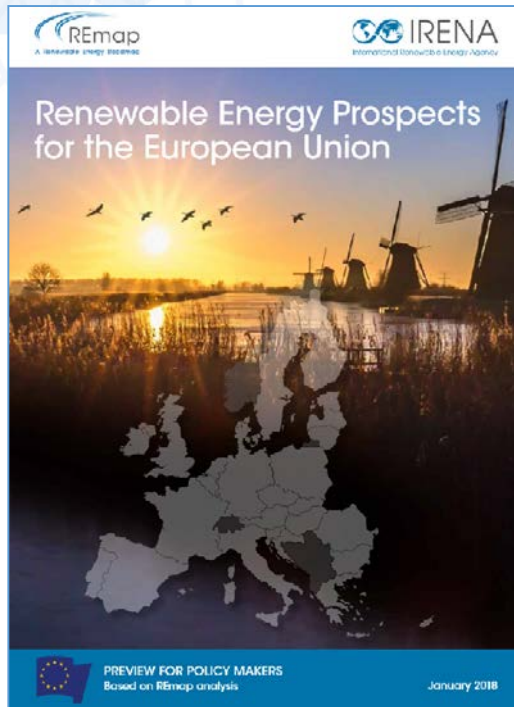

- » **Background:**
 - » In 2014, the European Council agreed on 2030 climate and energy targets, including a minimum of 27% renewables
 - » Discussions on the “Clean Energy for All Europeans” legislative package.

- » **Aim:**
 - » Identify options to meet and potentially exceed the proposed 27% renewables target for 2030
 - » Assess the aggregated impact of national renewable energy plans
 - » Assess the role of renewables in long-term decarbonisation

EU power sector – generation

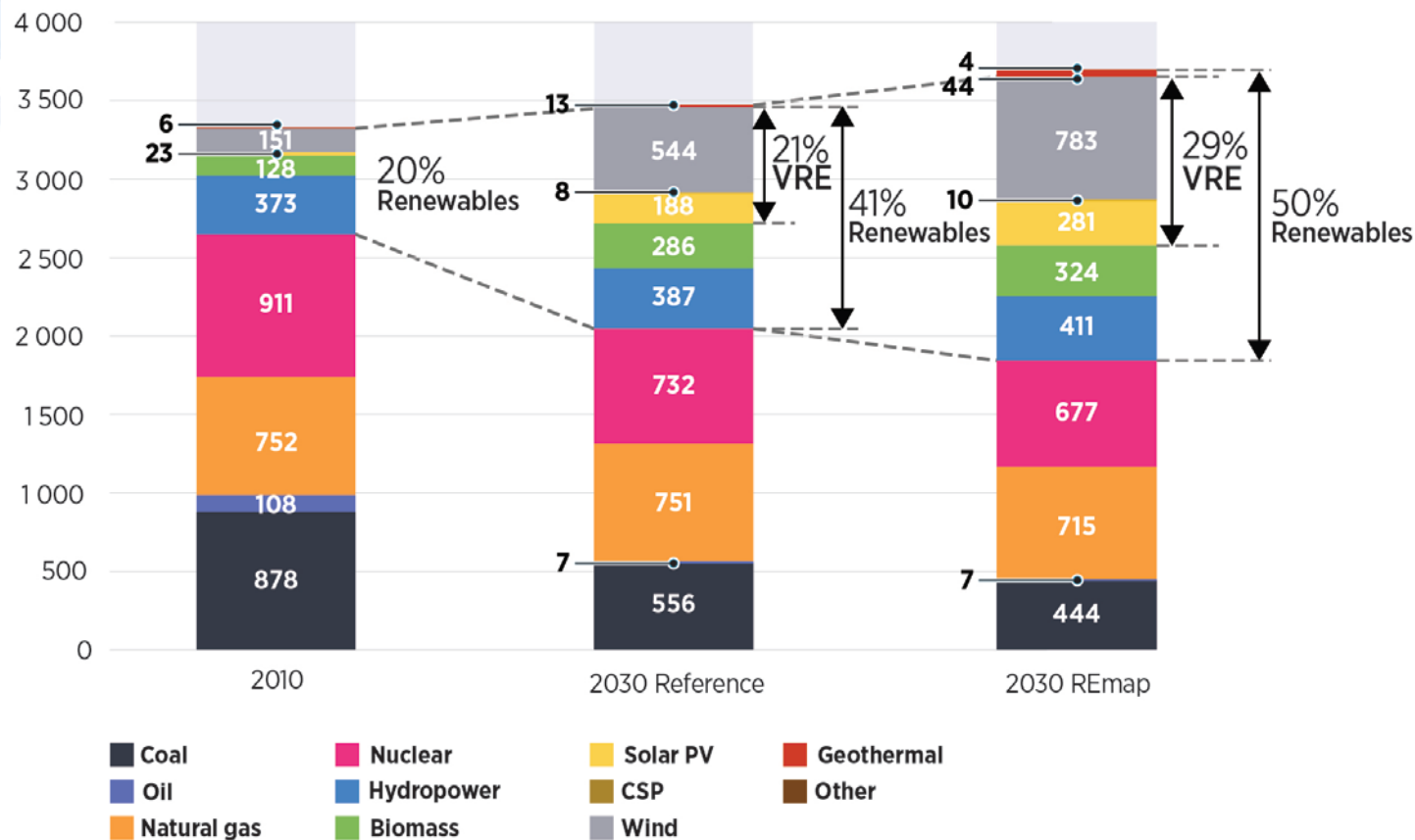

Note: PV = photovoltaic; CSP = concentrated solar power; VRE = variable renewable energy

Health impacts

- » Today: 400,000 premature deaths in the EU due to air pollution*.
- » REmap **avoided health damages alone** are estimated at **19 to 71 billion USD/year by 2030**
- » Avoided impacts almost **evenly distributed among transport, buildings and power**, with more or less 30% each, and the remainder of around 6% for industry.

Key challenges in the coming years

- » Operating power systems with >50% VRE
 - » Flexibility options (smart grids, flexible fossil, VRE mix, interconnectors, pumped hydro, batteries, DSM/DSR)
- » Electrification & sector coupling
 - » Electric vehicles smart charging (and V2G ?)
 - » Heat pumps with thermal storage
 - » Electrification of industrial processes
 - » Hydrogen and Power to X

Why long-term energy planning?

- » Central component: Scenario building
- » Process for building consensus based on data and evidence, and transparent assumptions
- » Sharing the vision domestically and internationally
- » Creating signals for investors and incentivize new business opportunities

- » Identify the near-term work to do
 - » Policy design
 - » Regulatory design
 - » Technical preparation



How much electricity demand will there be?



How much and what type of generation is needed to serve this demand?



What enhancements to the network are needed to ensure the reliable supply of electricity?

Energy/power system models are used to answer these questions while taking into account economic and technical consequences of alternative choices.

Time dimensions of power sector planning

Typical time resolution

Typical time frame

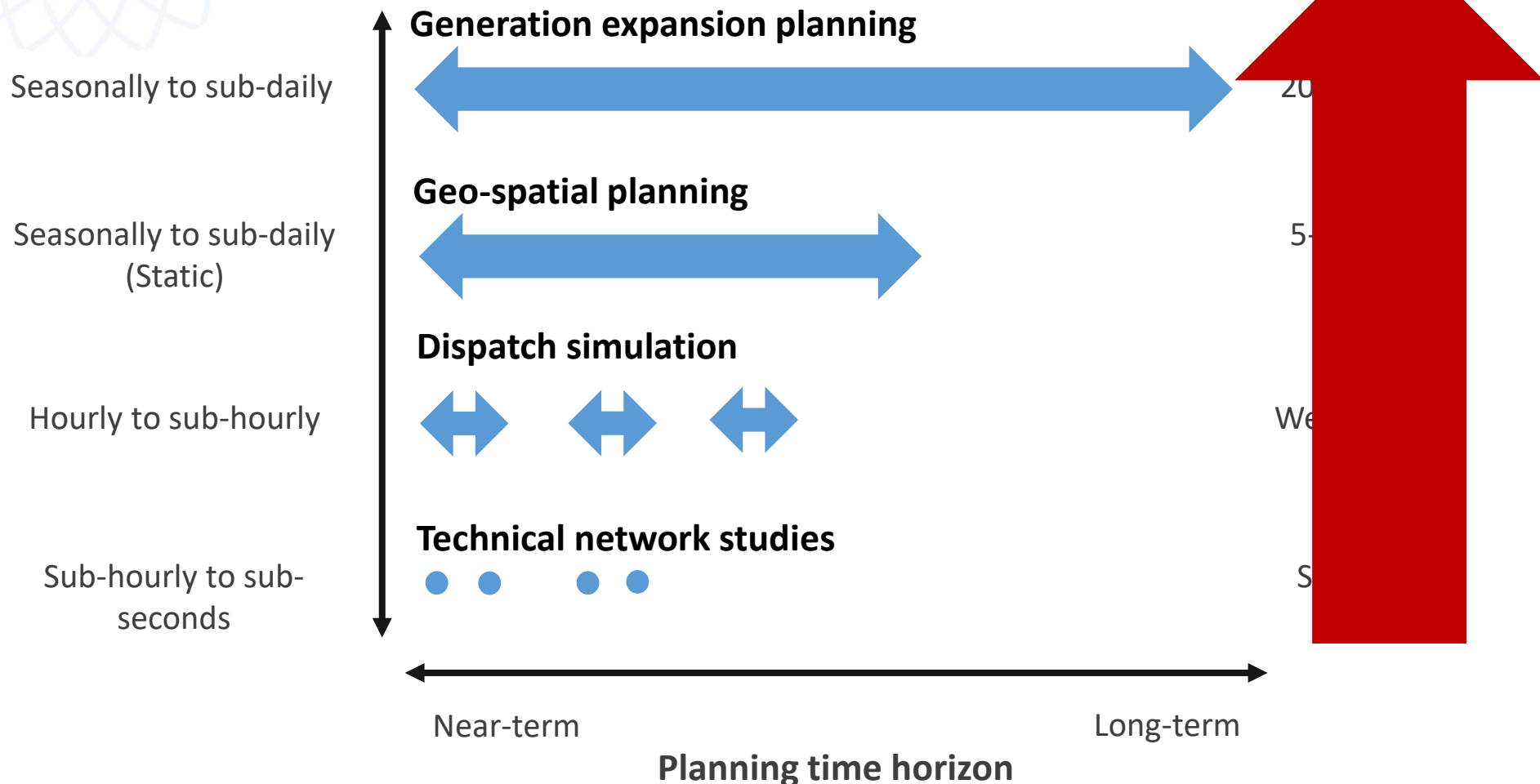

Modelling software – indicative coverage

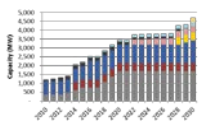
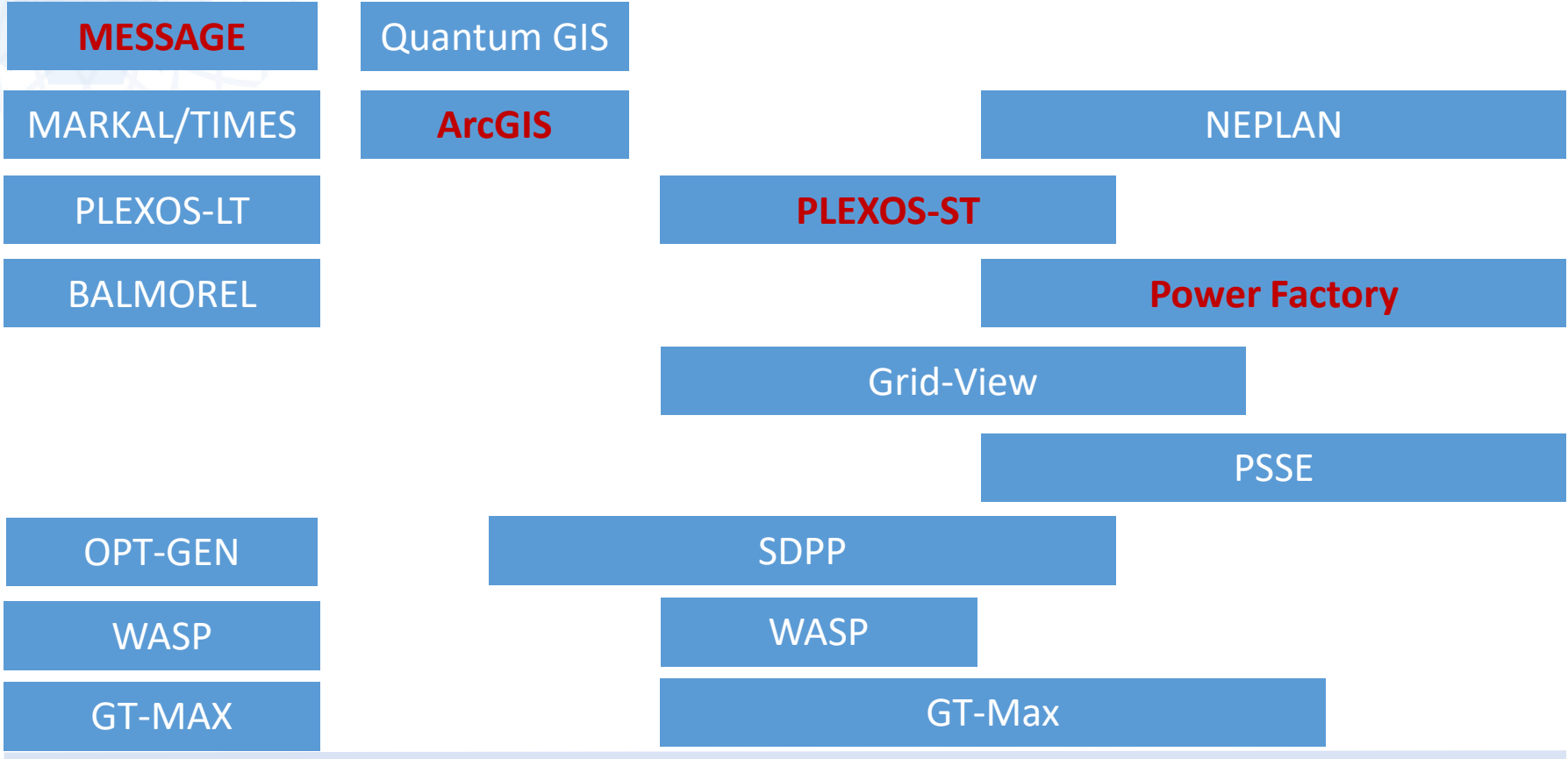

Cap expansion

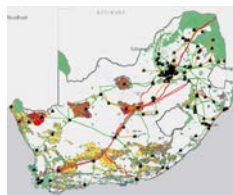

Geo-spatial

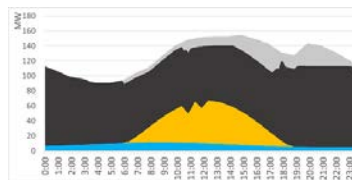

Dispatch

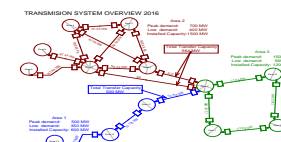

Static

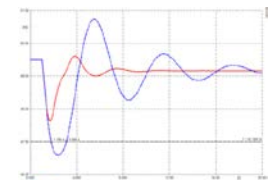

Dynamic

Typical data requirements

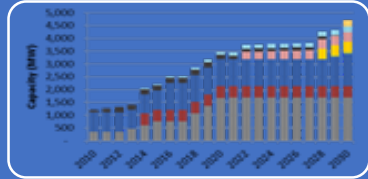

Demand, demand profile
Technology costs, technology operational characteristics, fuel prices, resource availability

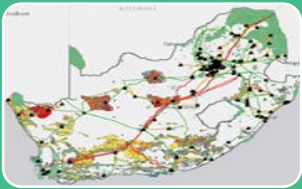

Meteorological information
Site specific demand profile

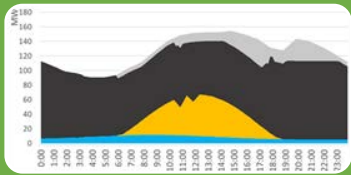

Capacity mix, network topology
Detailed load profile and technology characteristics



Detailed network topology, and technical characteristics
Demand at each node
Operational procedure and technical regulation

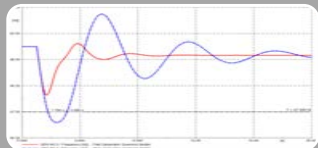

Protection system settings
Units providing primary/governor control

Planning tools

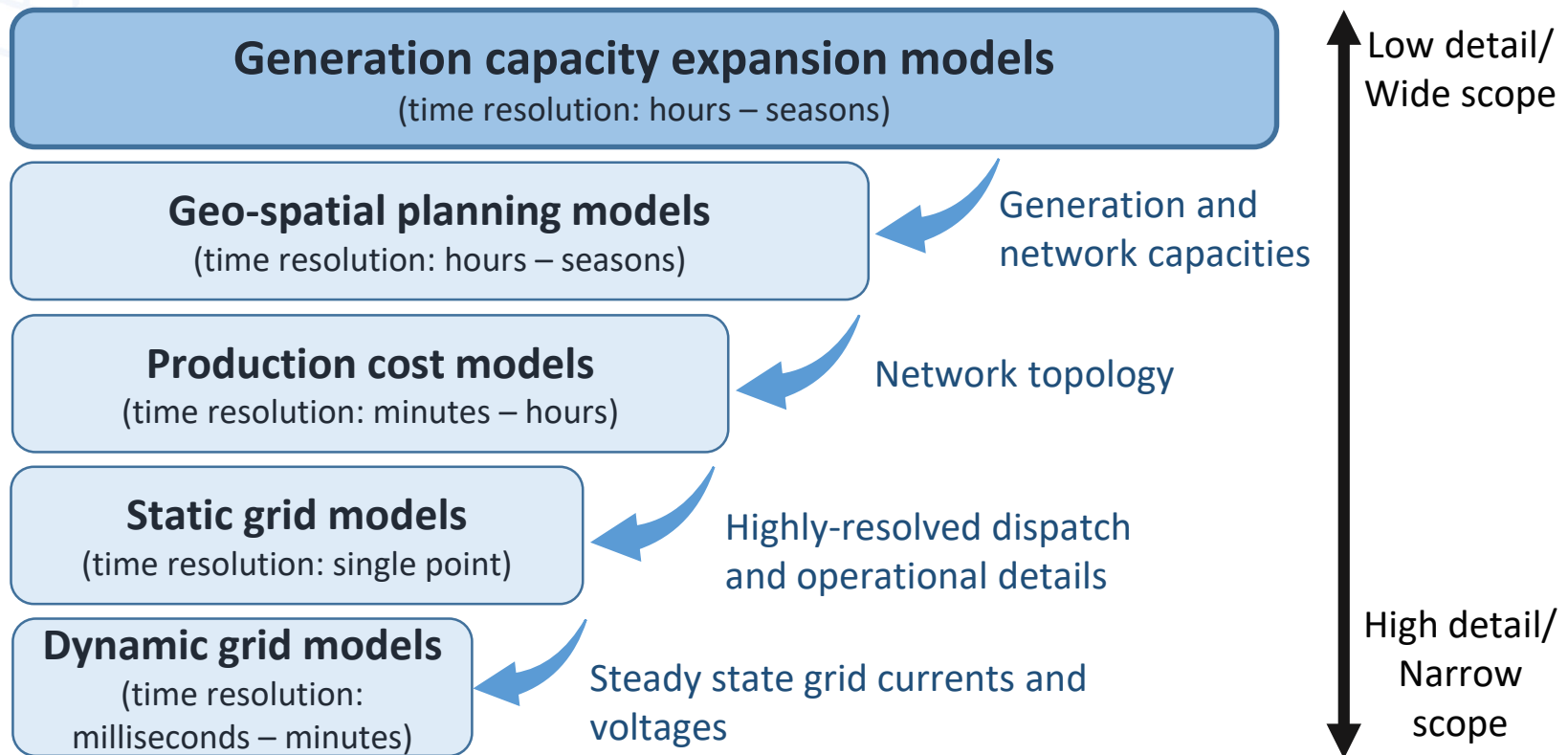

Variable Renewable Energy (VRE) in the planning process

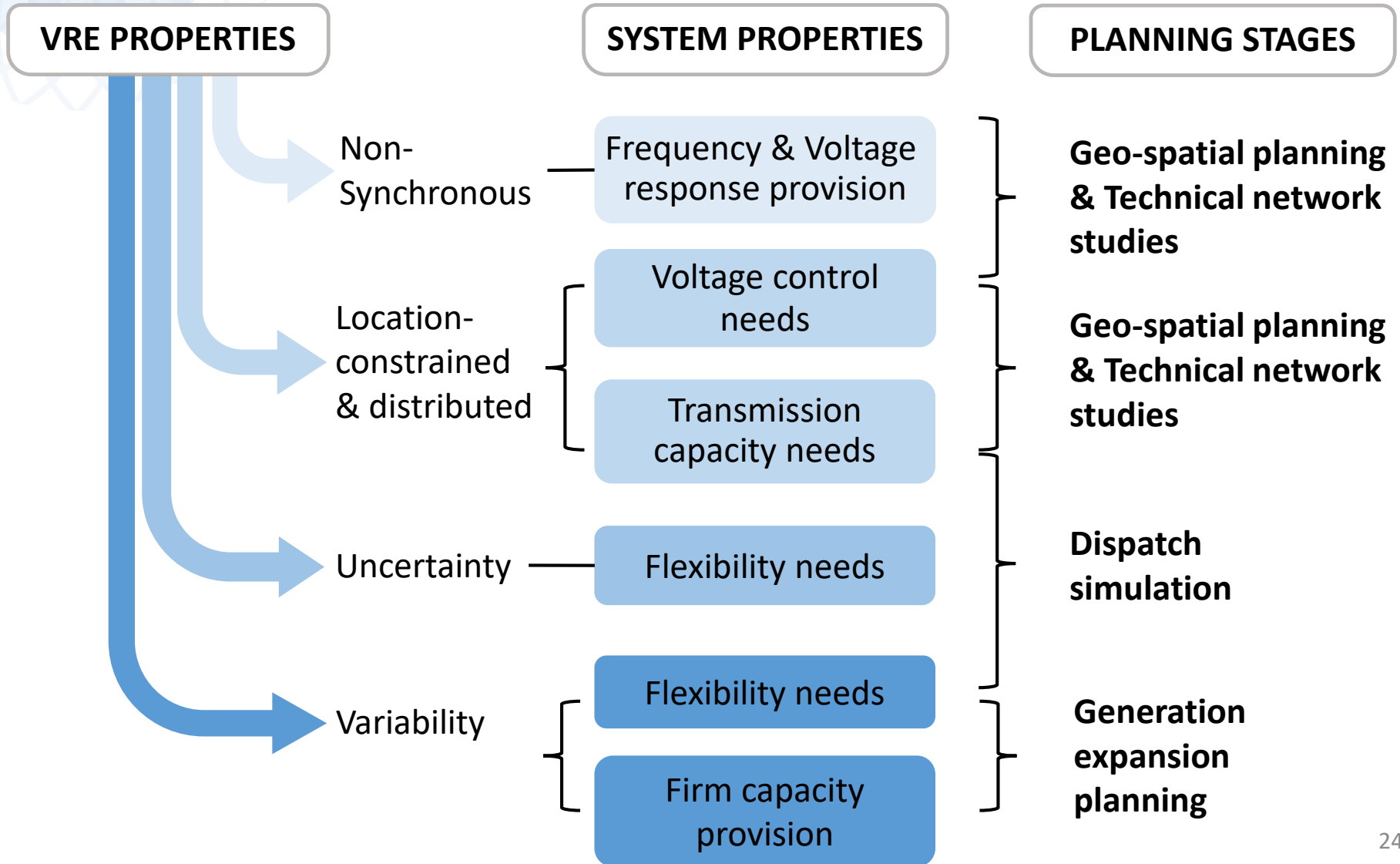

Long-term energy planning with VRE

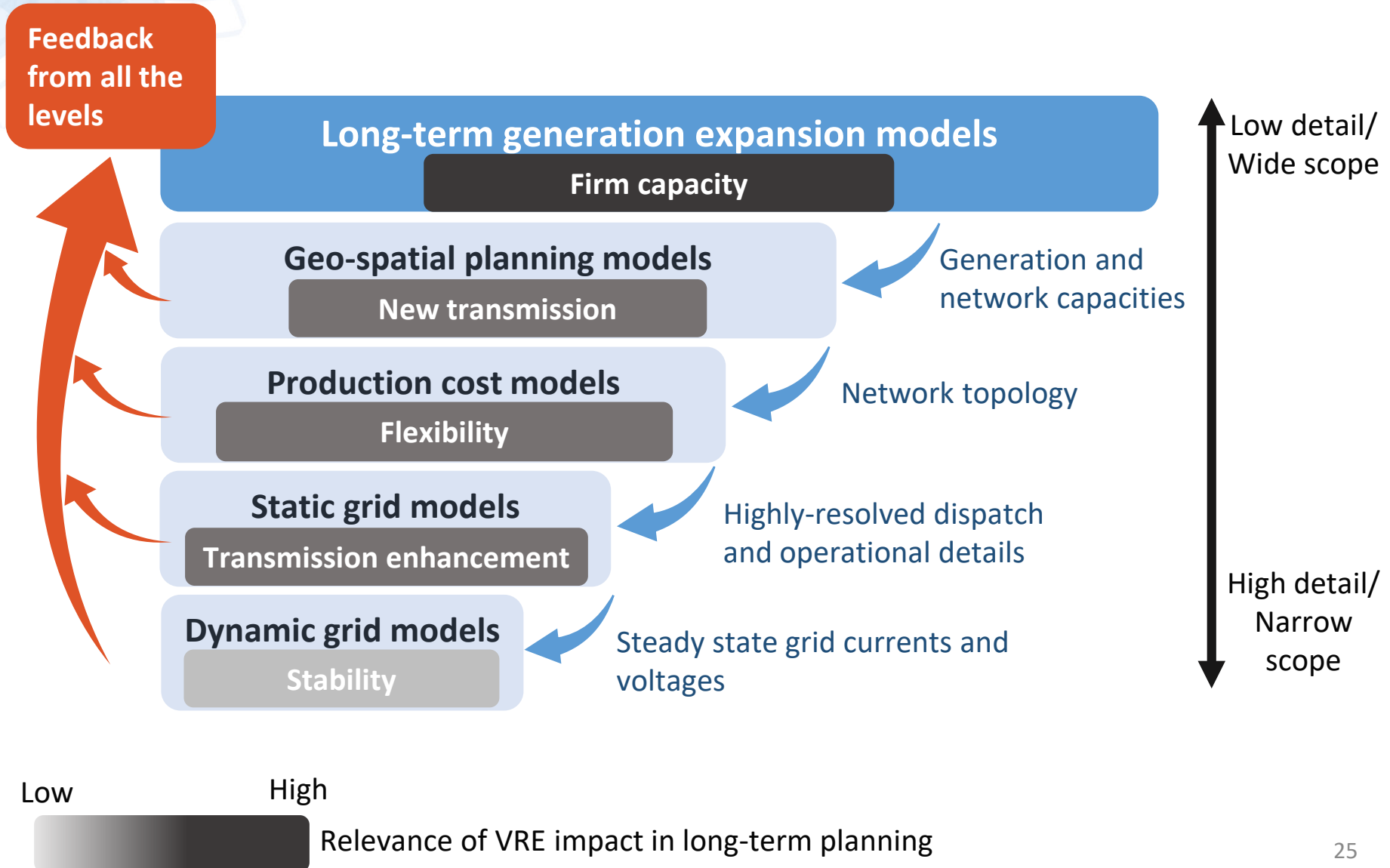

Conclusion

It is important to do it right from the beginning!

How?

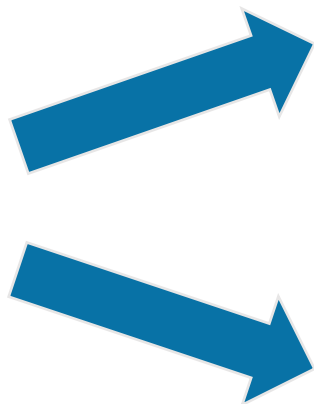

Improve long-term energy planning modeling methodologies by incorporating key VRE features

Coordinated planning across planning bodies

IRENA's country support programme offers country specific planning support



Two methodological guides from IRENA

Long-term energy planning models

(time resolution: hours – seasons)

Geo-spatial planning models

(time resolution: hours – seasons)

Defining long-term capacity mix and transmission infrastructure

PLANNING FOR THE RENEWABLE FUTURE

LONG-TERM MODELLING AND TOOLS TO EXPAND VARIABLE RENEWABLE POWER IN EMERGING ECONOMIES

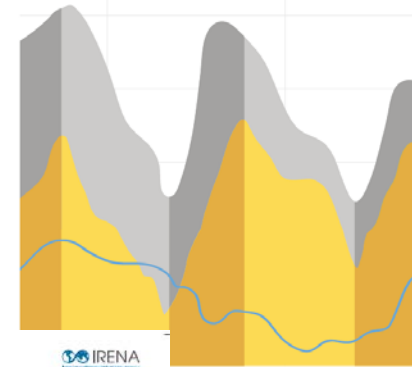

Production cost models

(time resolution: minutes – hours)

Static grid models

(time resolution: single point)

Dynamic grid models

(time resolution: milliseconds – minutes)

Grid integration studies for a given capacity and transmission infrastructure

TRANSFORMING SMALL-ISLAND POWER SYSTEMS

TECHNICAL PLANNING STUDIES FOR THE INTEGRATION OF VARIABLE RENEWABLES

EXECUTIVE SUMMARY



Forthcoming

Power sector transformation at IRENA

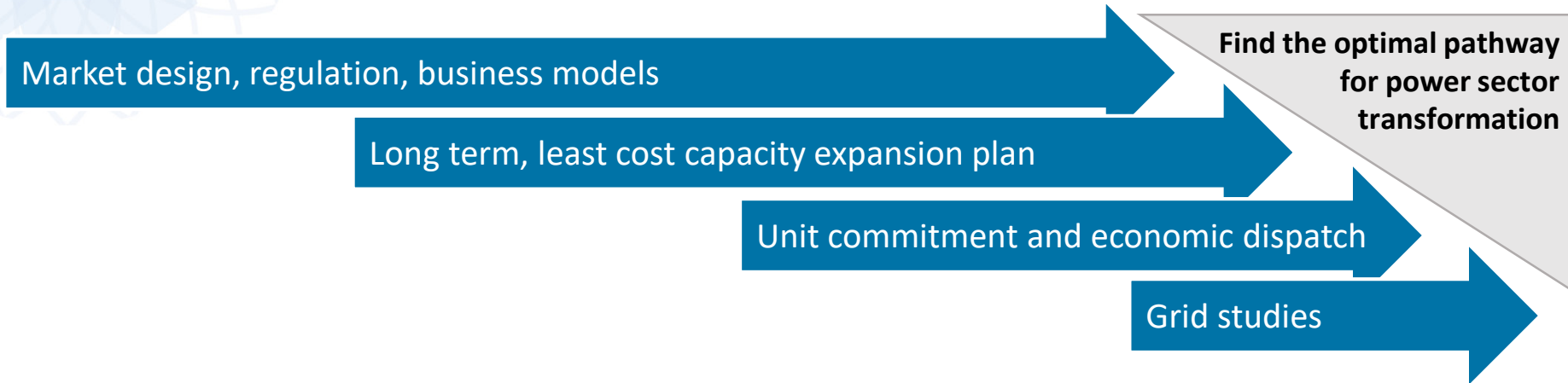

Strong focus on VRE integration issues

- » Work with countries in conducting planning studies with renewables using power sector modelling tools
- » Develop guidelines and tools to support better planning practices and disseminate them



IRENA

International Renewable Energy Agency

Thank you



1. Generation expansion planning: Tools

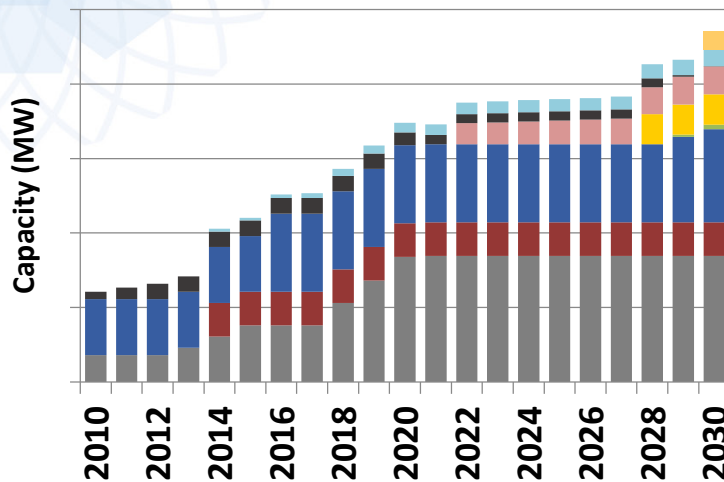

Generation expansion models, long-term energy planning models

- Long-term planning horizon (20-40 years ahead)
- Capacity build up with time steps of 1-5 years
- **Co-optimization of investment, dispatch, and transmission**
 - Limited time resolution (simplified representation of dispatch)
 - Limited spatial resolution (simplified representation of power flow)

2. Geo-spatial planning: IRENA's zoning assessment

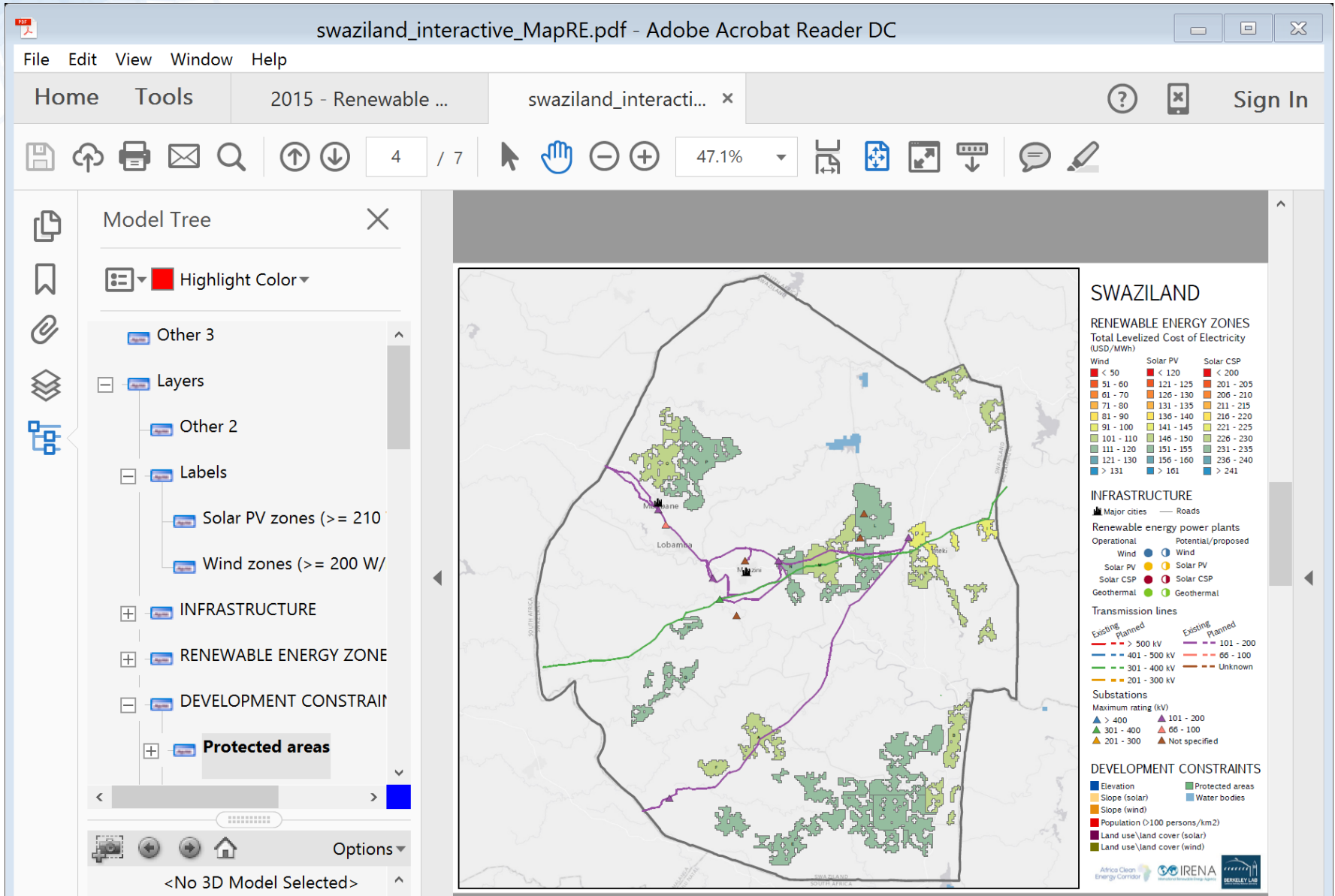

3. Dispatch simulation: Tools

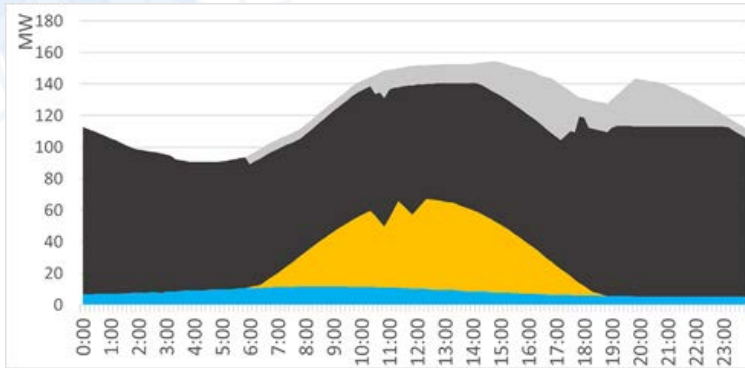

Production cost models, Unit commitment and economic dispatch models, Operational power system models, Market models

- Near to semi-long time horizon (several months to 20 years ahead)
- Used also for real-time operation decision making
- Capacity build up is often outside the scope
- Sub-hourly to hourly simulation for a period of up to a few years
- Network constraints are often taken into account

4. Technical network studies: Tools

Static network models

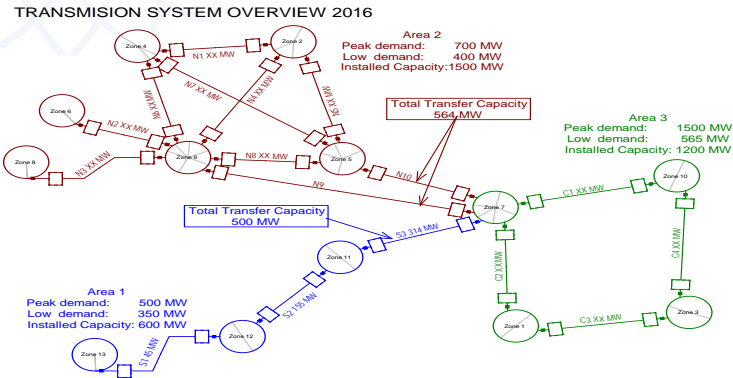

- Network topology and dispatch decision are given
- Real-time to semi-long time horizon (up to 20 years ahead)
- Snap shot analysis

Dynamic network models

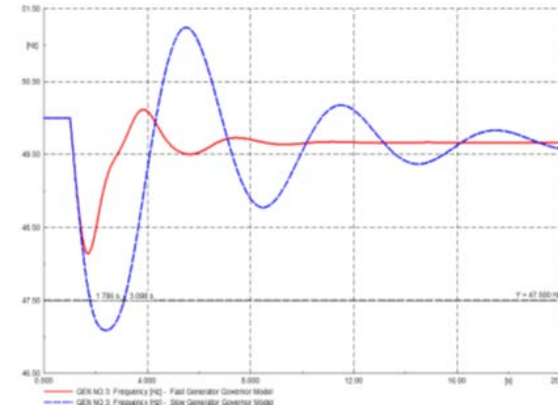

- Detailed network description is given
- Real-time to near term (up to a few years ahead)
- Dynamic analysis following a contingency event (millisecond to a few minutes)

Appendix A

RE costs development



Five key technical drivers of optimal VRE deployment in the long-term



- » Fast cost reduction
- » Firm capacity / capacity credit
- » Flexibility
- » Transmission investment needs
- » Stability consideration

Planning that takes into account long-term cost reduction potential can ensure long-term cost effectiveness of the energy system and avoid technology lock-in.

Recent cost evolution

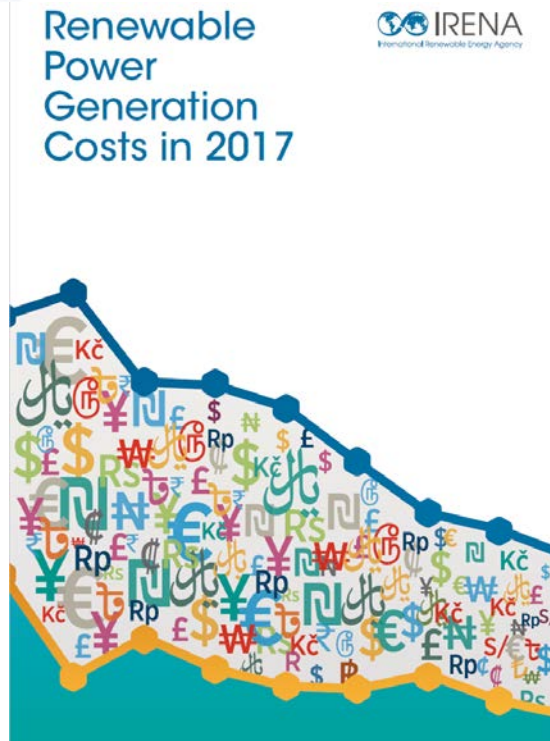

- » Latest trends in the cost and performance of renewable power generation technologies
- » Global results to 2017, country/regional results to 2016
- » Detailed analysis of equipment costs and LCOE drivers
- » Integration of project LCOE and Auction results to look at trends to 2020

Recent cost evolution

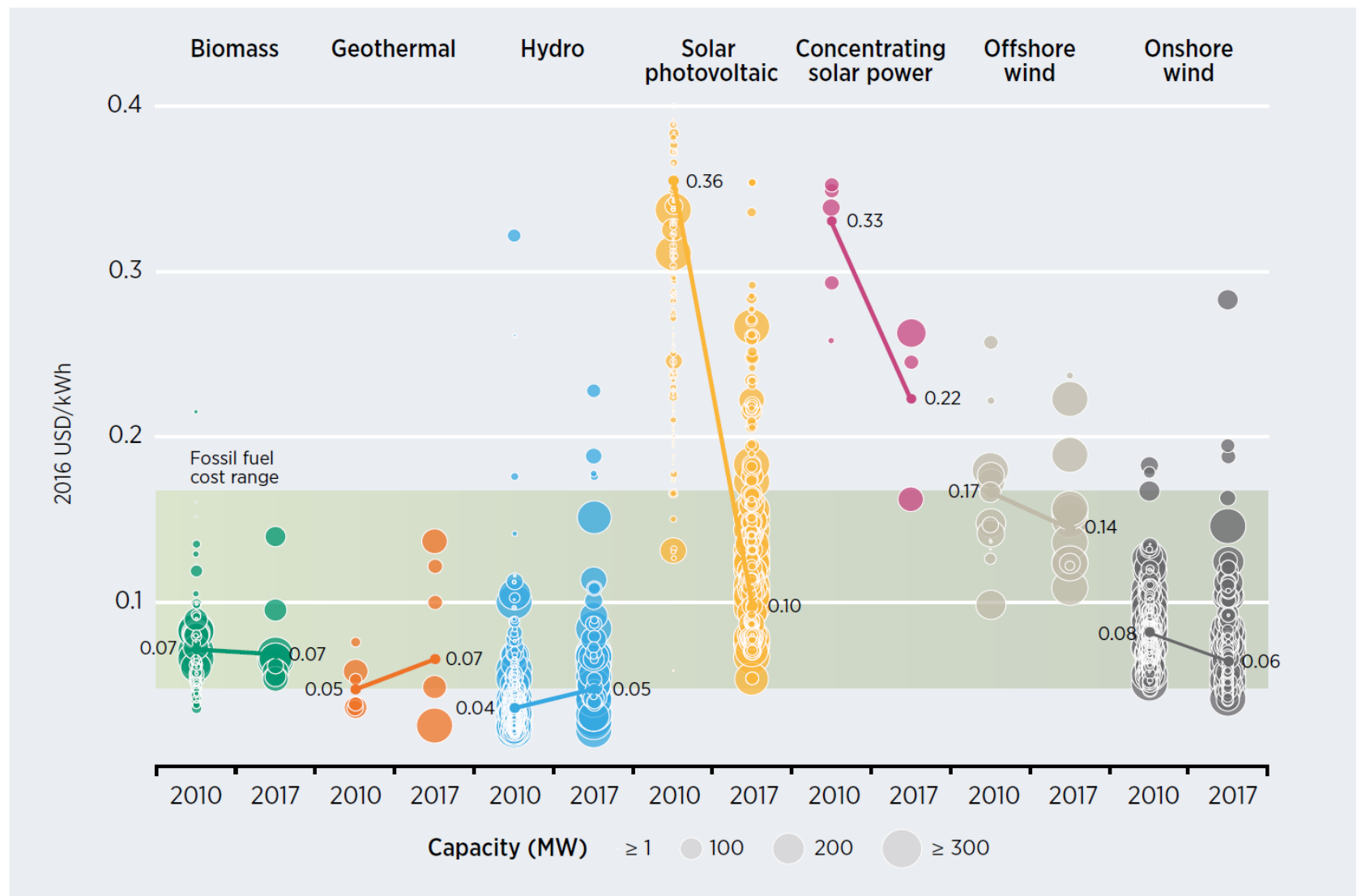

Source: IRENA Renewable Cost Database.

Power sector planning: Planning scopes for techno-economic analysis

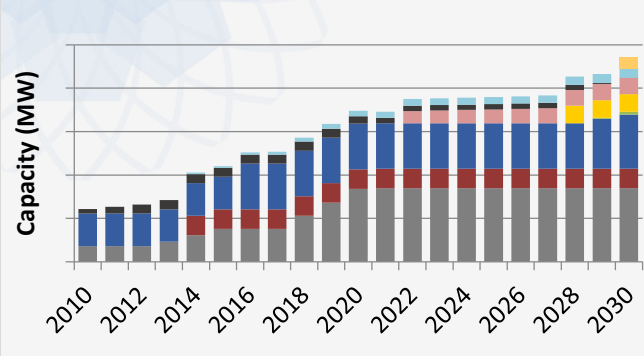

Generation expansion planning

- Ministry of Energy
- Planning agency
- Utility

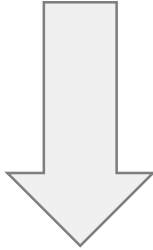

Dispatch simulation

- Utility
- Regulators
- TSO

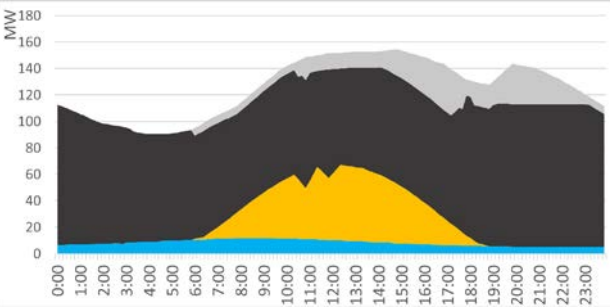

Geo-spatial planning

- Ministry of Energy
- Planning agency
- Utility
- TSO

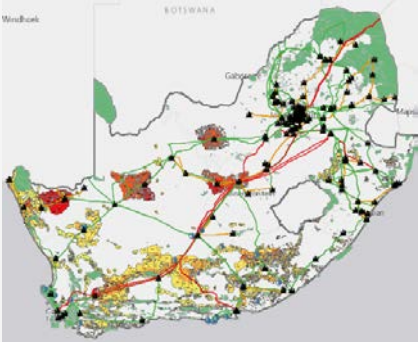

Technical network studies

- TSO
- Regulator
- Project developer

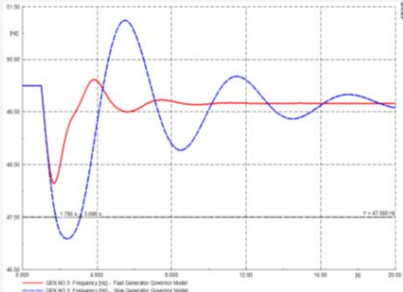

1. Generation expansion planning

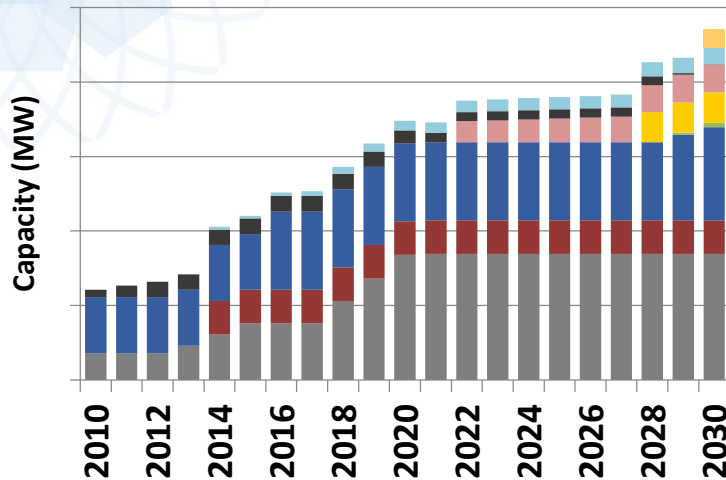

- Future energy mix and investment path
- Compliance with long-term energy policy goals
- Political consensus making
- Linked often with non-power sector planning

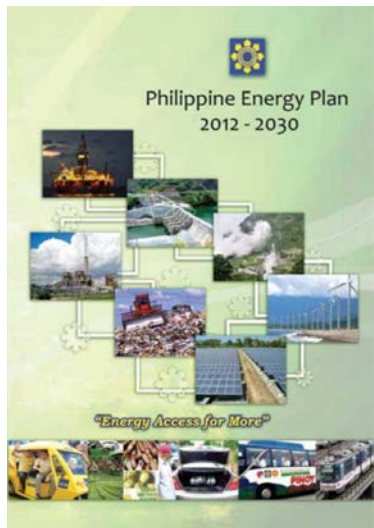

Department of Energy



Regulatory commission

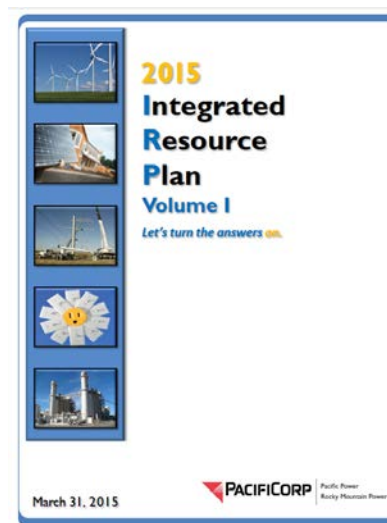

Utility



Specialized agency

2. Geo-spatial planning

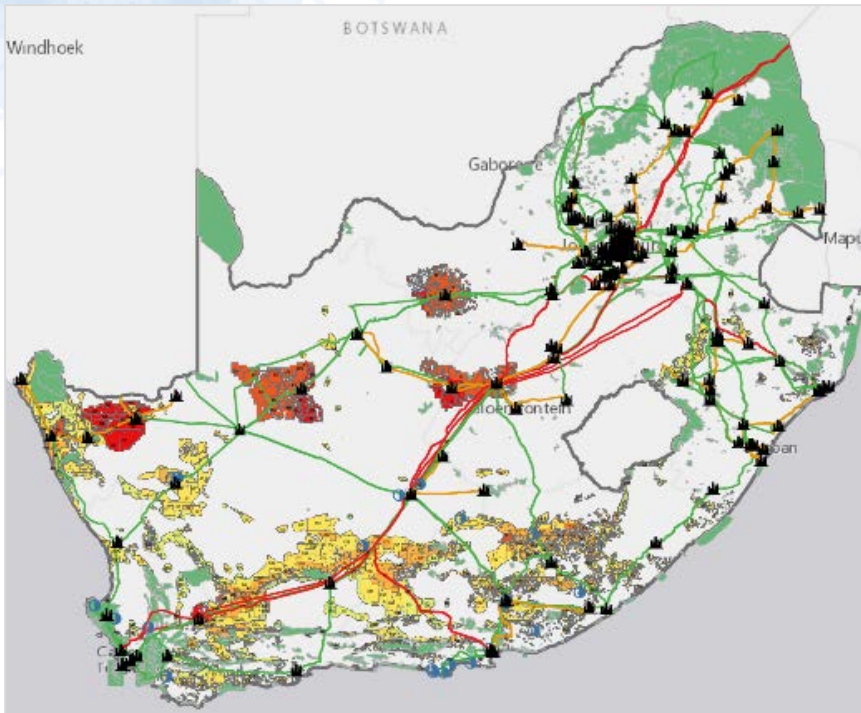

- Generation siting and long-term transmission development needs
- High-level screening scenarios for transmission network development
- Zone identification for investment promotion

Tools:
Maps, Geographical Information System (GIS)



3. Dispatch simulation

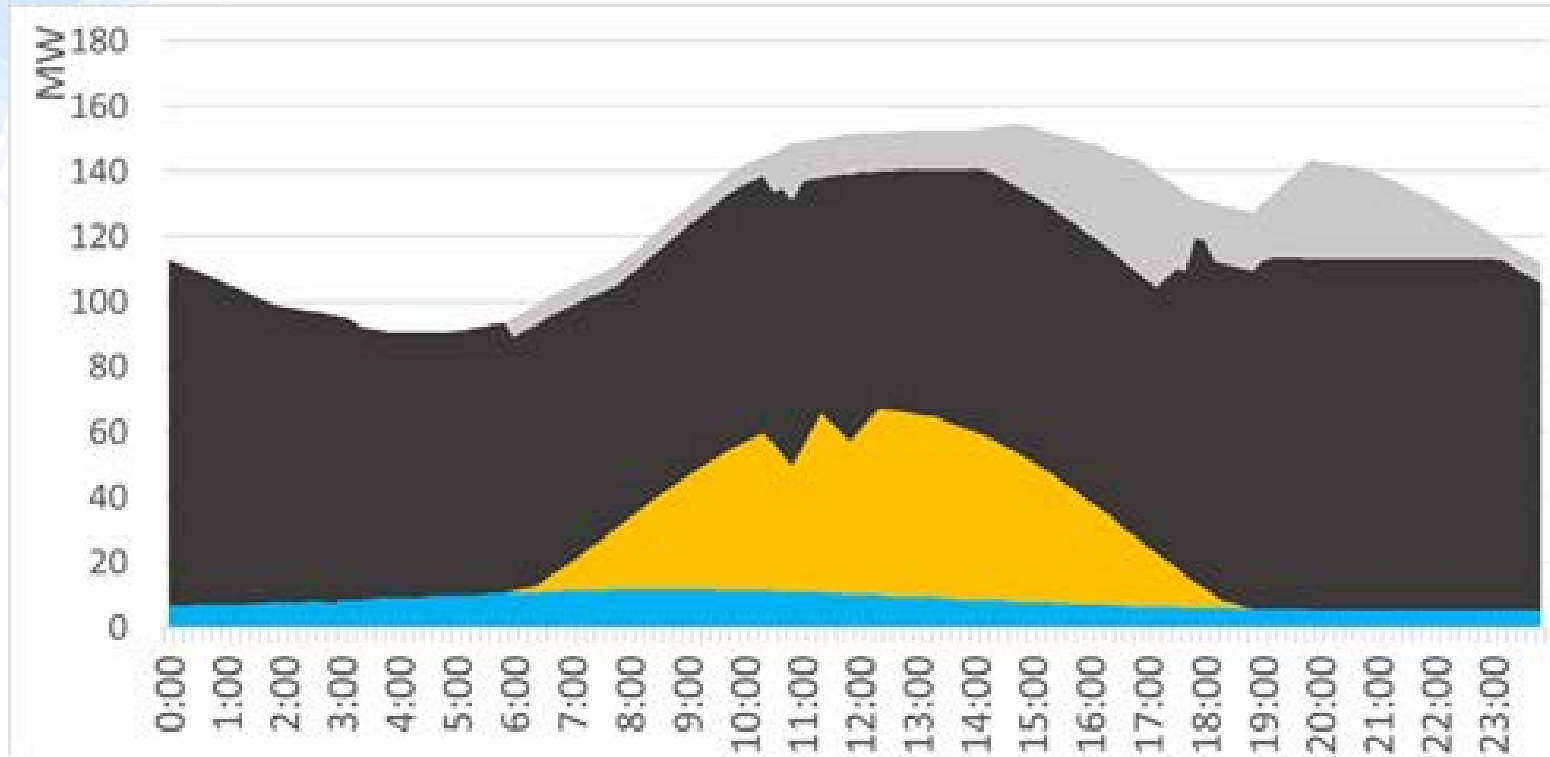

- Fuel and operation cost calculation
- Maintenance scheduling
- Economic power flow
- Market and regulation design
- VRE integration study

4. Technical network studies

TRANSMISSION SYSTEM OVERVIEW 2016

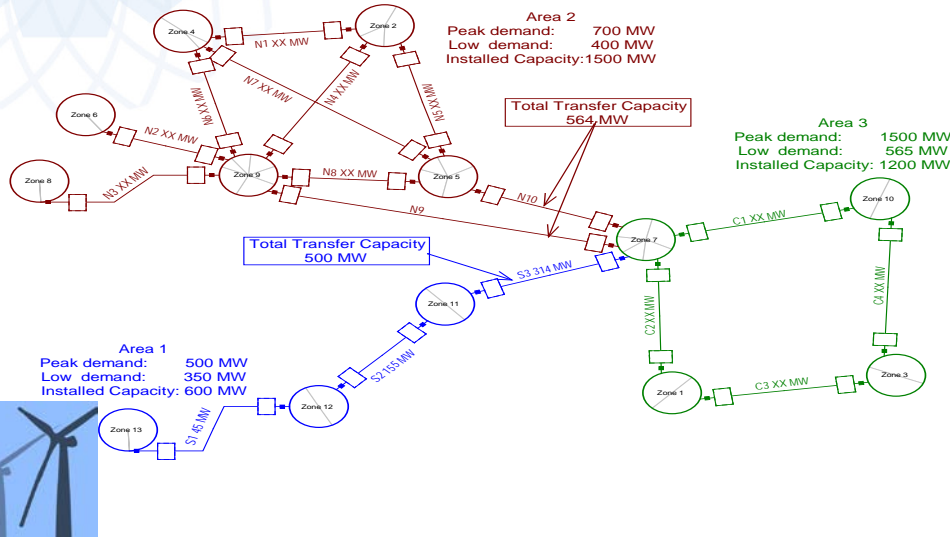

Load flow analysis

- Simulate power flow of a given network under a challenging situation
- Identify network enhancement needs
- VRE integration study

Stability assessment

- Simulation of frequency and voltage response in a network to a contingency event
- VRE integration study

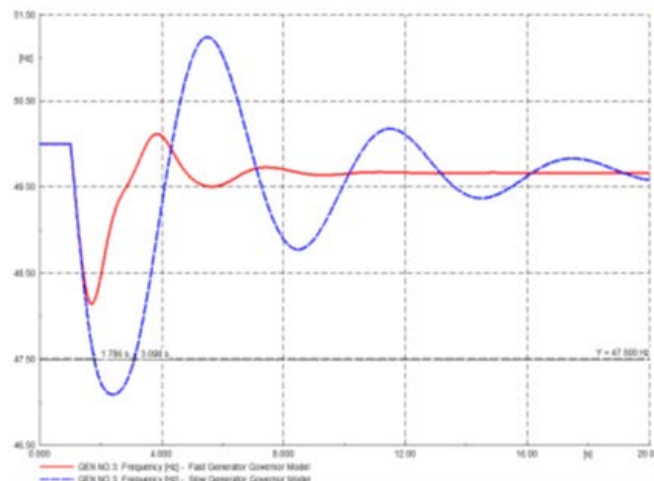

RE costs and auction results are now at or below fossil fuel cost range

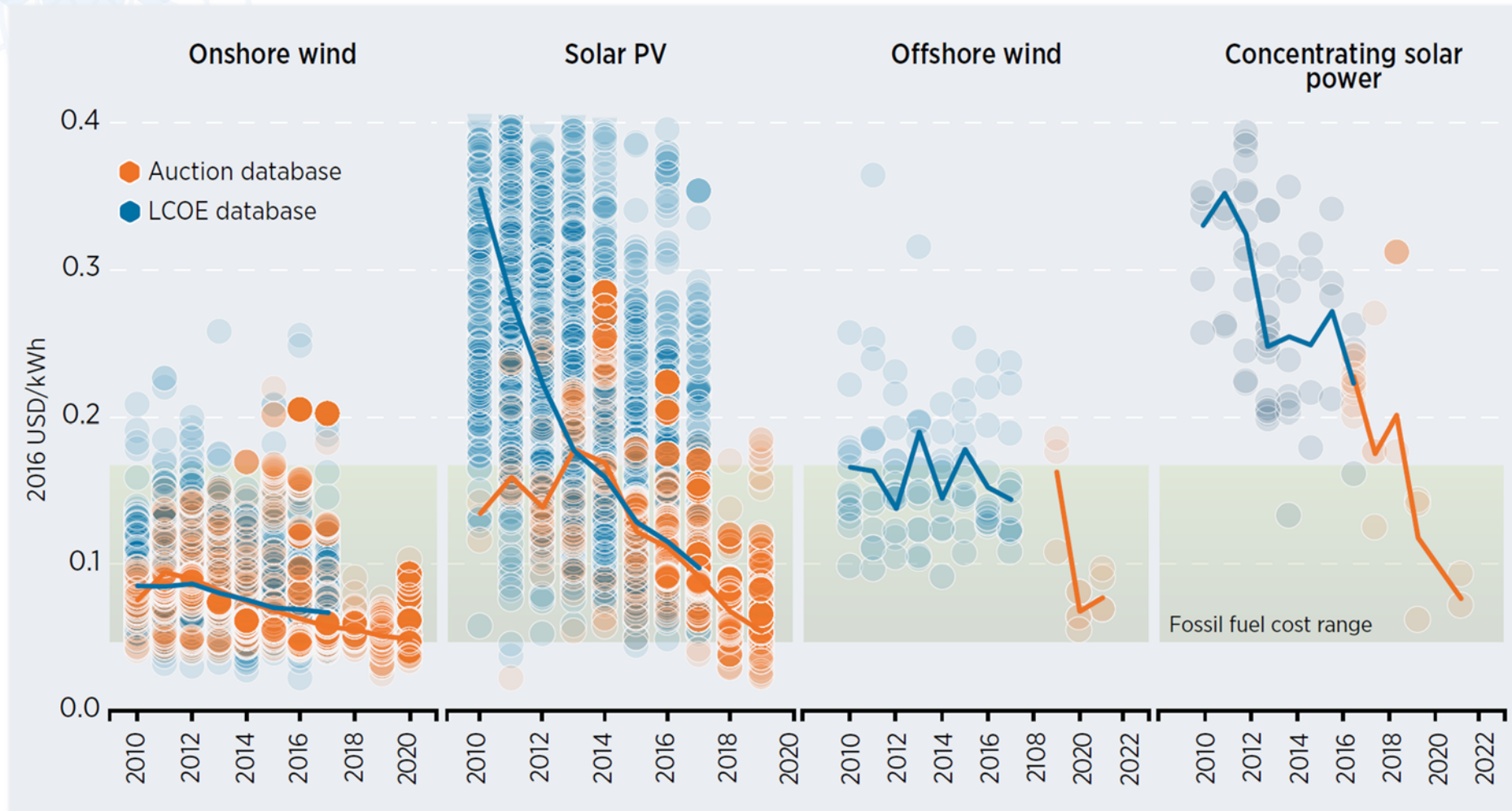

How reality surpassed expert projections: e.g. solar PV costs

AEO: Annual Energy Outlook from US EIA

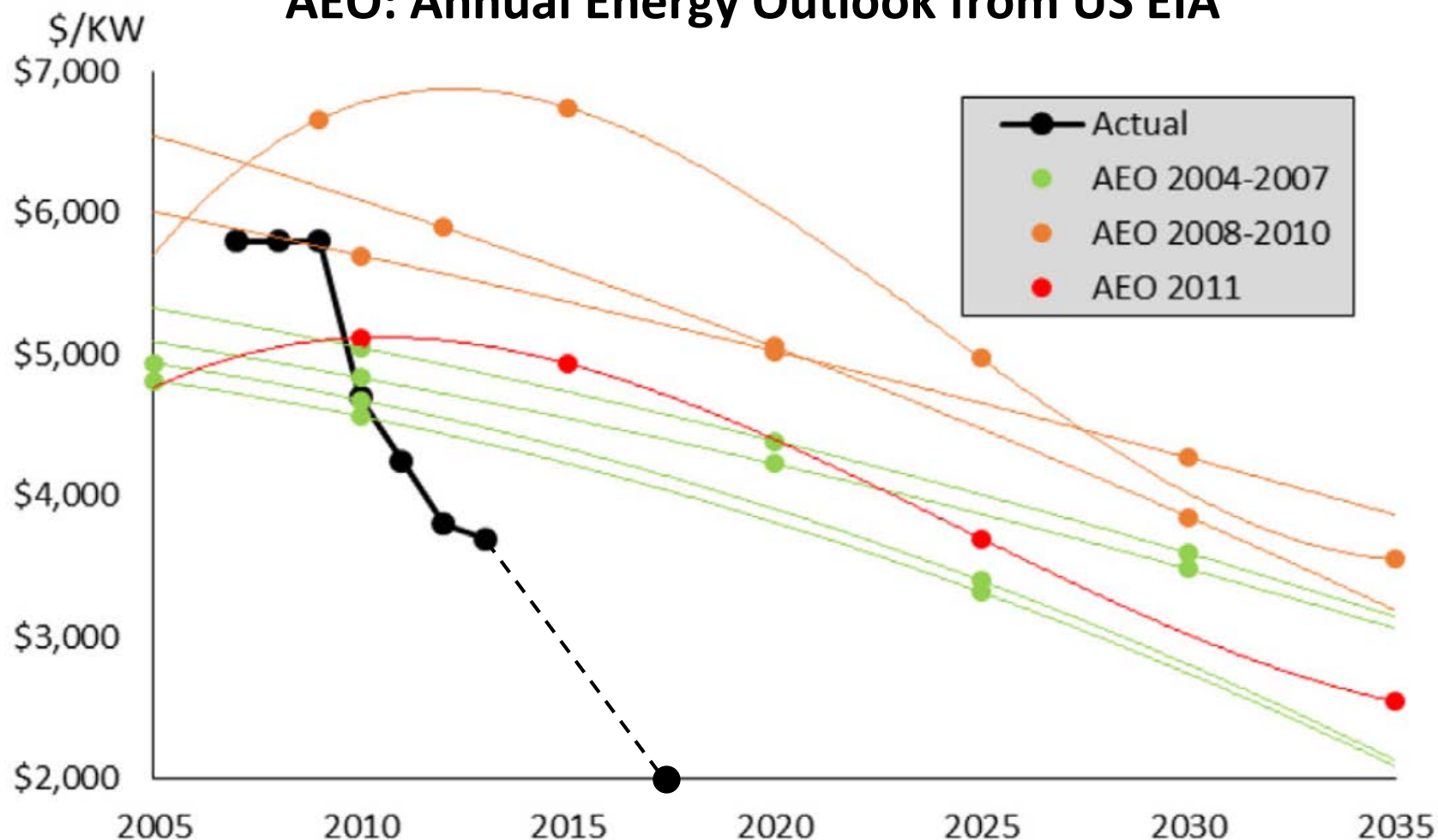

Source: Metayer et. al (2016), The projections for the future and quality in the past of the World Energy Outlook for solar PV and other renewable energy technologies; and Gilbert et. al (2016), Looking the wrong way: Bias, renewable electricity, and energy modelling in the United States

Appendix B

IRENA Project Facilitation



The RE Project Development Challenge

- » Most countries know they have RE potentials. However, they lack the projects to achieve the desired deployment.
- » Conditions inherent to certain countries/regions translate into high costs and risks, e.g. SIDS.
- » Stakeholders involved in a project often lack the know-how to complete a bankable project proposal.
 - » This leads to higher project development costs and risks.
- » Fund securement process and financing options themselves aren't transparent.



- ➔ **IRENA aims to strengthen the project development base and improve the bankability and visibility of projects, facilitating the financial closure process and increasing the number of successful projects on the ground.**

IRENA Project Facilitation: Online Project Navigator Platform

IRENA Project Navigator

REGISTER
FOR FREE

Learn

- » Project development process guidance
- » Technical concept guidelines
- » Tools, templates and case studies



Develop

- » Interactive workspace to build a successful renewable energy project proposal
- » Apply custom project details and track progress



Finance

- » Simplified connection with financing instruments



European Investment Bank
EU-Africa Infrastructure Trust Fund (ITF)



THE WORLD BANK
IBRD • IDA | WORLD BANK GROUP

World Bank
Clean Technology Fund (CTF)



GEF secretariat
Global Environment Facility

IRENA ADFD
Supporting Energy Transition

IRENA and ADFD
IRENA/ADFD Project Facility

IRENA Project Navigator

Objectives

- » Increase the bankability of projects by:
 - » Enhancing Technical, Environmental, Social, Economic and Financial parameters,
 - » Reducing costs and mitigating risks through proper planning and efficient use of funds
 - » Facilitating effective implementation

Renewable energy technology coverage



On-shore wind



Solar PV



Bioenergy



Small Hydro



Solar home systems



Mini-grids



Geothermal

Project Navigator Platform



Learning Section

- » Project development and technical guidelines
- » Best practices
- » Examples & Case Studies

Start a Project

- » Personal and private workspace
- » Tools, templates, checklists
- » Stepwise approach
- » Track your progress
- » Export documents

Financial Navigator

- » Information on multiple funds
- » Filter by region and technology
- » Information includes fund types, requirements and contact details among others.

Technical Concept Guidelines

Scope

- » Technology evaluation
- » Technical Project planning and design
- » Technical aspects for Financial closing
- » Project execution and commissioning
- » O&M

Main Features

- » Minimum requirements for bankability of a project
- » Comparison of possible options
- » Case studies and tools
- » Financial model
- » Lessons learned / Do's and Don't's from previous projects



- » Realization of risks can affect the profitability of a project:
 - » Lower than expected revenues
 - » Higher than expected costs
 - » Delay of incoming cash flows
 - » Loss of assets
- » The bankability of a project will depend heavily on how well these risks are managed
- » Risk assessment and risk management is extremely important
- » Standards and quality assurance are essential to assure the safe and reliable performance and safety of a PV plant



Appendix C

Standards, Quality Assurance, and Quality Infrastructure



Supporting countries to develop and implement Quality Infrastructure for RE

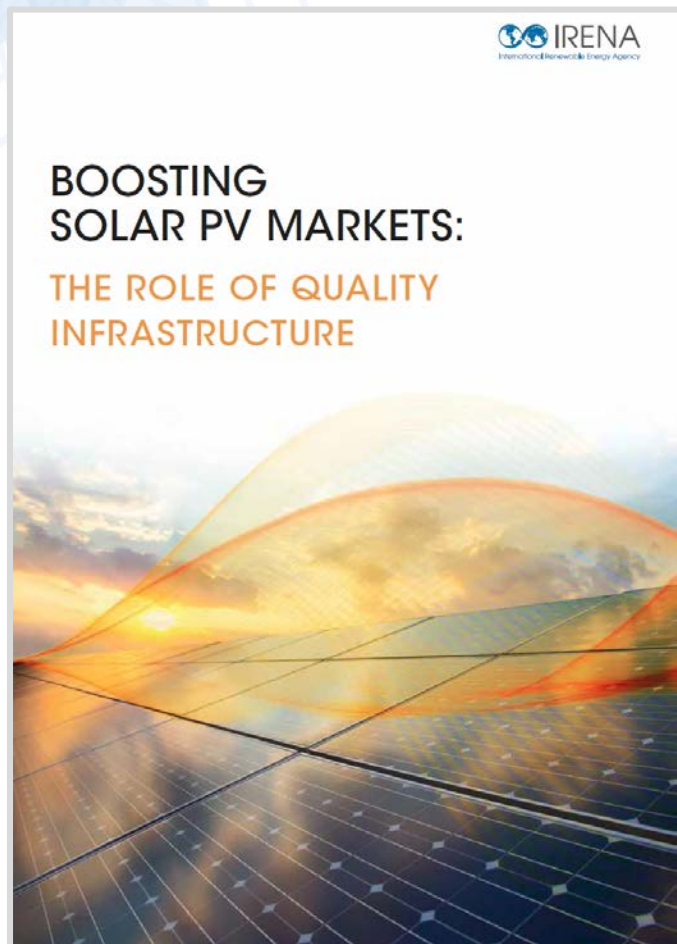

<http://Inspire.irena.org>

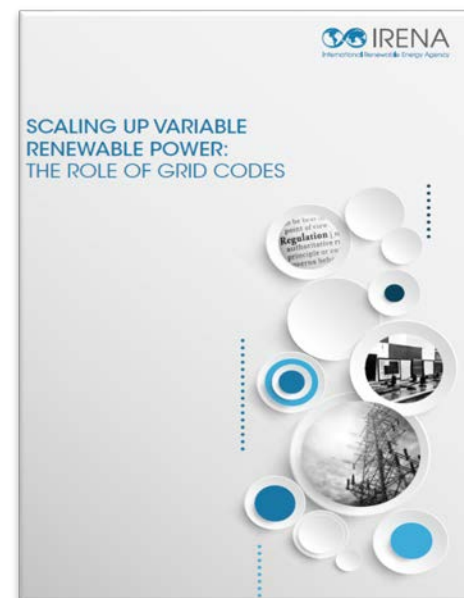

Download for free today:
www.irena.org/publications



IRENA - Cooperation in Quality Assurance & Standards

Requests

- ✓ **China:** Technical standards for Offshore Wind technology
- ✓ **Japan:** quality control for PV and Wind technologies in extreme weather conditions
- ✓ **Latin American region:** In cooperation with PTB, quality control for solar thermal and PV systems
- ✓ **MENA region:** In cooperation with EU GCC testing for PV systems
- ✓ **UAE:** International Standards for PV systems
- ✓ **Mauritania:** Request for support on grid connection codes
- ✓ **Colombia:** Grid codes
- ✓ **Tanzania:** Solar thermal

- ✓ **International Electrotechnical Commission - IEC:** Workshops for Countries on use of standards, INSPIRE



- ✓ **German Metrology Institute- PTB:** Quality infrastructure support, Workshop in Costa Rica, Green climate dialogue in Germany



- ✓ **ENTSO-E, SolarPower Europe and Solar United:** PV and grid codes



- ✓ **Solar Bankability**

- ✓ **WWEA:** Standards in small wind technologies



- ✓ **EU GCC Clean Energy Technology Network :** GCC Inception meeting & training-Solar Photovoltaic Testing Centres Network



Appendix D

Additional IRENA costing information



Solar PV Cost Trends

Total installed cost

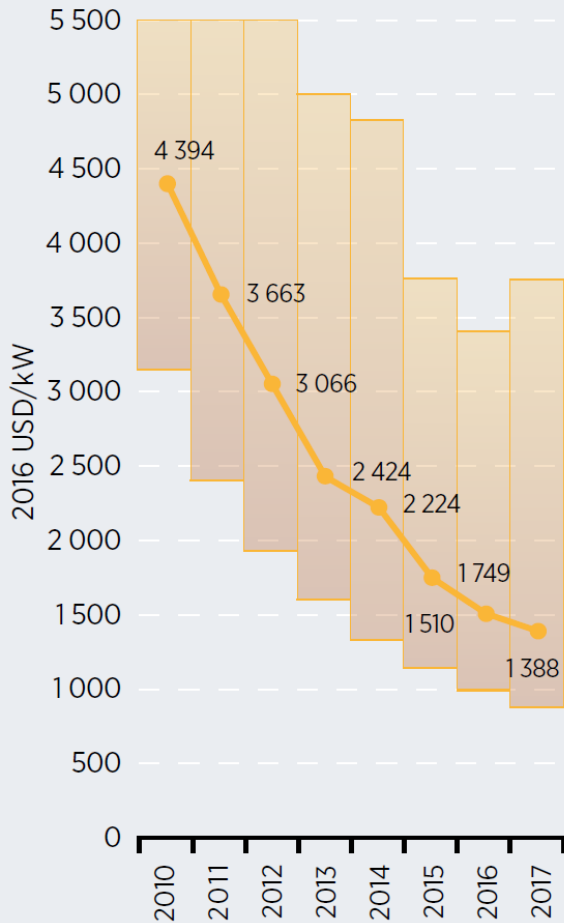

Capacity factor

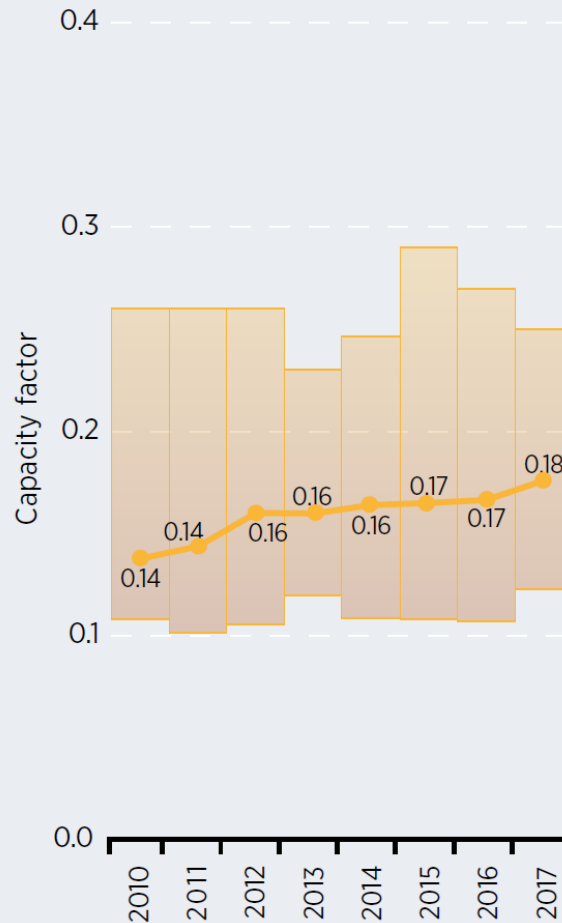

Levelised cost of electricity

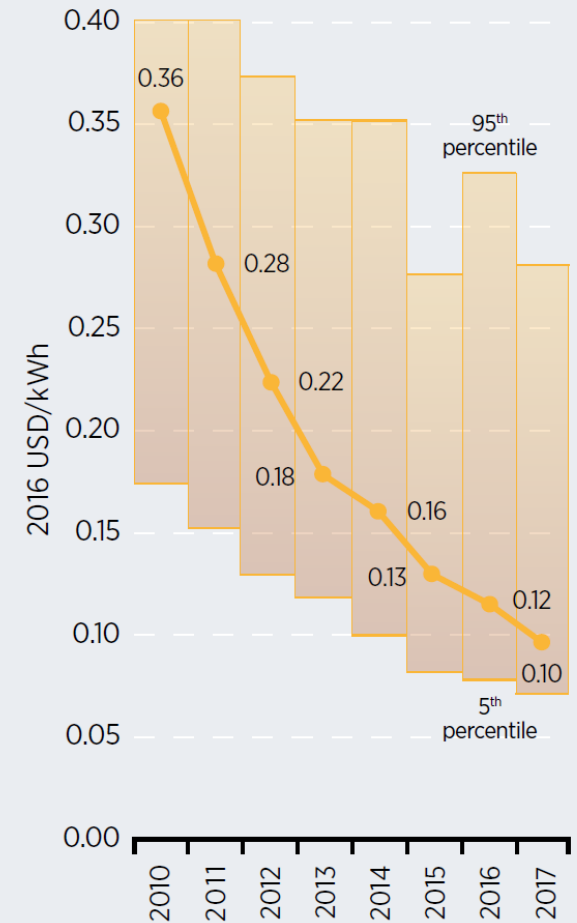

Onshore Wind Cost Trends

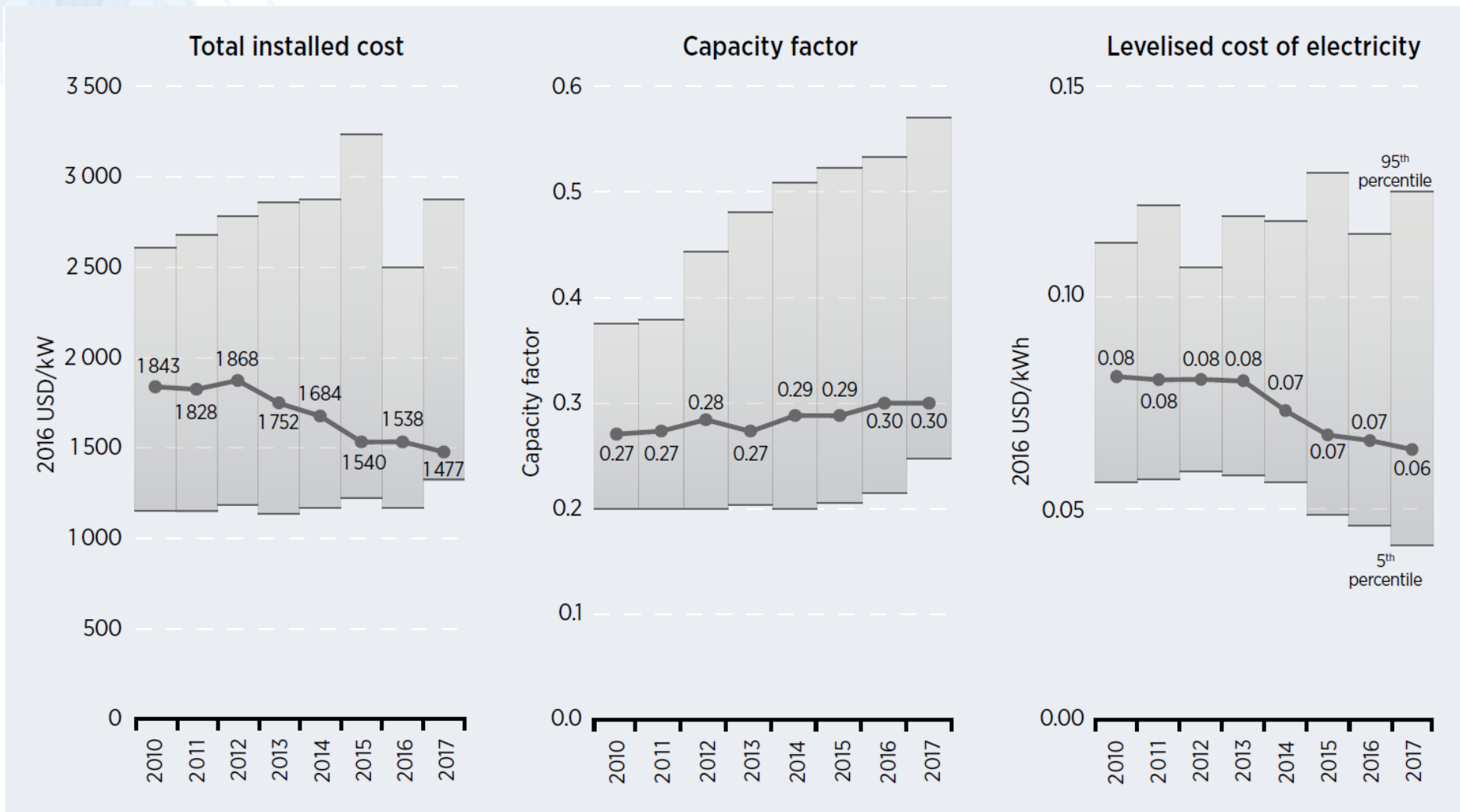

Source: IRENA Renewable Cost Database.

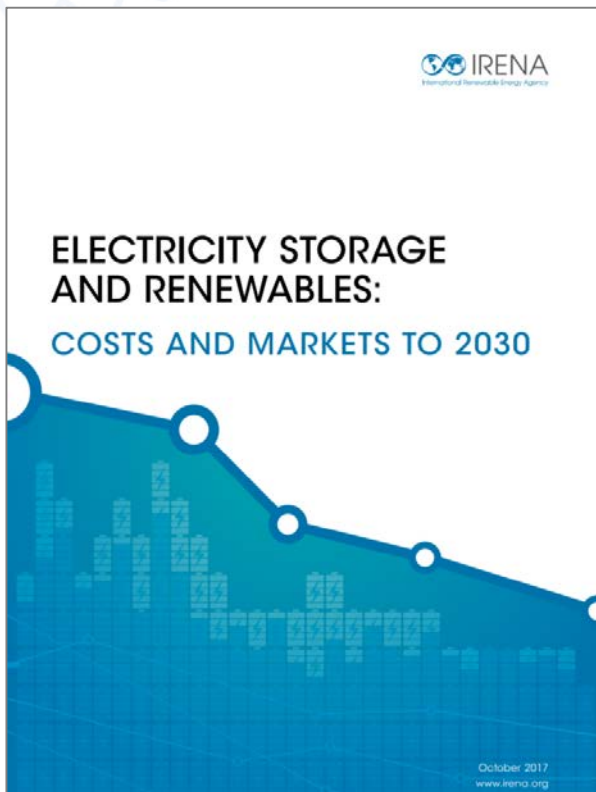

Electricity Storage:

AT THE HEART OF THE ENERGY SECTOR TRANSFORMATION

Current prices of different storage technologies

Current energy installations costs (USD/kWh of storage) Reference case 2016

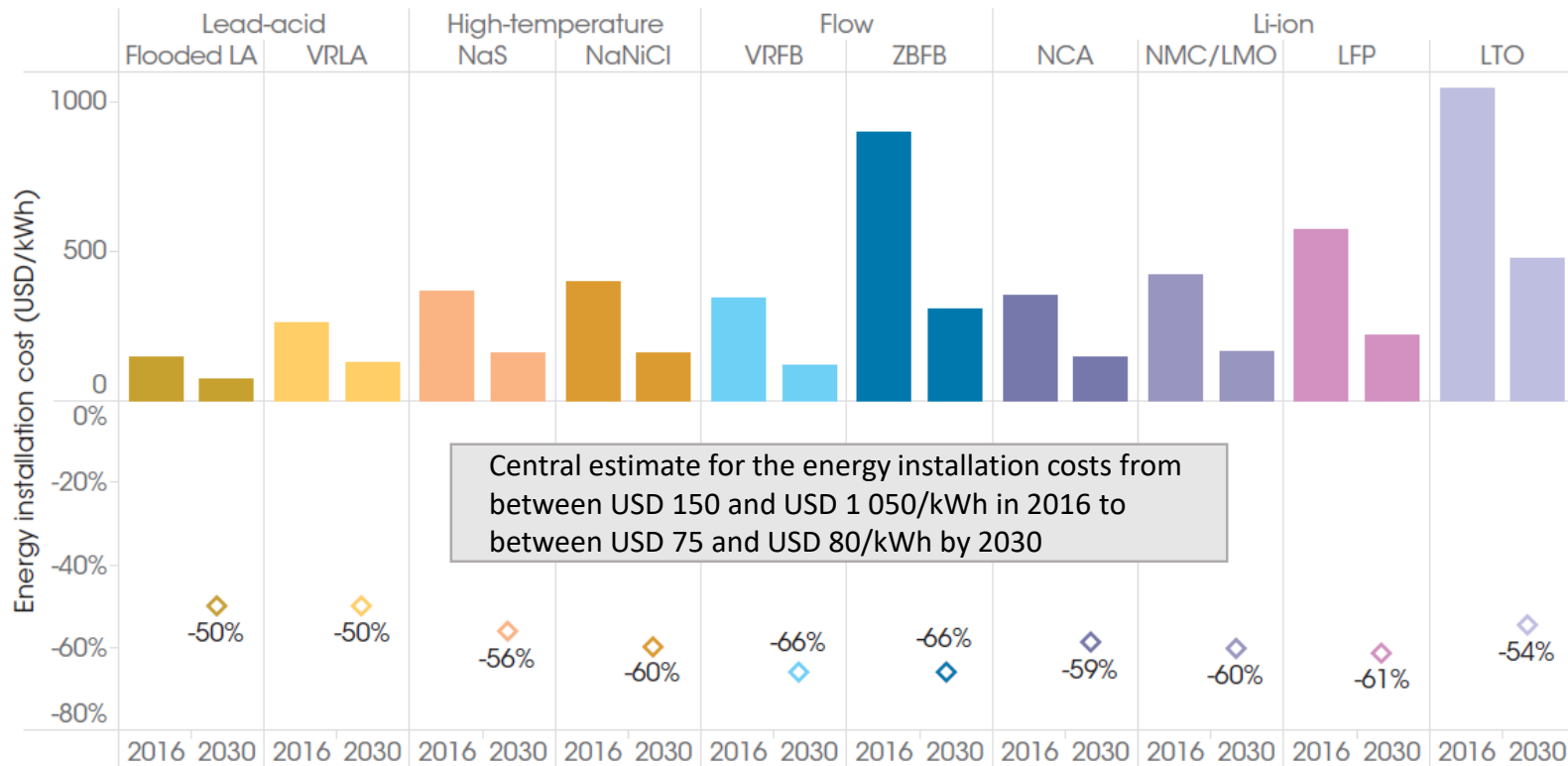

Central estimate for the energy installation costs from between USD 150 and USD 1 050/kWh in 2016 to between USD 75 and USD 80/kWh by 2030

The total installed cost of a Li-ion battery could fall by an additional 54-61% by 2030 in stationary applications

A drop for Li-ion batteries for stationary applications to between USD 145 /kWh and USD 80/kWh

Note: LA = lead-acid; VRLA = valve-regulated lead-acid; NaS = sodium sulphur; NaNiCl = sodium nickel chloride; VRFB = vanadium redox flow battery; ZBFB = zinc bromine flow battery; NCA = nickel cobalt aluminium; NMC/LMO = nickel manganese cobalt oxide/lithium manganese oxide; LFP = lithium iron phosphate; LTO = lithium titanate.

Cost reduction drivers of battery electricity storage systems

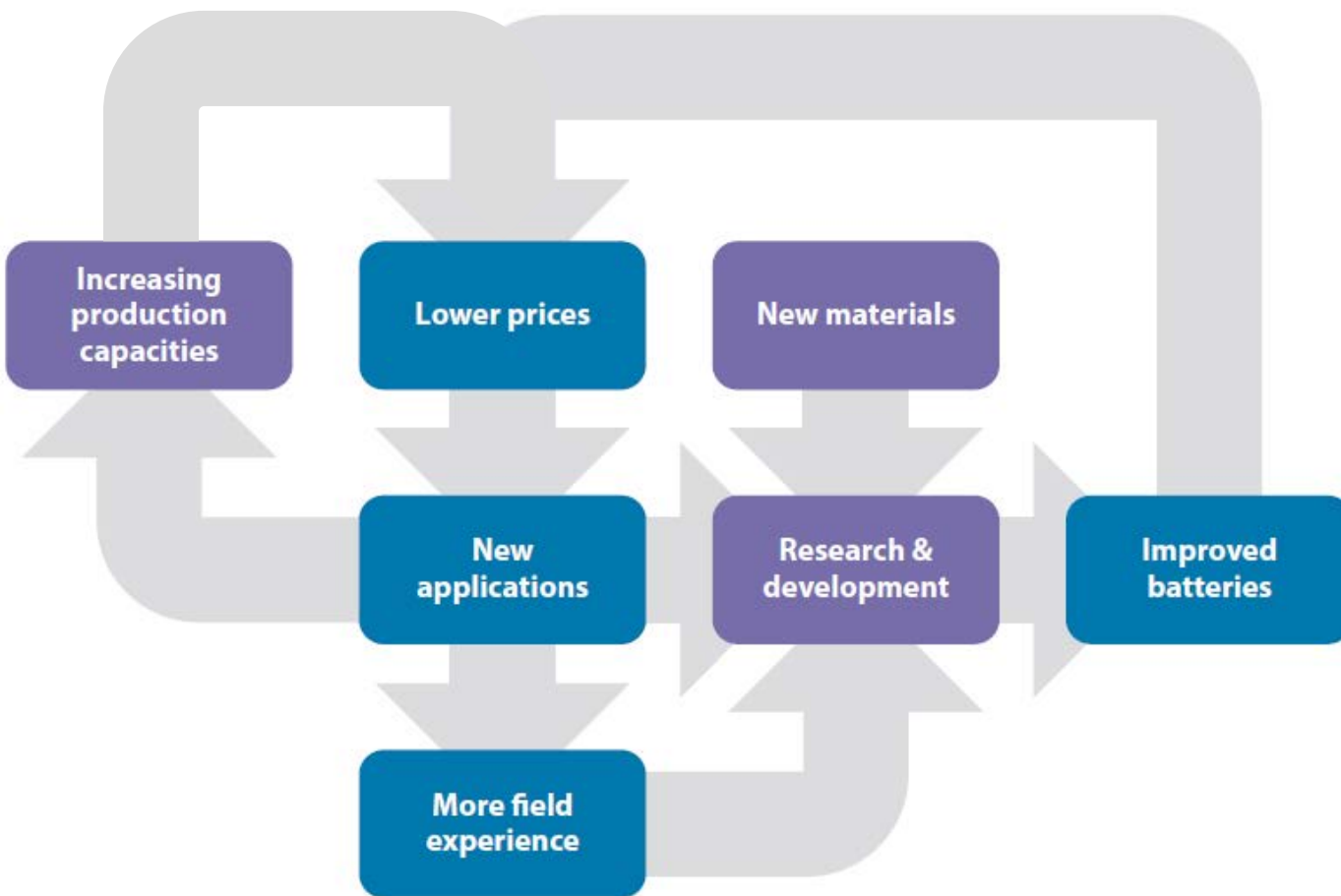

Drivers are not exclusive to Li-ion (or batteries in general), as other technologies are likely to experience a similar dynamic as their deployment grows.

However, with the dominance of Li-ion batteries in the EV market and the synergies in the development of Li-ion batteries for EVs and stationary applications the scale of deployment that Li-ion batteries likely to be of magnitude higher than for other battery technologies.

A new CEM campaign

Long-term energy scenarios for the clean energy transition (LTES)

- » **Launch:** May 2018 at the 9th CEM meeting, Copenhagen
- » **Duration:** one year (possible extension to multiple years)
- » **Lead countries:** Denmark, Germany
- » **Operating agent:** IRENA



Denmark



Germany

Goal: promote the wider adoption and improved use of long-term energy scenarios for clean energy transition

State participants joining campaign:



Brazil



Mexico



Chile



The Netherlands



Finland



European Commission



United Arab Emirates



United Kingdom



Japan

Summary from “*Planning renewable energy strategies: Africa power sector, Achievements and way forward*”, Abu Dhabi January 2015



Long-term energy planning, if done properly,

- » Creates consensus among stakeholders
- » Can help to avoid costly investment mistakes
- » Reduces uncertainties in policy directions/project selection
- » Sends investors signals on types & quantity of investment needs
- » Accelerate service delivery

Latin American context

Summary from ““Exchanging best practices to incorporate variable renewable energy into long-term energy/power sector planning in South America”



Colombia:

Basis for policy making, establishing **signals for investment** and capacity expansion needs

Brazil:

To be used as a **basis for formulating public policies**

Uruguay:

To design policies to support technologies to promote and **investment needs**

Argentina:

To establish a framework of discussion for the **design of new policies** and for the **discussion with actors of the sector.**

Planning reports from governments in LATAM

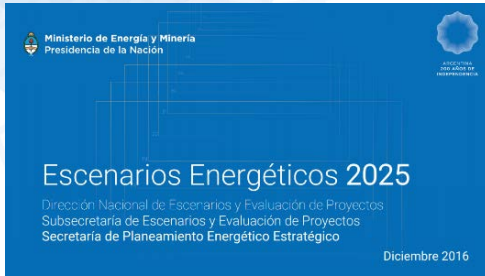

Argentina

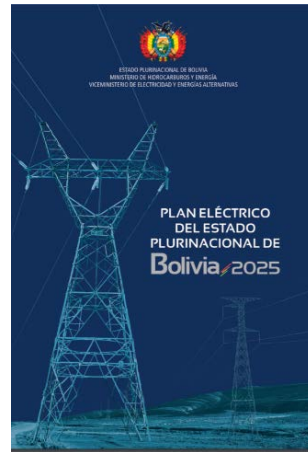

Bolivia



Brazil

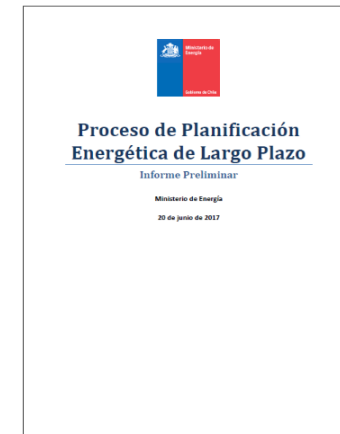

Chile



Paraguay

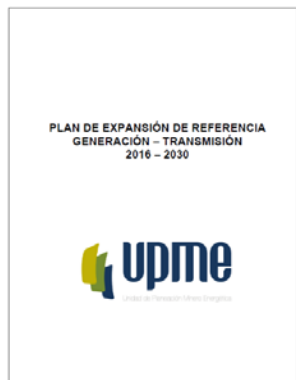

Colombia



Ecuador

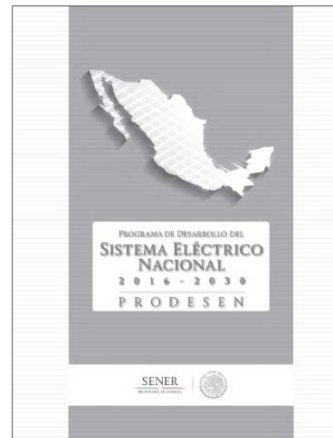

Mexico

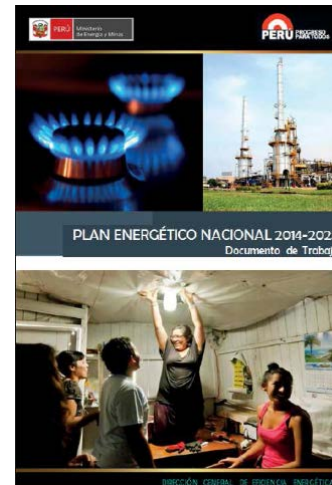

Peru

Planning scopes in LATAM

Country	Scope	Planning horizon	Update
Argentina	Energy	2025	Annual
Bolivia	Electricity	2025	NA
Brazil	Energy	2050	5 -10 years
Chile	Energy	2046	5 years
Colombia	Electricity	15 years	Annual
Ecuador	Electricity	2025	2 years
Mexico	Electricity	15 years	Annual
Paraguay	Energy / electricity	2040 / 2025	5 / 2 years
Peru	Energy	10 years	2 years
Uruguay	Energy / Electricity	2035 / 2040	Annual