



# Energy Storage: a Key Flexibility Resource



**Patrick Clerens**  
**Secretary General, EASE**

07 November 2018  
IRENA South East Europe Workshop on  
Grid Integration of Variable Renewable  
Energy Sources, Vienna



# 1. Introduction to EASE

## European Association for Storage of Energy...

- ...is the European **voice** of the energy storage community
- ...advocates the **role of energy storage** as an indispensable instrument for the energy system
- ...supports a **sustainable**, **flexible** and **stable** energy system
- ...**shares** and **disseminates** information

### Strategic objectives:

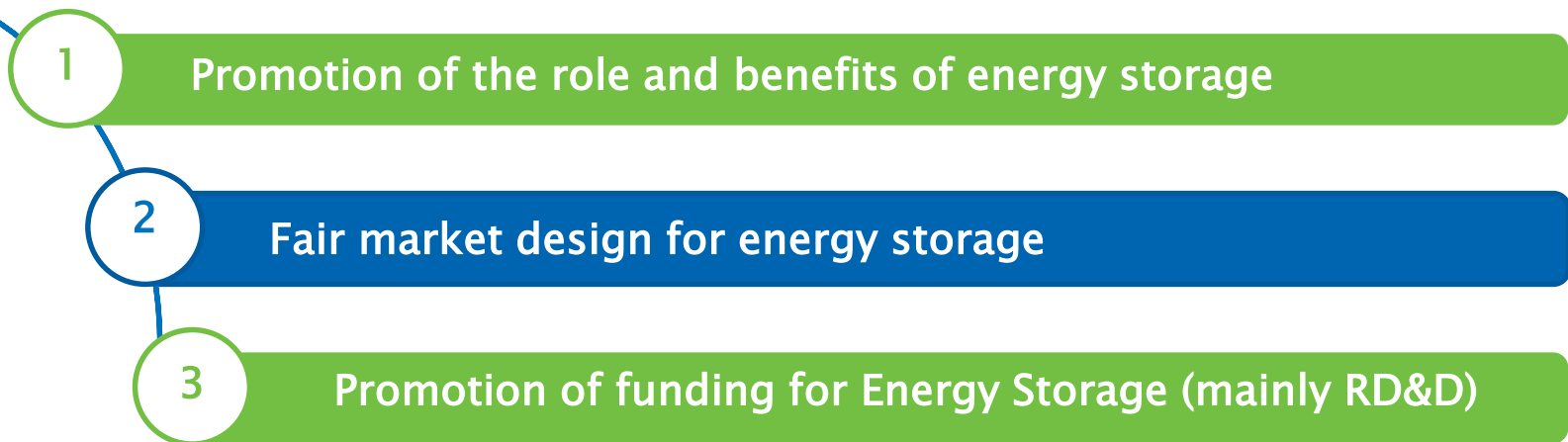



# 1. Introduction to EASE

## EASE Members





## 2. Why Do We Need Storage?

### Paris Agreement and Decarbonisation Goals

- At the Paris climate conference (COP21) in December 2015, 195 countries adopted the first-ever universal, legally binding global climate deal.
- The agreement sets out a global action plan to put the world on track to avoid dangerous climate change by **limiting global warming to well below 2°C**.
- **The Paris Agreement will have long-term effects on governments, citizens and companies.**

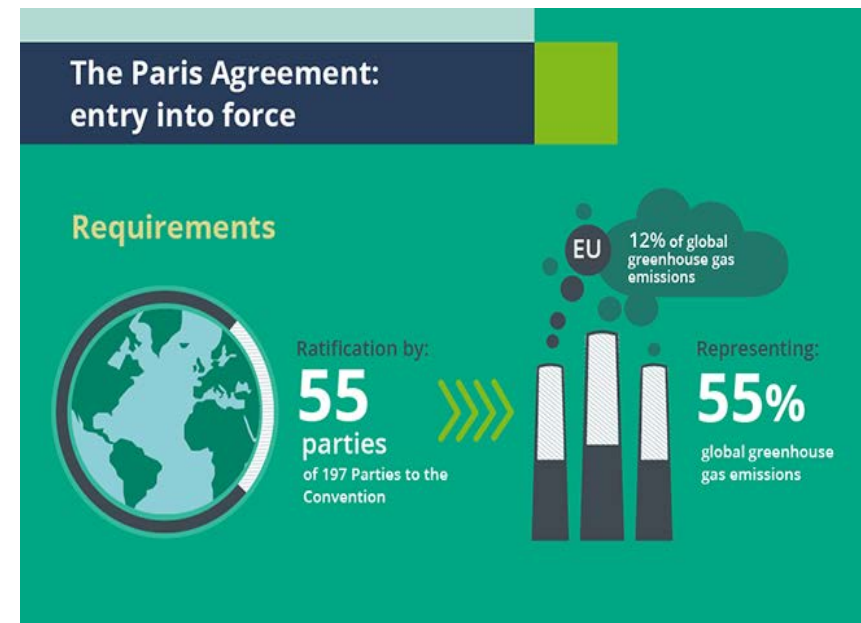



## 2. Why Do We Need Storage?

### Decarbonisation and the Energy Union – Example: Germany



**Maximum peak demand**

Source: German TSOs (2016)

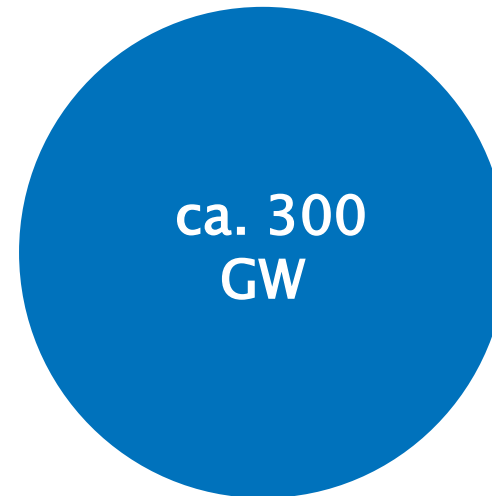

**RES installed capacity needed to cover peak demand**

Source: Sachverständigenrat für Umweltfragen (SRU): Wege zur 100% erneuerbaren Stromversorgung.

**How to maximise the use of RES to meet EU decarbonisation goals?**



## 2. Why Do We Need Storage?

Balancing Generation and Consumption at all Times

Belgian Wind Power Forecasting – 02.09.2018



- Measured & Upscaled
- Most recent forecast

Source: Elia, données de production éolienne

**This challenge becomes more difficult the more variable renewables (vRES) you have in the system.**



## 2. Why Do We Need Storage?

### Available Flexibility Options to Integrate Variable Renewables



Uncertainties about practicability...has yet to demonstrate full potential

Social acceptance becoming increasingly limited

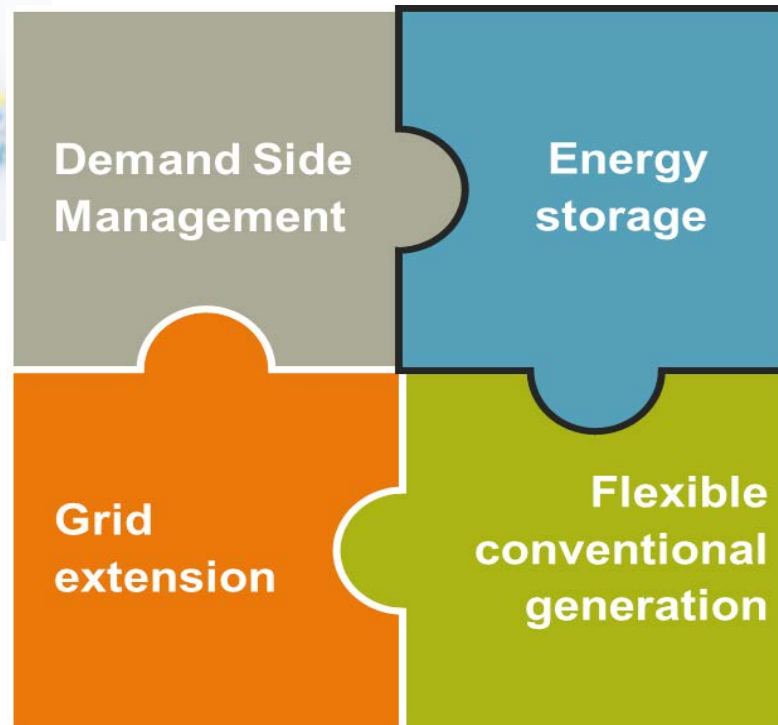

Many available technologies, value for host of different applications and locations.

Concerns about the environmental impacts and sustainability



# 3. Technologies and Applications

Many Energy Storage Technologies on the Market and in R&D

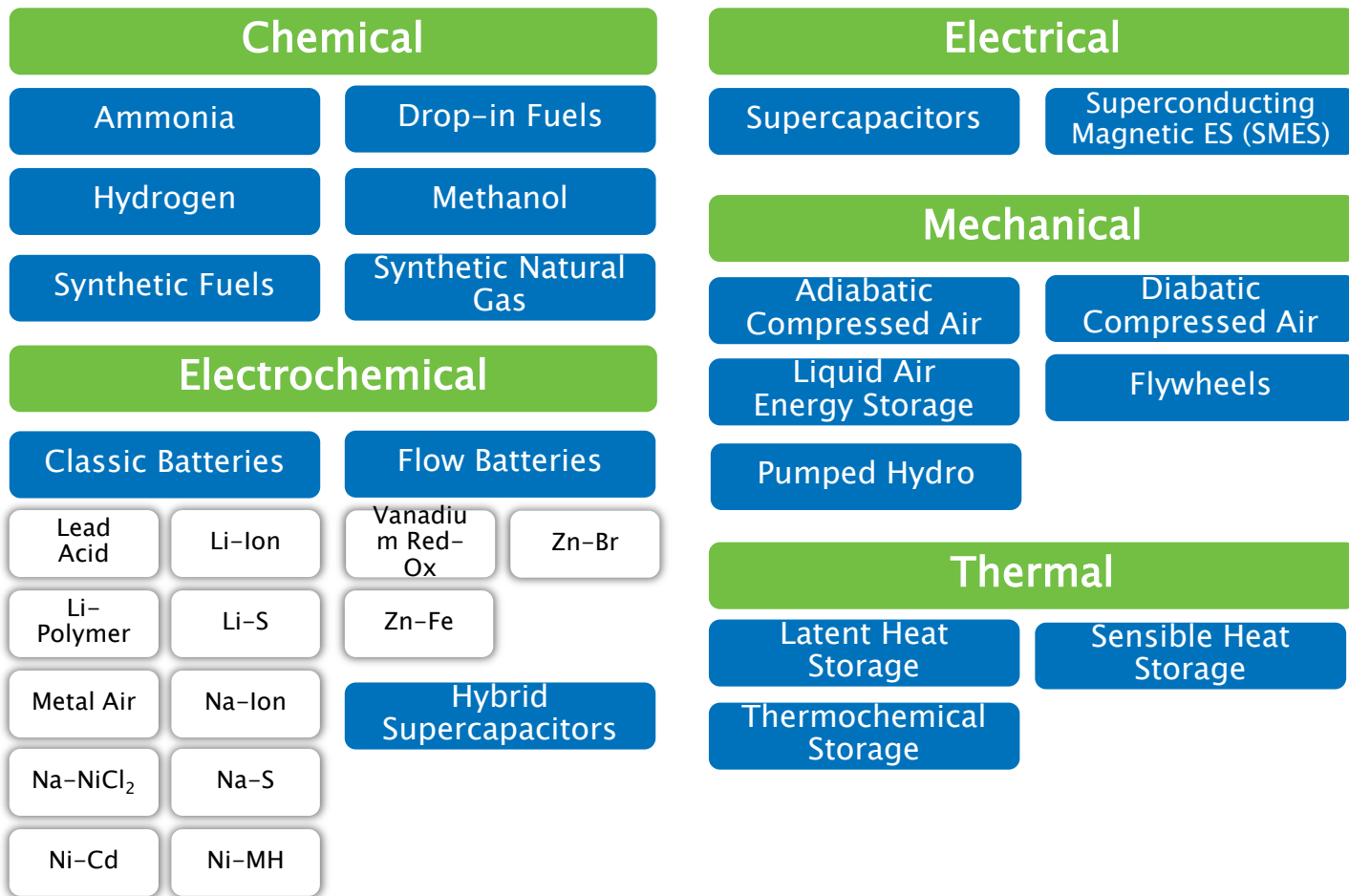





# 3. Technologies and Applications

Energy Storage can provide many valuable services across the energy system.

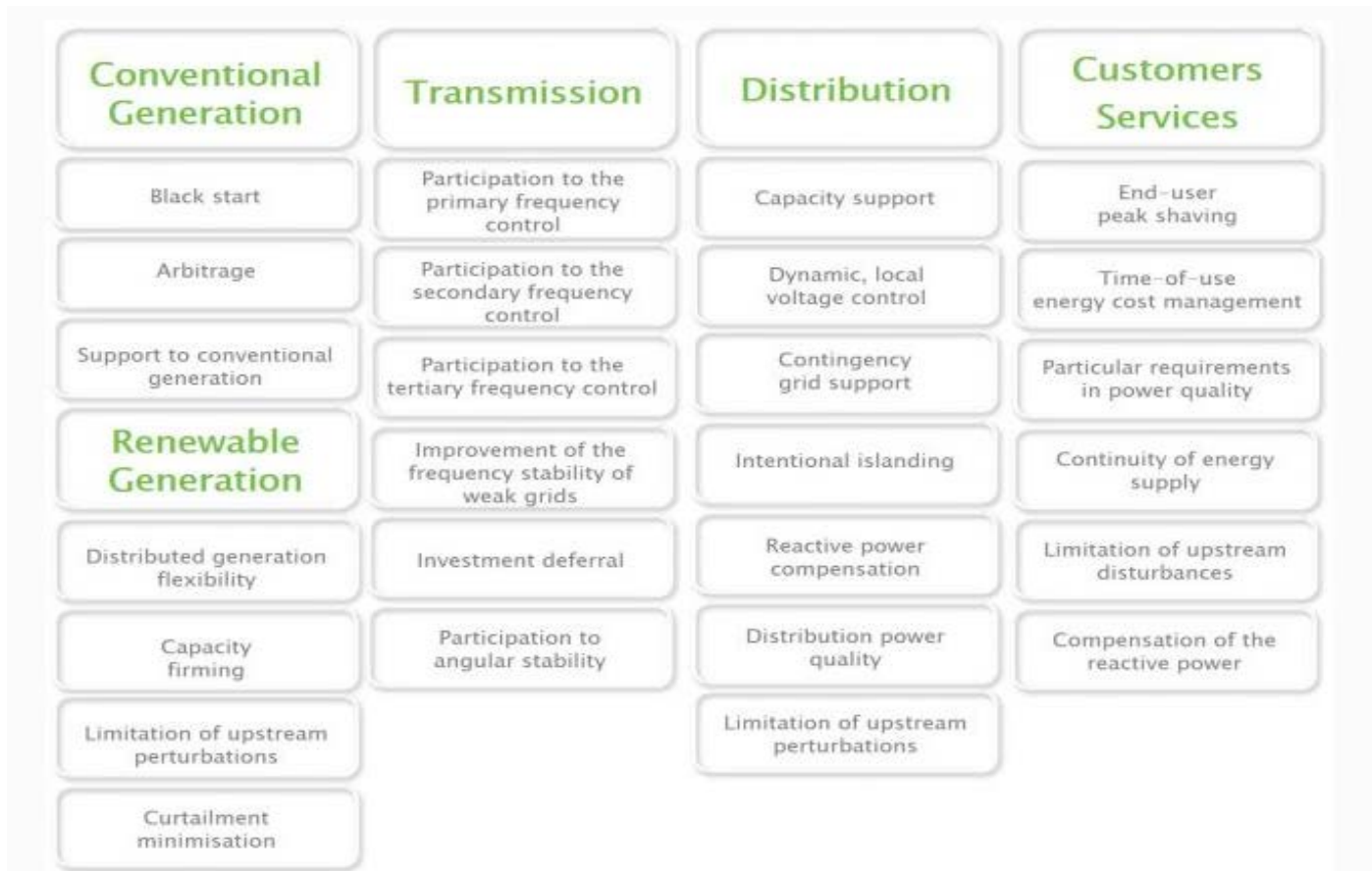



# 3. Technologies and Applications

## Short-term energy storage applications

Today, there are many short-term (second-minutes) energy storage applications for reserve services and frequency regulation:

- **Enhanced frequency response (UK):** providing frequency response in one second or less
  - **Frequency containment reserve (EU):** increasing/decreasing power output at very short notice, within 0 to 30 seconds
  - **Synthetic inertia:** inertia-like response via super fast active (milliseconds) power injection and import → This is increasingly being considered across Europe
- Many of these shorter-term services are tendered on the market.
- More needs to be done to clarify possibilities to stack multiple services on one device, allow for long-term contracts, clarify TSO/DSO ownership for provision of infrastructure services.



Seconds and Minutes



# 3. Technologies and Applications:

## Network reinforcement deferral: peak demand growth triggers power network reinforcements

- Option 1: Traditional network reinforcement (overhead or underground power lines)
- Option 2: Energy storage can be used to provide security of supply when required while providing additional services to the TSO at other times

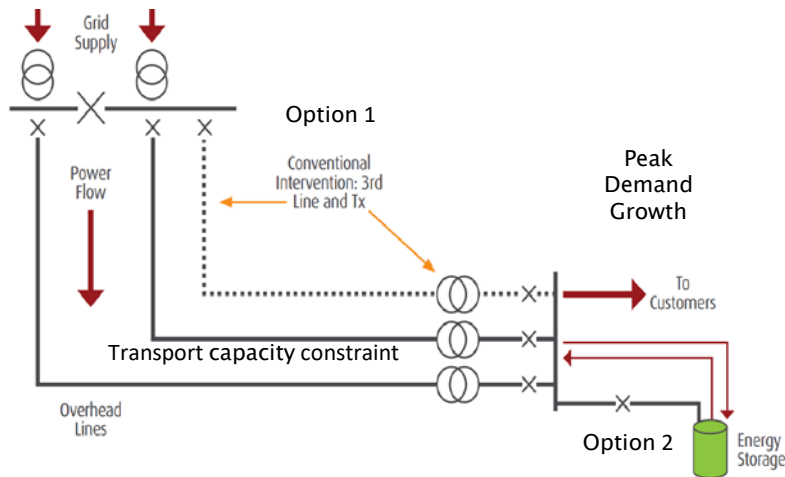

Energy capacity allocated to serve peak load at the Leighton Buzzard ESS

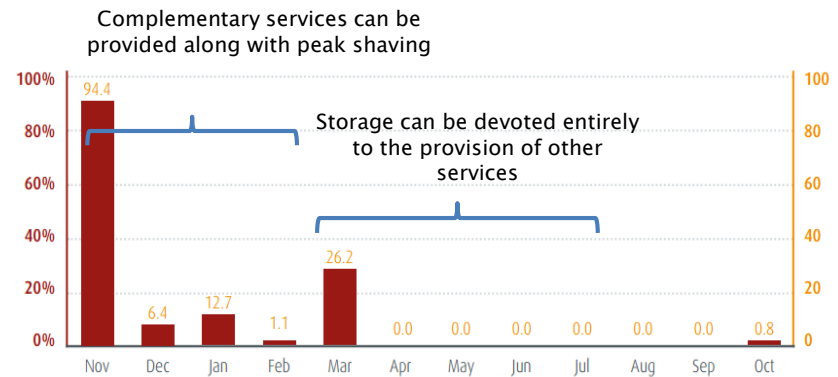

Source : UKPN, 2016. Successful Demonstrations of Storage Value Streams

### Possible Technologies:

- Mechanical: Compressed Air Energy Storage, Liquid Air Energy Storage
- Electrochemical: Lead Acid, Li-Ion, NaS, Flow batteries



# 3. Technologies and Applications

## Balancing

### Possible Technologies:

- Mechanical: Compressed Air Energy Storage (CAES), Liquid Air Energy Storage (LAES), Pumped Hydro Storage
- Electrochemical: e.g. Lead Acid, Li-ion, NaS, Flow batteries (e.g. Vanadium, Zinc-Bromine)

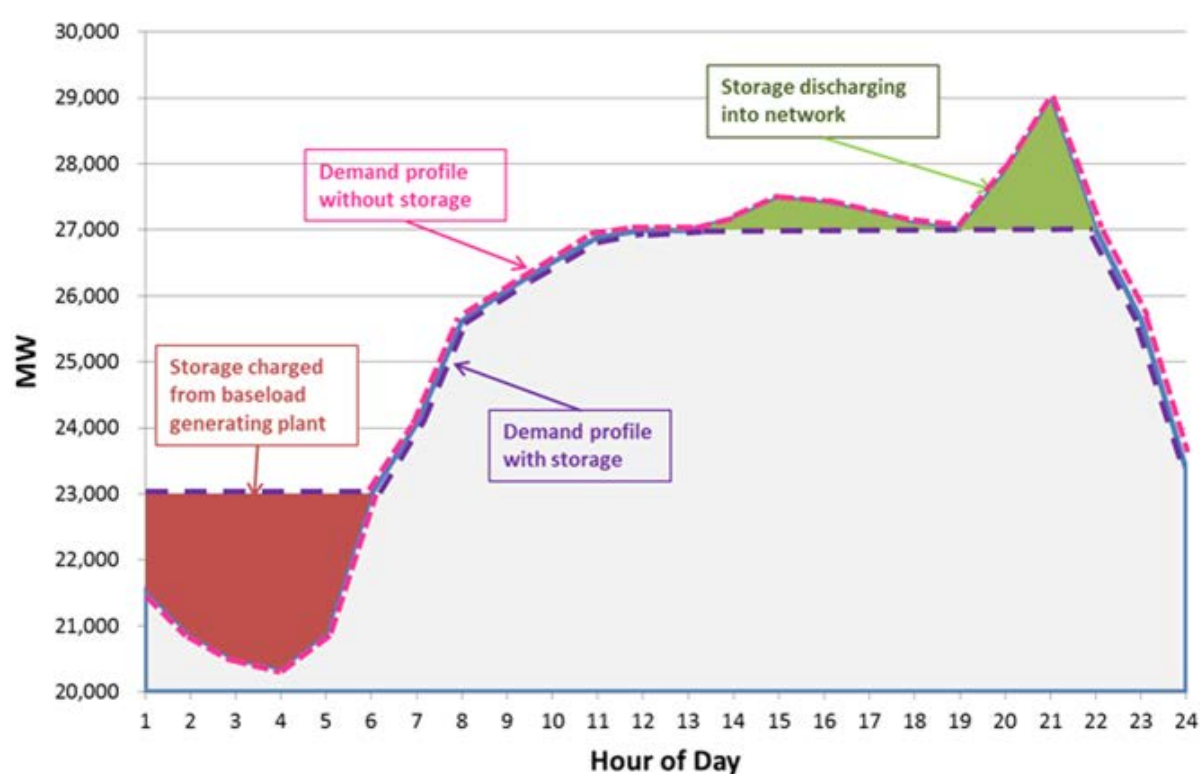

Source : <http://energyclub.stanford.edu/wp-content/uploads/2013/06/kavousian-3.png>



## 4. EU Energy Storage Policy

### Importance of Revenue Stacking

#### Applications and revenues

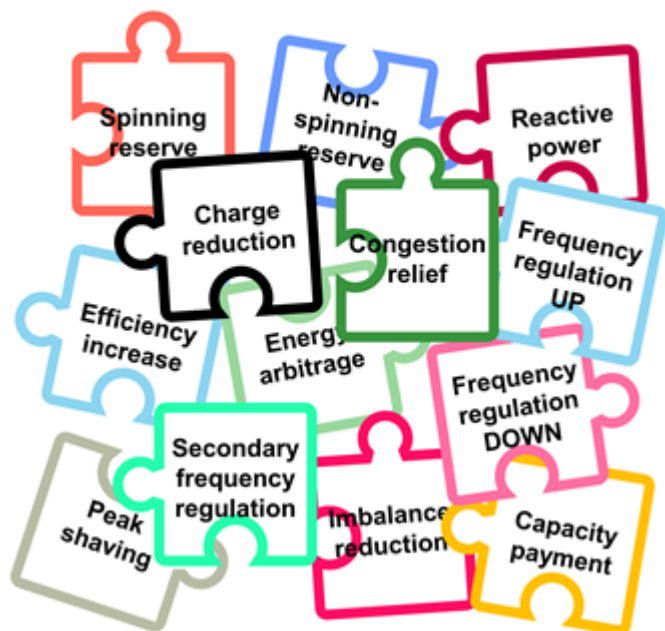

#### Applications by ESS in California

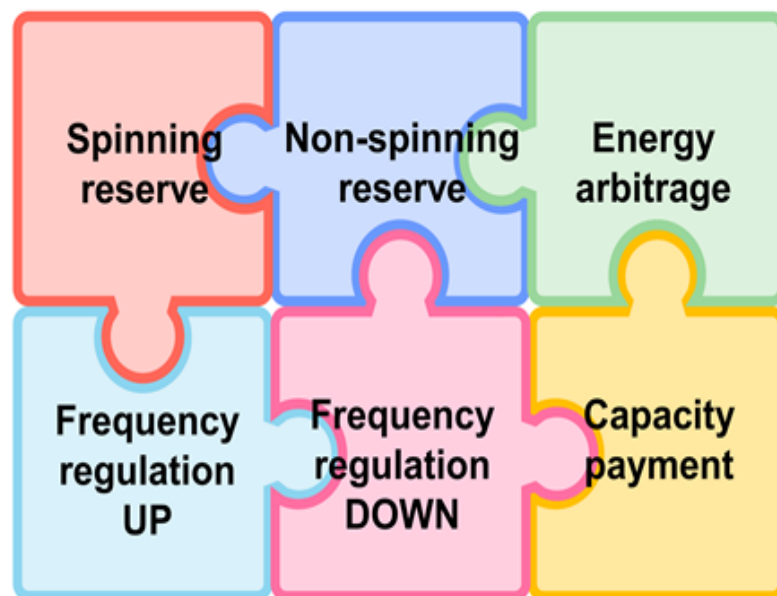

Source: ENEL - EASE Investor Workshop 2017

- Energy storage technologies have multiple applications and can derive revenue from multiple stacked revenue streams.
- To implement multi-service business cases, it is paramount to allow storage to provide all services it can deliver and to allow revenue stacking



## 4. EU Energy Storage Policy

### Example: use of a Li-Ion ESS in Ireland 1 / 3

- **Li-Ion Energy Storage System (ESS):**
  - Energy: 55 MWh or 5\*11 MWh
  - Power: 100 MW or 5\*20 MW
- **Services provided by ESS:**
  - Ancillary services: operating reserves (POR, SOR & TOR)
  - Capacity services
- **4 scenarios were considered to calculate the total cost of such ESS :**

Scenario A	Scenario B	Scenario C	Scenario D
Historical Reference Price	High End of the Current Price Range	Low End of the Current Price Range	Indicator of Near Future Price
€2.0 Million/MWh	€1.5 Million/MWh	€1.0 Million/MWh	€0.75 Million/MWh

Source: Financial Viability of Lithium-Ion Based Energy Storage Systems for Ancillary Services in the Secondary Market, Jason Omer, 2015

POR: Primary Operating Reserve  
 SOR: Secondary Operating Reserve  
 TOR: Tertiary Operating Reserve



## 4. EU Energy Storage Policy

### Example: use of a Li-Ion ESS in Ireland 2/3

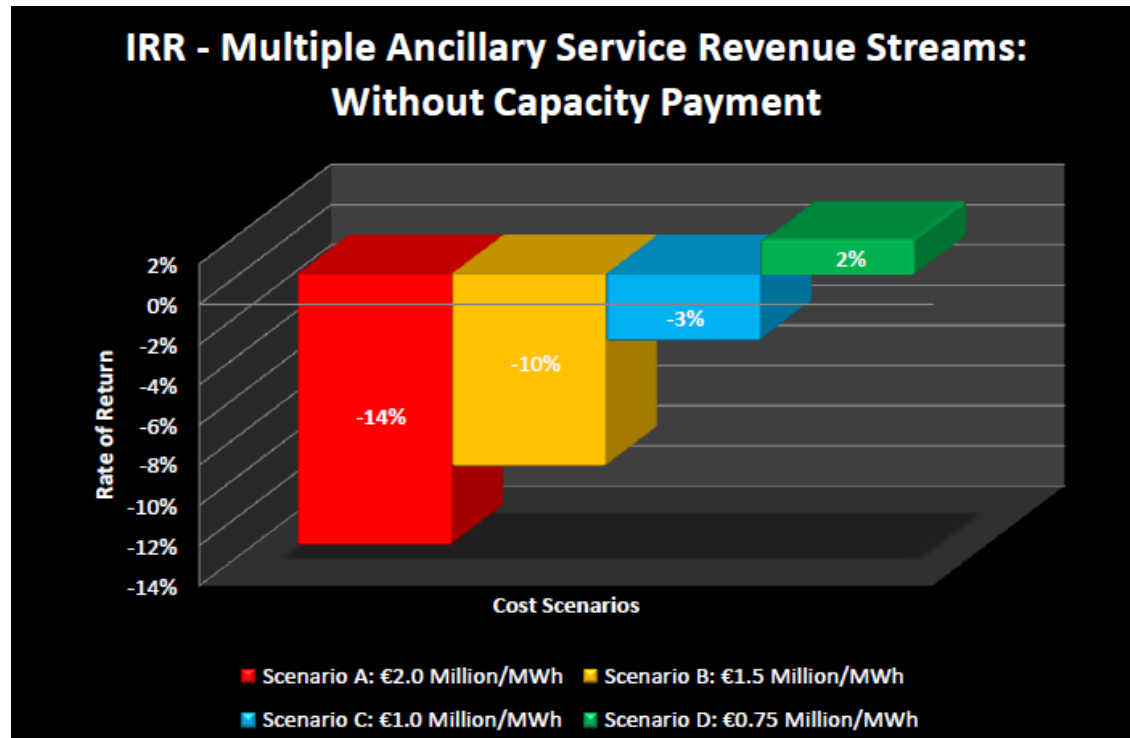

- Profitability analysis for the ESS providing a single service to the market.

Source: Financial Viability of Lithium-Ion Based Energy Storage Systems for Ancillary Services in the Secondary Market, Jason Omer, 2015



# 4. EU Energy Storage Policy

## Example: use of a Li-Ion ESS in Ireland 3/3

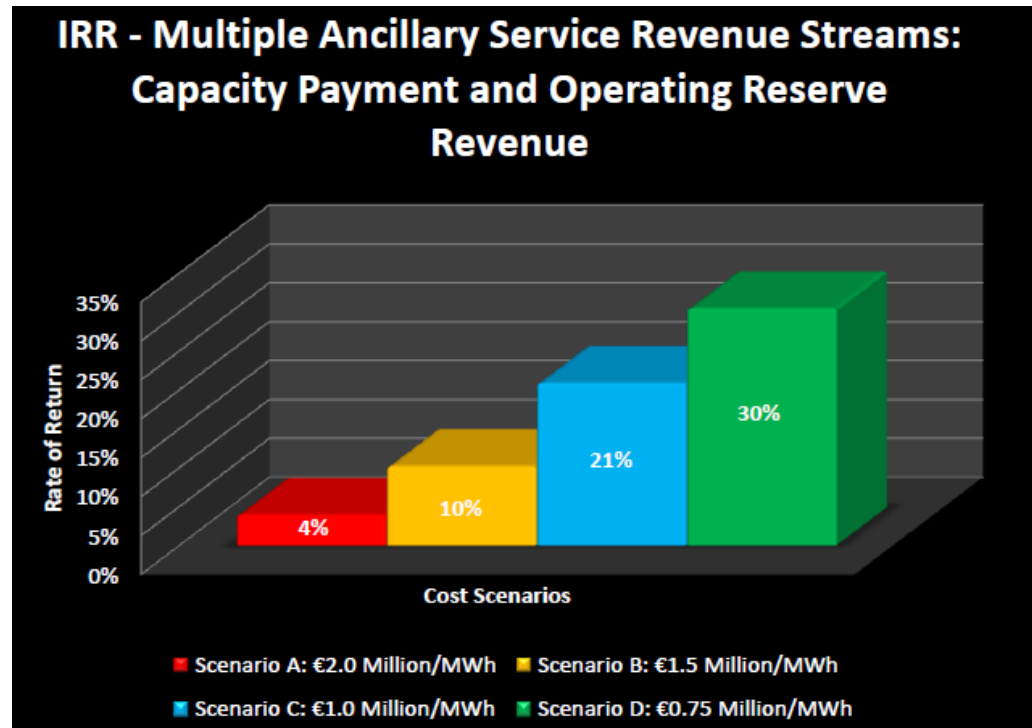

- Profitability analysis for the ESS providing several services to the market
- Revenue stacking is crucial for the profitability of storage projects

Source: Financial Viability of Lithium-Ion Based Energy Storage Systems for Ancillary Services in the Secondary Market, Jason Omer, 2015





## 4. EU Energy Storage Policy

### Multi-Service Business Cases

- The EU institutions are currently clarifying the framework under which regulated entities could own, develop, manage and operate energy storage facilities (Articles 36 and 54 of the recast Electricity Directive):
  - Council: derogation for energy storage facilities “which are fully integrated network components”
  - Parliament: exception for the operation of energy storage facilities for “local short-term control of the distribution system”
- It appears that regulated entities will be allowed to own, manage and operate storage facilities in specific, non-market cases
- Therefore it is crucial to explore different ways to maximise the value of the storage facility when a regulated entity will have been allowed to build it, e.g. by looking into multi-service business cases

Multi-service business cases see a regulated entity share operation and/or ownership of one energy storage device with a non-regulated entity



# 4. EU Energy Storage Policy

## Example: Grid Fees for Energy Storage Systems

Indicative grid charges for a fictive large-scale PHS plant

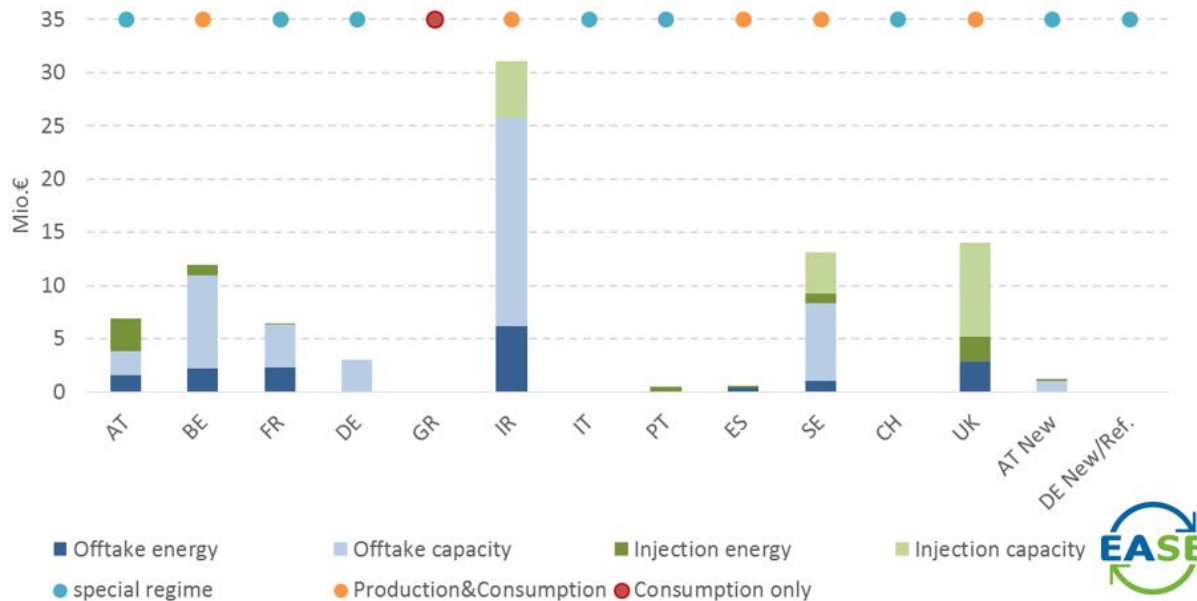

- Significant variance between countries creates distortions in cross-border energy trade: investment in PHS plants not only depends on where they are most needed, but also where grid costs are lower.
- EASE calls for a joint EU approach to grid charges, taking into account the contributions of energy storage to grid stability.

Source: EASE Position on Energy Storage Deployment Hampered by Grid Charges, 2017  
PHS: Pumped Hydro Storage



# CONTACT DETAILS

## EASE – European Association for Storage of Energy

Avenue Adolphe Lacomblé 59/8

BE – 1030 Brussels

Tel: +32 2 743 29 82 | Fax: +32 2 743 29 90

[@EASE\\_ES](https://twitter.com/EASE_ES)

[info@ease-storage.eu](mailto:info@ease-storage.eu)

[www.ease-storage.eu](http://www.ease-storage.eu)



**Secretary General:** Patrick Clerens  
**Senior Policy Officer:** Brittney Elzareï  
**Policy Officer:** Marine Delhommeau  
**Communications Officer:** Doriana Forleo  
**Project Officer:** Emin Aliyev  
**Technical Advisor:** Jean-Michel Durand



# EASE Members

