

Innovative business models and complementarities with renewable offshore technologies

IRENA Workshop - October 15th, 2019

Alexandre Paris

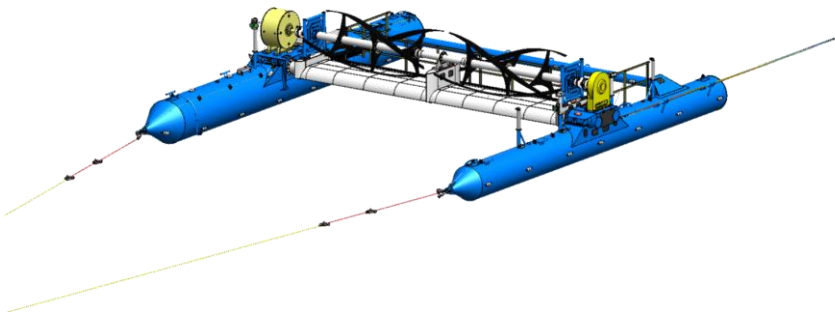

ORPC

Marine Renewable Energy (MRE)



Who we are

- Created in 2004
- 30+ employees in 3 countries (USA, Canada & Ireland)

What we do

- Convert kinetic energy in moving water into clean, predictable, affordable sources of renewable electricity
- Completely underwater, do not interfere with navigation and are not visible
- “No known adverse impact on the marine environment”

How we do it

- Close relationship with the communities
- Process and solutions that respect the environment
- Flexible business model



14 years of continuous innovation (and evolution of our business model)



TGU deployed onto bottom support frame, installed using a barge mounted crane

2012



Buoyant tension mooring system tested

2014



RivGen® 2.0 production unit, Igiugig Project

2019

2010

TGU deployed using deployment arms from a barge



2013

Catamaran retrieval of TGU reduced cost by 2/3



2015

RivGen® self-deployed, connected to Igiugig grid



Alternative markets



**Community Scale
Power: RivGen®**

Project: Igiugig,
Alaska

**Grid Integration
Smartgrid
Architecture
Energy Storage**

Projects: Igiugig Phase 2
& False Pass, Alaska

**Remote Power and
Propulsion:
Autonomous TGU**

Project: ARPA-E

**Utility Scale
Power: TidGen®**

Project: Western
Passage, Maine



SCALE

DIVERSIFY

Autonomous TGU



- Subsea power supply and propulsion module
 - Defense, scientific and commercial markets
- Utilizes multiple functionalities for long distance, high endurance missions
 - Unmanned underwater vehicle (UUV) charging
 - Subsea sensor network support,
 - Heavy-lift and marine construction applications

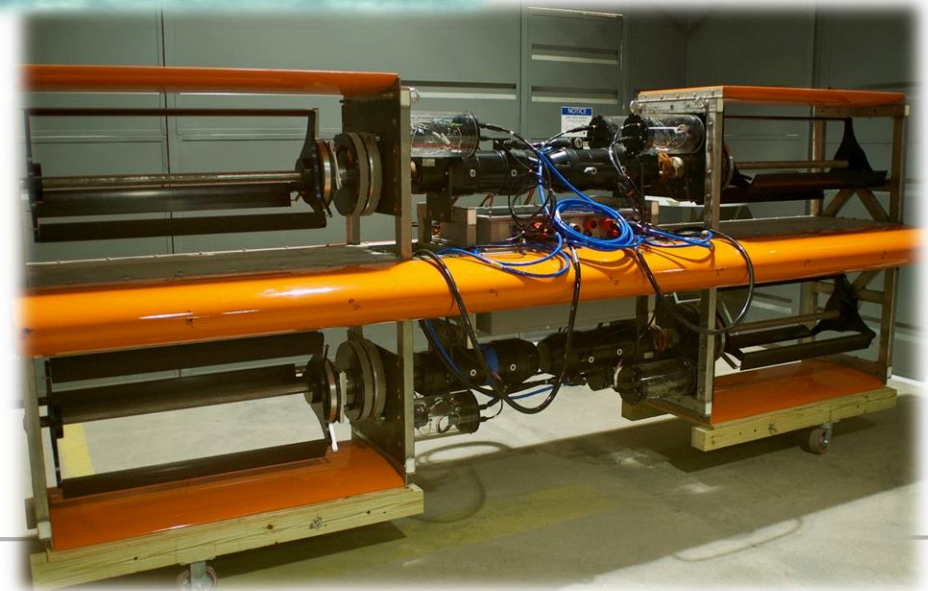
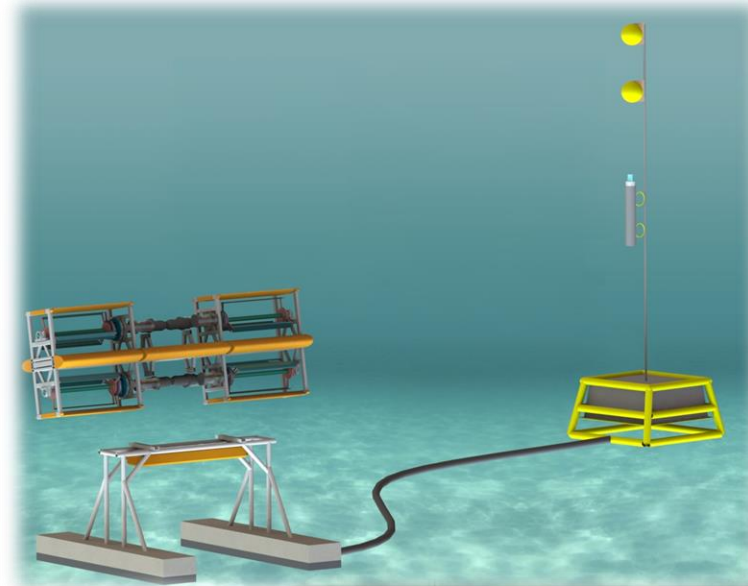

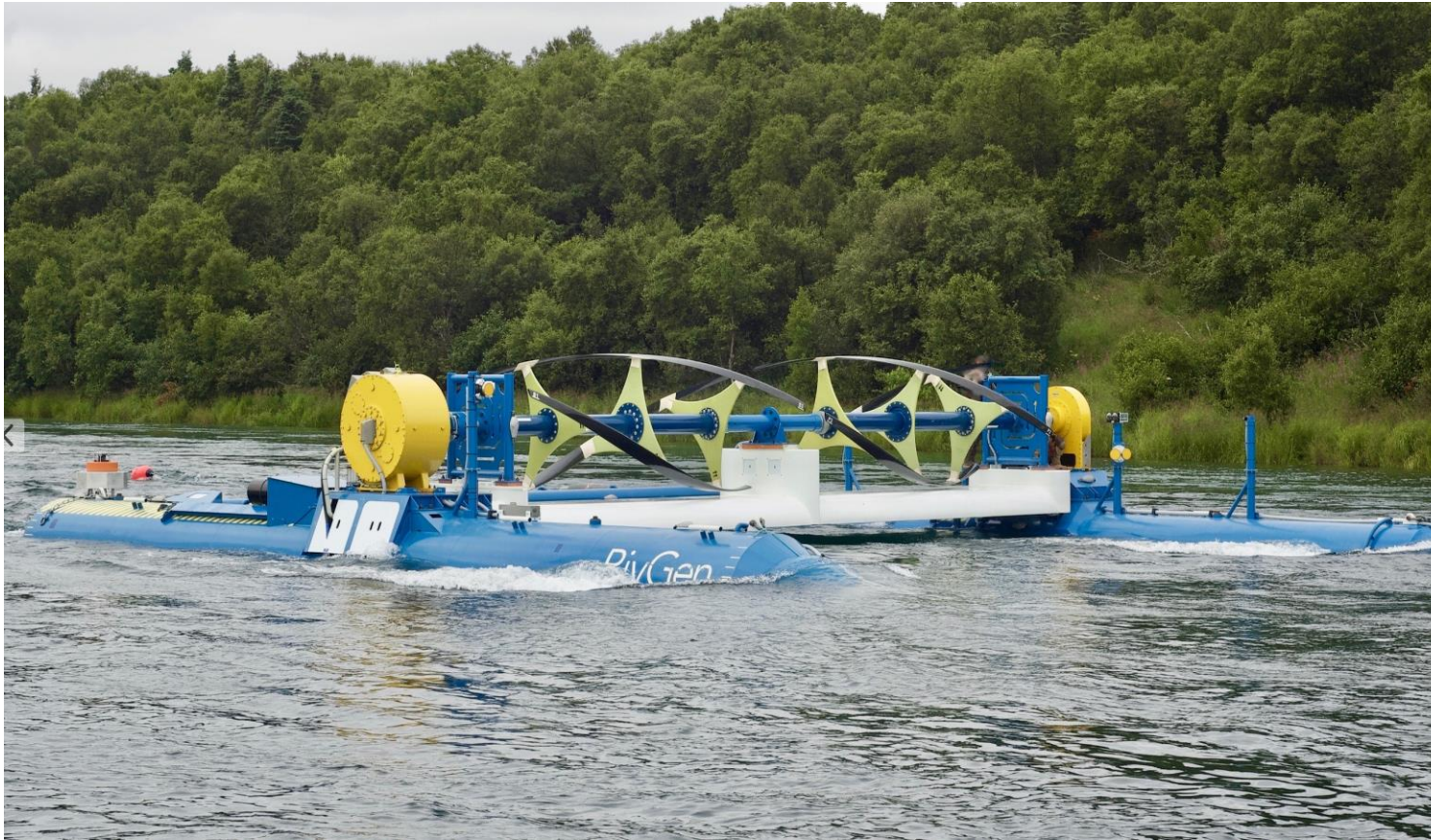

RivGen® Power System

Remote community river

Power

- 40kW rated (at 2.25 m/s)
- 80kW rated (at 3.5 m/s)
- Operational up to 3.5 m/s

Logistics

- Transportable in standard Shipping containers
- Modular onsite assembly
- Towable, self-deploying system

Physical

- 5 m - 10 m water depths
- 15.7 m(l) x 3.5 m(h) x 14.4 m(w)
- 29,500 kg (dry weight)

Business challenges and opportunities



- Challenges:
 - Understanding clients' needs, capabilities, and energy objectives
 - Financing capital intensive projects
 - Work in a complex of regional ecosystem
- Opportunities:
 - Offer turnkey microgrid system where MRE provides the baseload
 - Establish new partnerships to deliver complete energy solutions



Microgrid baseload system - Igiugig



- Diesel usage down 90%
- CO2 down 230 metric tons/year
- Diesel cost down \$170,000/year
- O&M costs down \$50,000/year
- Noise eliminated and environmental risk decreased

Lease and services agreement provided at level of community affordability

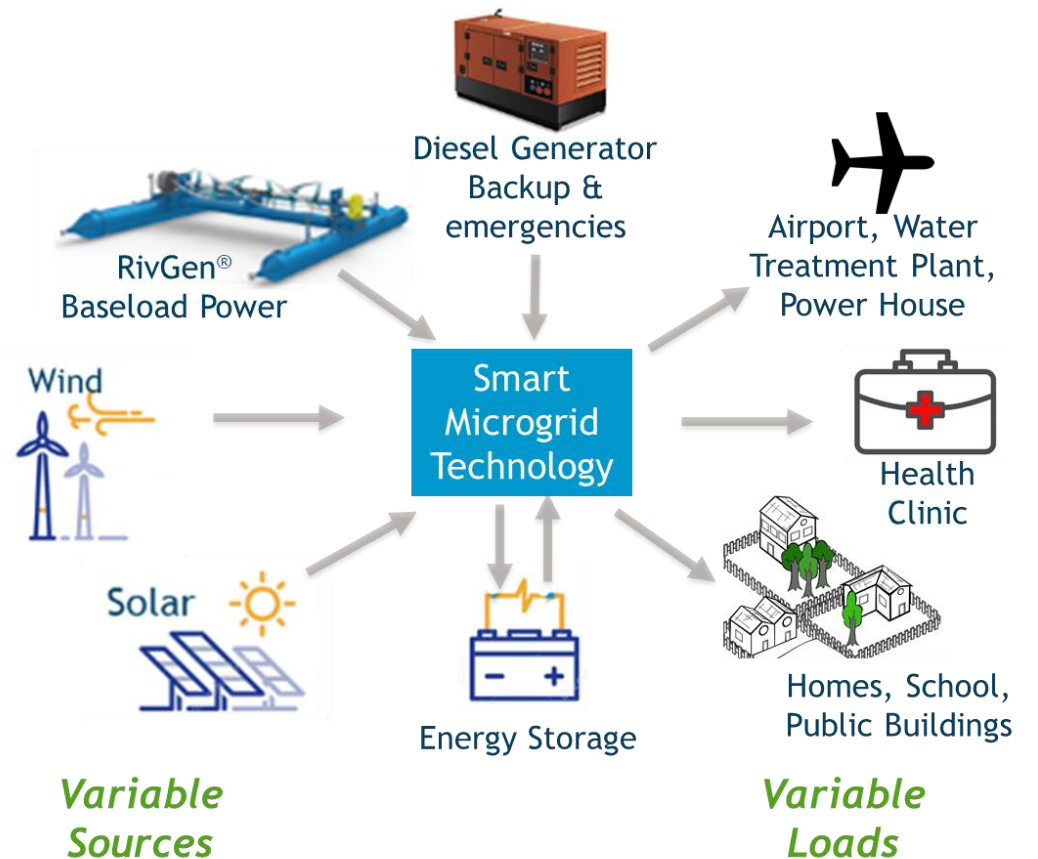

Business models



- Models:
 - Sales
 - Lease (EaaS)
- Decision factors:
 - Energy demand
 - Operational needs and capabilities
 - Long and short-term goals

Zero Carbon Smart Microgrid Solution

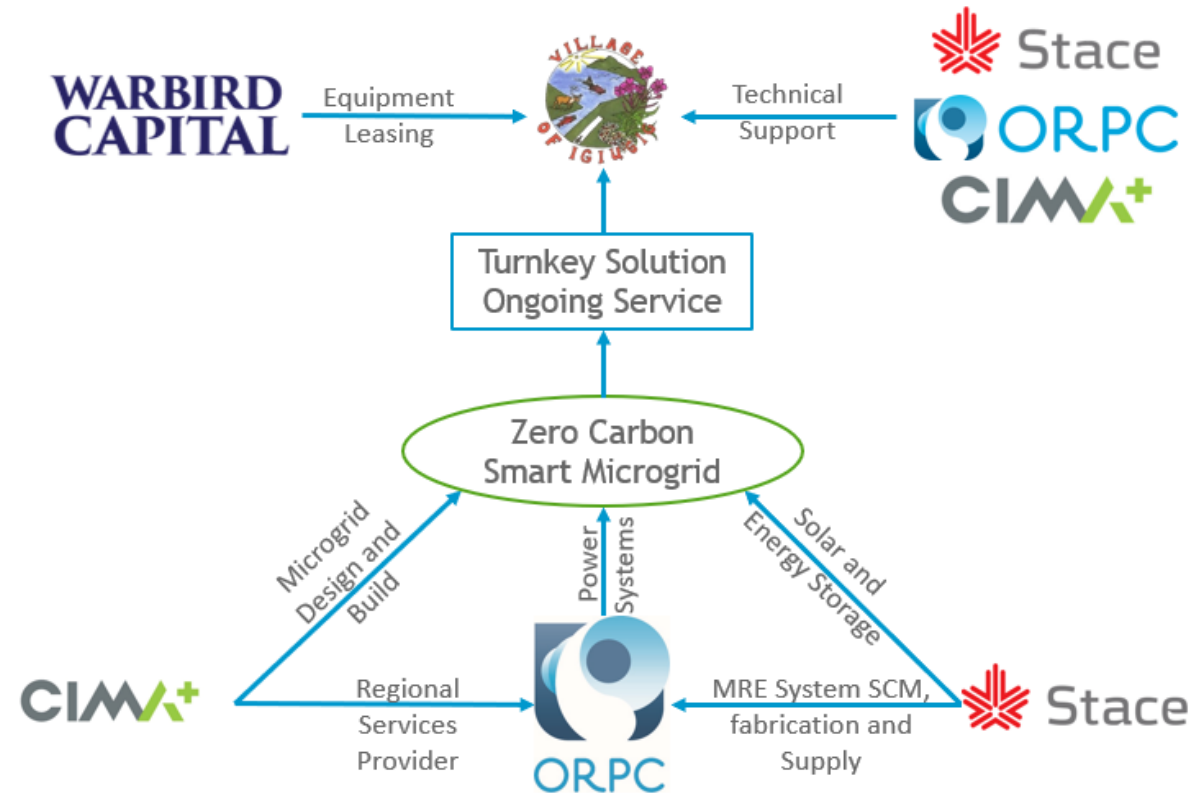

Remote community can buy or lease zero carbon smart microgrid solution

Energy as a Service

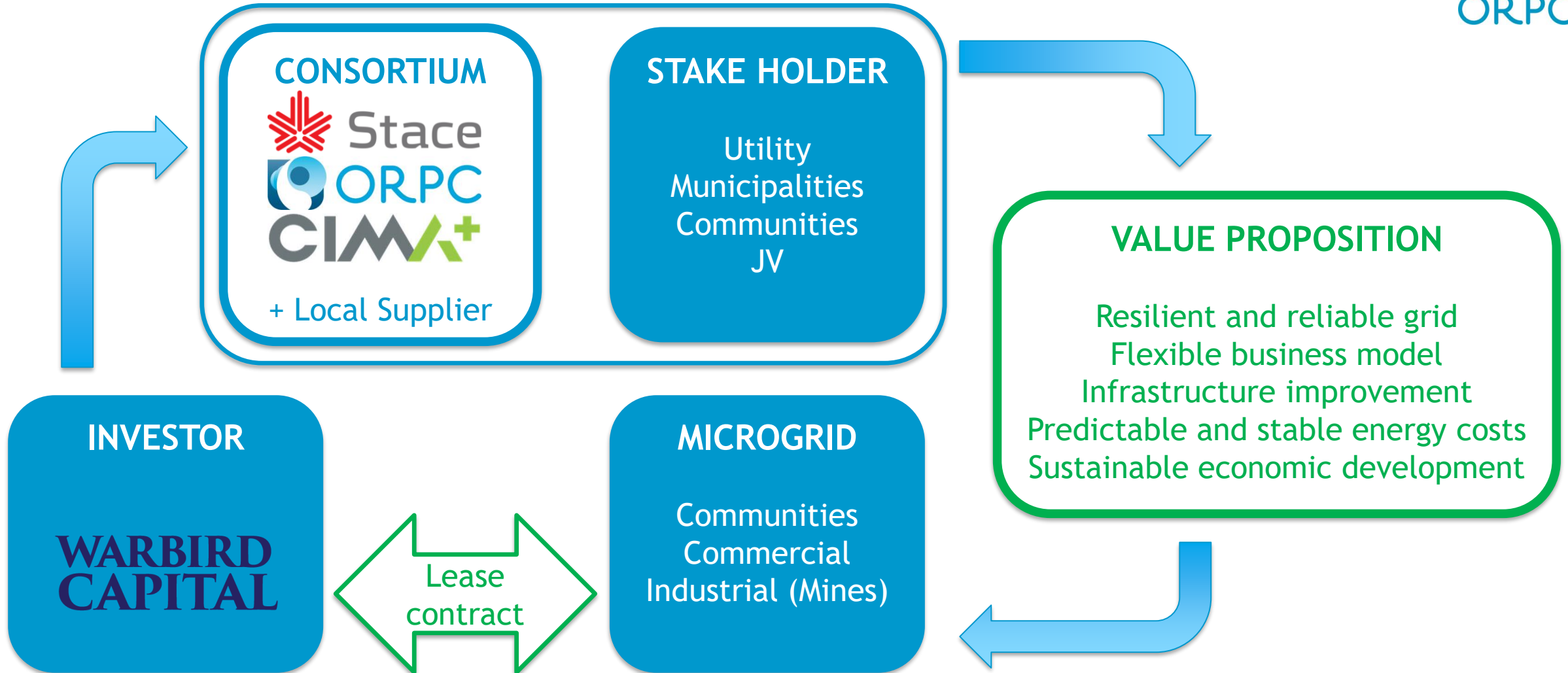

“A transition picture”



Fuel plane flying over the RivGen[®] being assembled in Igiugig

Photo taken by AlexAnna Salmon, President IVC, on June 19, 2019



*Thank You
Merci*

Alexandre Paris
(aparis@orpc-canada.ca)