

RENEWABLE DESALINATION: TECHNOLOGY OPTIONS FOR ISLANDS 2015

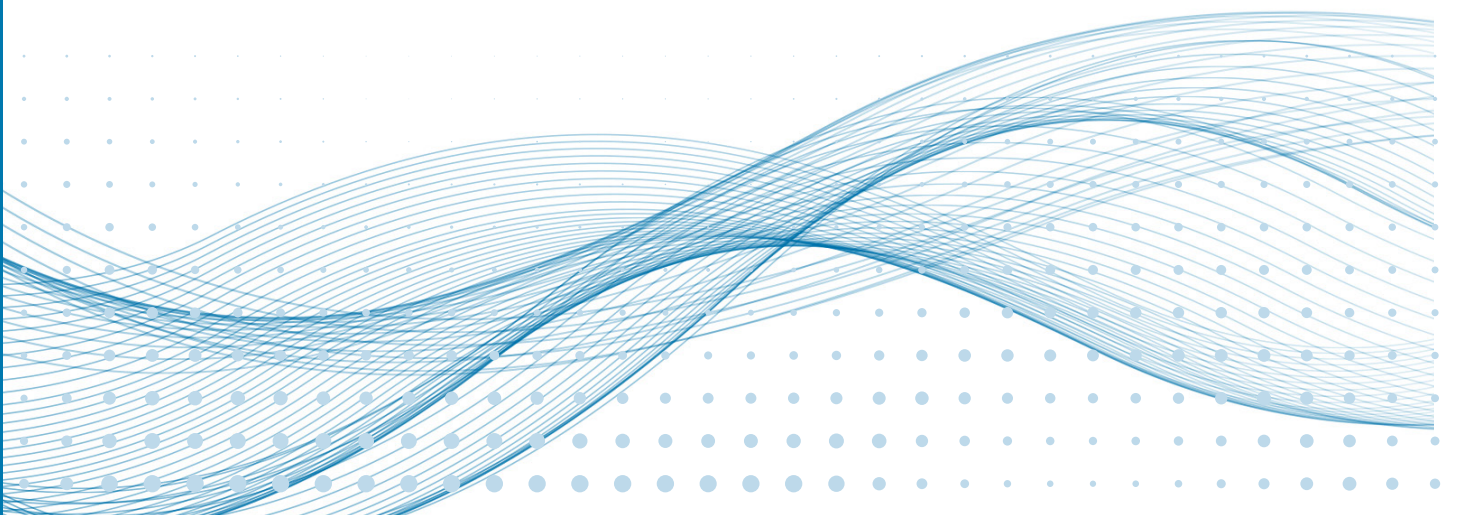

Copyright © IRENA 2015

Unless otherwise stated, this publication and material featured herein are the property of the International Renewable Energy Agency (IRENA) and are subject to copyright by IRENA.

Material in this publication may be freely used, shared, copied, reproduced, printed and/or stored, provided that all such material is clearly attributed to IRENA and bears a notation that it is subject to copyright (© IRENA 2015).

Material contained in this publication attributed to third parties may be subject to third party copyright and separate terms of use and restrictions, including restrictions in relation to any commercial use.

About IRENA

The International Renewable Energy Agency (IRENA) is an intergovernmental organisation that supports countries in their transition to a sustainable energy future, and serves as the principal platform for international co-operation, a centre of excellence, and a repository of policy, technology, resource and financial knowledge on renewable energy. IRENA promotes the widespread adoption and sustainable use of all forms of renewable energy, including bioenergy, geothermal, hydropower, ocean, solar and wind energy, in the pursuit of sustainable development, energy access, energy security and low-carbon economic growth and prosperity.

www.irena.org

About Fraunhofer Institute for Solar Energy Systems ISE

The Fraunhofer Institute for Solar Energy Systems ISE conducts research on the technology needed to supply energy efficiently and on an environmentally sound basis in industrialised, threshold and developing countries. To this purpose, the Institute develops systems, components, materials and processes in the areas of the thermal use of solar energy, solar building, solar cells, electrical power supplies, chemical energy conversion, energy storage and the rational use of energy.

The Institute's work ranges from fundamental scientific research relating to solar energy applications, through the development of production technology and prototypes, to the construction of demonstration systems. The Institute plans, advises and provides know-how and technical facilities as services.

Acknowledgements

The following reviewers provided valuable insights and criticisms to improve the content: Amit Jain, Asia Development Bank; Dan Olis, National Renewable Energy Laboratory; Terri Walters, and Katevan Consulting; and Jeffrey Skeer of IRENA. All errors and omissions are the responsibility of the authors.

For further information or to provide feedback, please contact: Jeffrey Skeer, IRENA; JSkeer@irena.org or publications@irena.org

Authors: Joachim Koschikowski, Verena Jülch, Thomas Kec, Noha Saad Hussein (Fraunhofer Institute for Solar Energy Systems ISE, Freiburg, Germany)

Reviewers: Jeff Skeer, Angeline Heine (Energy Planner, Marshall Islands), Walter Myazoe (Energy Officer, Marshall Islands), Benjamin Jesse (Director of Energy, Vanuatu), Arieta Gonelevu Rakai

Disclaimer

This publication and the material featured herein are provided "as is", for informational purposes.

All reasonable precautions have been taken by IRENA to verify the reliability of the material featured in this publication. Neither IRENA nor any of its officials, agents, data or other third-party content providers or licensors provides any warranty, including as to the accuracy, completeness, or fitness for a particular purpose or use of such material, or regarding the non-infringement of third-party rights, and they accept no responsibility or liability with regard to the use of this publication and the material featured therein.

The information contained herein does not necessarily represent the views of the Members of IRENA, nor is it an endorsement of any project, product or service provider. The designations employed and the presentation of material herein do not imply the expression of any opinion on the part of IRENA concerning the legal status of any region, country, territory, city or area or of its authorities, or concerning the delimitation of frontiers or boundaries.

Renewable Desalination: Technology Options for Islands

Table of Contents

LIST OF FIGURES.....	IV
LIST OF TABLES.....	V
ABBREVIATIONS.....	VI
Executive Summary.....	VII
1 Introduction.....	1
2 Assessment of Island Markets for Renewable Energy Desalination Technology.....	2
2.1 General Boundary Conditions on Potential Islands.....	2
2.2 Desalination Demand and Installation on Islands.....	3
2.3 Desalination Technologies and Capacities – Island Case Studies.....	5
2.4 Cost of Electricity.....	7
2.5 Cost of Water.....	10
3 Description and Evaluation of Desalination Technologies for Island Applications.....	14
3.1 Thermally Driven Desalination Technologies.....	15
3.2 Electric Desalination Technologies.....	18
3.3 Unconventional Desalination Technologies.....	20
4 Renewable Desalination Technology Assessment.....	25
4.1 Potential Sources of Renewable Energy for Desalination.....	25
4.2 Assessment of Technically Mature Renewable Desalination.....	28
5 Economic Assessment of Renewable Desalination Options.....	34
5.1 Cost of Water from Reverse Osmosis Desalination with Photovoltaics.....	34
5.2 Reverse Osmosis Desalination with Concentrated Solar Power.....	38
5.3 Multi-effect Distillation with Concentrated Solar Power.....	39
5.4 Reverse Osmosis with Wind.....	41
5.5 Comparison of Water Costs for Different Renewable Desalination Technology Pairs.....	43
6 Barriers to island renewable desalination.....	46
6.1 Barriers and Drivers.....	46
6.2 Availability of Desalination Systems, Suppliers and Operators.....	49
6.3 Best Practice for Deploying Island Renewable Desalination.....	54
References.....	60
Annex.....	66
Annex I: LCOE method.....	66
Annex II: LWC method.....	67

LIST OF FIGURES

Figure 1: Desalination Capacity Shares by Technology world-wide and for selected SIDS	5
Figure 2: Levelised Cost of Electricity as Function of Diesel Prices and Diesel Unit Size	9
Figure 3: Levelised Water Cost for RO Plants Producing 250-2,000 m ³ /day	11
Figure 4: Levelised Water Cost of MED Plant with Electricity Prices at 0.20-0.50 USD/kWh	12
Figure 5: Levelised Water Cost of Waste-heat MED Plants at Varying Electricity Prices	12
Figure 6: Diagram of a Multi-stage Flash Desalination System	15
Figure 7: Diagram of a Multi-effect Distillation System	16
Figure 8: Diagram of a Mechanical Vapour Compression System	17
Figure 9: Diagram of a Reverse Osmosis Process Configuration	18
Figure 10: Simplified Diagram of a Single-stage Electrodialysis System	20
Figure 11: Diagram of a Simple Single Basin Solar Still for Water Desalination	20
Figure 12: Diagram of a Simple Humidification/Dehumidification System	21
Figure 13: Diagram of Simple Direct Contact Membrane Distillation Setup	22
Figure 14: Possible Combinations of Renewable Energy Sources and Desalination Technologies	26
Figure 15: Maturity Level Versus Capacity Range of Specific Renewable Energy Desalination Technologies	29
Figure 16: Levelised Cost of Water for Grid-connected PV-RO Plants Producing 250-2,000 m ³ /day at a Global Horizontal Irradiance of 2,000 kWh/m ² /year	36
Figure 17: Levelised Cost of Water for PV-RO Systems Running 7 and 24 hours/day with Annual Global Horizontal Irradiance of 2,000 kWh/m ² and WACC at 5% - 10%	38
Figure 18: Levelised Cost of Water for CSP-RO plant	39
Figure 19: Levelised Cost of Water for a CSP-MED System with 15 hours of Storage	40
Figure 20: Levelised Cost of Water for Wind-RO Plant Producing 250 m ³ /day	42
Figure 21: Levelised Cost of Water for Off-grid Wind-RO Producing 250 m ³ water/year	43
Figure 22: Levelised Cost of Water for Different Renewable Desalination Technologies on Islands	44
Figure 23: Guide to selecting a renewable desalination technology	55
Figure 24: Desalination Capacities Greater than 20,000 m ³ /day	56
Figure 25: Desalination Capacities Less than 20,000 m ³ /day	57

LIST OF TABLES

Table 1: Fresh Water Withdrawal by Use for Selected Locations	4
Table 2: Characteristics of Selected Islands and Island States	7
Table 3: Input Data for Calculating Levelised Cost of Electricity	8
Table 4: Electricity Prices and Costs on Selected Islands	9
Table 5: Input Data for Calculating Levelised Water Costs of RO Plants	10
Table 6: Input Data for Calculating Levelised Water Costs of MED Plants	10
Table 7: Water Prices on Selected Islands	13
Table 8: Advantages and Disadvantages of Renewable/Desalination Combinations	31-33
Table 9: Data to Calculate the Levelised Cost of Electricity from PV Plants	35
Table 10: Composition of the Cost of Electricity for a Reverse Osmosis Plants	35
Table 11: PV-RO Systems Data Operating 7 Hours and 24 Hours per Day	37
Table 12: Data for Calculating Levelised Cost of Electricity from CSP Plants	38
Table 13: Data for Calculating Water Costs from CSP-Driven RO Desalination Systems	39
Table 14: Data for Calculating the Levelised Cost of Heat from CSP Plants	40
Table 15: Wind Energy Data to Calculate Levelised Costs of Electricity	41
Table 16: Main Input Parameters for Levelised Water Costs for Wind-RO Systems	42
Table 17: Summary of Companies with Experience of Solar Desalination:	
a) Suppliers of PV-RO Desalination	49
b) Solar Thermal Desalination Suppliers	50
c) Major suppliers of other renewable desalination	50
Table 18: Networks and Organisations Supporting Renewable Desalination:	
a) Regional Networks	52
b) Research and Development Institutions	53
Table 19: Overview of Onstream Desalination Capacity and Total Fresh Water Withdrawal for a Range of Islands	58
Table 20: PV-RO Systems Installed with Support from the Pacific Environment Community Fund	59

ABBREVIATIONS

BOOT	Build-Own-Operate Transfer
CAPEX	Capital Expenditure
CSP	Concentrated Solar Power
ED	Electrodialysis
FO	Forward Osmosis
HDH	Humidification/dehumidification
kg	kilogram
kW	kilowatt
kWh	kilowatt-hour
kWp	kilowatt-peak
LCOE	Levelised cost of electricity
LWC	Levelised cost of water
m ³	cubic metre
MD	Membrane Distillation
MED	Multi-effect distillation
MSF	Multi-stage flash
MVC	Mechanical vapour compression
MW	Megawatt
MWh	Megawatt-hour
O&M	Operations and Maintenance
OPEX	Operating Expenditure
OTEC	Ocean Thermal Energy Conversion
PV	Photovoltaic
R&D	Research and Development
RO	Reverse Osmosis
SIDS	Small Island Developing States
SWRO	Sea Water Reverse Osmosis
TVC	Thermal Vapour Compression
WACC	Weighted Average Cost of Capital

Executive Summary

This study reviews renewable desalination technologies close to market entry with the technological and economic potential to contribute significantly to water supply infrastructure on islands. It finds that renewable desalination can be cost-competitive with fossil-fuel desalination on islands facing high import costs. The cost of water on islands can be reduced by running desalination systems based on reverse osmosis (RO) or multi-effect distillation (MED) with electricity from photovoltaic (PV) or concentrated solar power (CSP). RO systems can also be run on power produced from wind. Renewable power options can also reduce the costs of desalination by cutting island grid fossil fuel requirements.

Several criteria have to be considered to select the appropriate renewable energy for island desalination technologies. The size of the island can be an initial indicator of the required desalination capacity, but the dimension and type of settlement, and related infrastructure is more important. A small island with centralised urbanisation may need a few medium-scale desalination plants, which can be part of a centralised energy and water supply grid. Islands with small distributed settlements and poor infrastructure require small-scale stand-alone desalination systems. Large islands with high population density generally have more centralised energy grids and water supplies. Here, the renewable energy power supply for desalination would be large-scale, dislocated and grid-connected and are not the subject of this study. Also, the condition and salinity of raw water should be assessed to see if desalination is needed. If so, the quality of wind and solar resources should be evaluated to decide whether it is cost-effective to use renewables for desalination.

Technology-readiness and scalability are important criteria when evaluating renewable desalination on islands. This report assesses the readiness of different technologies using literature reviews and the authors' experience in renewable desalination. It highlights technologies that work well at a small scale and are considered appropriate for islands; small-scale renewable desalination plants are defined as 10-100 cubic metres per day (m^3/day), while medium-scale plants are defined as up to 1,000 m^3/day . Using these criteria, MED is the most promising thermally powered desalination technology that can be coupled with CSP systems. RO is the most promising electrically powered technology that can be coupled with PV or wind power.

In comparing the levelised cost of water (LWC) for renewable and fossil-fuel desalination plants with, for example, a target capacity of 250 m^3/day , it has been noted that the fuel costs of a fossil-fuel plant has a strong effect on water costs. If the waste heat is free of charge in a fossil-fuelled MED desalination plant, the cost of water can start at one US Dollar per cubic metre (1 USD/ m^3). If the MED process is powered from a fossil-fuel heat plant that does not produce electricity, and fuel costs are entirely assigned to desalination, the water cost is greater with a range between 4.8-9.2 USD/ m^3 . If the costs of a fossil-fuelled power plant were allocated between electricity generation and heat on an energy basis, the MED cost would fall somewhere between these two extremes. Desalination from a fossil-fuelled RO plant costs around 1.6-3.3 USD/ m^3 of fresh water produced.

Therefore, renewable desalination can be cost-competitive with fossil-fuel desalination on islands, depending on the resources in that location and the cost of the fossil fuel. The water cost can be reduced in RO and MED systems run by PV and CSP, as well as in RO systems driven by wind (see

section 5.5). Where grids are available, installing renewable energy systems to reduce the amount of fossil fuel required for desalination may also be economically attractive. This could be the short-term solution for medium and large-scale desalination plants driven by renewables.

For islands with a more centralised energy supply, desalination systems powered by electricity could also act as a 'flexible load' in a grid dominated by renewable energy in future. Research and development (R&D) efforts are therefore required to adapt RO technology to transient operation conditions. This adaptation is also the key to significantly reducing the cost of small-scale stand-alone systems, because it averts the deployment of expensive batteries. This is already reflected by the significantly lower cost of a PV-RO 7-hour operation off-grid solution with a very small battery, compared to a PV-RO 24-hour operation off-grid solution with large battery capacity.

Renewable desalination systems face several technology challenges. Research fields include membrane development, along with membrane preparation and treatment. In locations with high water salinity, requirements for operations and maintenance (O&M) are greater. Capacity building is therefore essential. Technical service networks must be established for proper installation and maintenance, including business models that can attract investors. A number of companies are ready to adapt and install pilot systems on islands. Several R&D institutions and capacity-building organisations are also working to make a successful market introduction of renewable desalination systems.

To select renewable desalination systems for any one particular island, more detailed analysis is recommended. The meteorological and hydrological circumstances and available grid infrastructure need to be evaluated, together with the political, legislative and administrative conditions. Once information on the local cost of energy has been obtained, the cost of water from renewable desalination options should be compared to that from fossil-fuel desalination, to determine the most cost-effective options for renewable desalination. Environmental and public acceptance considerations should also be taken into account to choose the most practical renewable desalination system for the island. An overall water resource management plan for an island must also carefully consider other potential sources of water, such as wastewater reuse and storm water harvesting and treatment.

1 Introduction

Many islands today face a critical shortage of fresh water for local inhabitants and tourists. If expensive fresh water imports are to be avoided, islands must increasingly rely on desalination systems, typically run on imported fossil fuels that are costly. This creates a market opening for renewable energy technologies to desalinate water, so long as desalination carries an acceptable cost and local capacities are in place to install and operate the systems.

This study aims to provide an overview of renewable energy desalination options and an estimation of their cost-saving potential compared to fossil-fuel systems. A few islands are first movers on desalination, such as the Canary archipelago, which has a total installed capacity of more than 600,000 m³/day. However, this study focuses mainly on small island developing states (SIDS), who are adversely affected by climate change and need new technologies. This study accounts for different meteorological, hydrological and climate conditions, as well as different economic structures, through a broad overview of various technology options and examples where necessary. Local conditions need to be assessed in detail to provide a clear picture of the right technology choice and corresponding cost.

Chapter 2 reviews the general conditions for island renewable energy driven desalination, considering conditions such as water resources, existing desalination capacities and electricity and water costs. Chapter 3 presents technology options for island applications, covering renewable energy technologies as well as desalination technologies. Chapter 4 makes a qualitative assessment of technology options, showing which are most relevant for application on islands today. The technology options are assessed from an economic points of view in Chapter 5, providing a general cost comparison. Chapter 6 considers barriers and drivers to the deployment of renewable desalination on islands and also includes a list of relevant networks and organisations, including best practices for renewable desalination deployment.

2 Assessment of Island Markets for Renewable Energy Desalination Technology

2.1 General Boundary Conditions on Potential Islands

Low-lying islands and coral atolls often face scarcity in both ground and surface water [1-3]. Some islands have no surface water or water storage and thus depend entirely on rainwater [4]. Steep topography and limited low-lying flat areas, soil erosion, highly impermeable rock and short river channels, all stand in the way of natural water storage [5]. Limited surface area and limited water storage capacity, combined with rising demand for water in growing economies, may lead to fresh water scarcity on islands and prompt the need for desalination [4].

Climate change may mean rising air and sea-surface temperatures, intensified droughts during dry winter months and more severe floods during wet summer months [6]. Rising sea levels and more intense tropical cyclones are likely to threaten low-lying islands and coral atolls [6]. Together, these factors are apt to adversely affect fresh water supplies and raise the need for cost-effective desalination systems on islands.

The climate of different islands varies. Most islands in the Pacific, Caribbean, African, Indian Ocean, Mediterranean or South China Sea are in tropical latitudes near the equator and have alternating wet and dry seasons each year [7]. But in the Mediterranean and Atlantic, islands are far from the equator and may experience semi-arid climates [4].

Rainfall patterns on islands also vary distinctively. For islands near the equator, the trade winds blow from the Southeast in the southern hemisphere and from the Northeast in the northern hemisphere [8]. Trade winds usually carry large amounts of moisture which condenses when they reach island land masses. Resulting precipitation depends on island topology, location and wind direction [8]. The windward coasts of islands with higher elevations are often fairly wet, whereas leeward coasts tend to be fairly dry [6].

Most islands have wide, low-lying coastal areas and are sensitive to flooding. Salt water intrusion threatens the groundwater resources of smaller islands following typhoons. Droughts threaten fresh water supply in low-lying atolls and the leeward coasts of larger islands. Both typhoons and droughts are projected to become more intense and frequent in the future [8, 9].

Pacific islands see different patterns of precipitation due to the trade winds shaping the Intertropical and South Pacific Convergence Zones [6]. The central and western Pacific islands face greater risk of floods and droughts than islands in the eastern Pacific [6]. Large, high volcanic islands tend to have fertile soil and sufficient fresh water [8]. Low-lying atolls, however, often have poor soil and limited fresh water resources [8].

As trade winds are prevalent around the globe in areas close to the equator, their influences can be encountered on Caribbean, Atlantic and Indian Ocean islands too. Climate conditions, such as rainfall patterns, can vary strongly depending on the region [5]. The Mediterranean and Atlantic islands with a semi-arid climate tend to have their water supply availability dependent on the timing and amount of precipitation [4]. In the Mediterranean, precipitation may change annually and seasonally with recurring extended periods of drought [10].

Natural water resources on islands can be divided into surface water and groundwater. Surface water includes temporary and persistent streams, springs, lakes and swamps. Islands with fairly high elevation tend to have surface water in the form of streams and rivers whereas low-lying islands have neither persistent nor temporary streams [5]. Most streams are of a temporary nature and may flow for a couple of hours per day after rainfall. Persistent surface water streams will most likely occur in high volcanic islands where rocks have low permeability [8]. Even persistent streams may dry out during prolonged droughts [8]. Temporary streams, also known as surface run-off, frequently emerge immediately after rainfall and diminish within hours [5]. Rainwater run-off may be increased significantly by deforestation, attributed to soil compaction [5]. Other surface waters found on islands, such as lakes and swamps, are often brackish and not directly usable as fresh water sources [8].

Groundwater on small islands may be found in perched aquifers well above sea level and basal aquifers close to sea level. Basal aquifers can be found on most islands, except for those consisting of rocks with very low permeability, and often have greater storage capacity than perched aquifers [5]. Basal aquifers most often form fresh water 'lenses' less than five metres high that float on top of seawater [5]. Due to their low elevation, basal aquifers are susceptible to salt water intrusion, especially when overexploited or during periods of drought [4; 8]. Salt water intrusion leads to the temporary or even permanent deterioration of water quality [4].

2.2 Desalination Demand and Installation on Islands

According to the Intergovernmental Panel on Climate Change (IPCC) the 2014 report noted that climate change is very likely to exacerbate fresh water scarcity in the coming years [11]. It is also predicted to significantly reduce renewable surface water and groundwater resources as well as rain water quality [11].

Decreasing rainfall will impose freshwater scarcity, more frequent droughts, coastal erosion and possible salinisation of water supplies from strong waves and storms [6]. Desalination will therefore be needed on many islands to meet water demand during dry summer months, tourist seasons and droughts. On several islands, reclaimed municipal wastewater is also an important artificial water source.

This study uses water withdrawal to assess desalination requirements because it is a more objective measure of need than water demand [12]. Table 1 shows an overview of average water withdrawal for selected SIDS and developed countries. It emphasises the huge differences in total withdrawal, as well as distribution of withdrawn fresh water quantities for domestic, industrial and agricultural use.

Table 1: Fresh Water Withdrawal by Use for Selected Locations
(litres of water per person per day)

	Total withdrawal	Domestic use	Industrial use	Agricultural use
Antigua/Barbuda	155	93	31	31
Australia	7,621	1,122	764	5,735
Barbados	961	321	424	211
Cabo Verde	107	7	2	97
Cyprus	654	178	9	467
Fiji	225	31	31	159
France	1,450	228	1,080	142
Germany	1,269	157	861	251
Madagascar	2,034	57	32	1,945
Maldives	26	26	1	0
Papua New Guinea	40	22	17	1
Singapore	108	48	55	4
United Kingdom	520	113	392	15
United States	4,159	528	1,915	1,716

Source: [13]

Tourism strongly influences fresh water demand and withdrawal rates. The typical tourist consumes around 300 litres of fresh water per day, but this average can reach up to 880 litres/day in luxury resorts [14]. It is less than 50 litres on some SIDS.

For any given location, desalination demand and water quality needs have to be assessed separately. Agricultural or industrial fresh water may require lower standards of water quality (higher salinity, no post-treatment) or a different technological approach (such as systems driven by waste heat), compared to fresh water for domestic use. Fresh water supply and desalination demand strongly depends on island topology and climate.

Many islands have already integrated desalination in their water management plans, and a significant amount of desalination capacity has been installed. Most of the installed capacity can be attributed to small systems that produce less than 1,000 m³ of desalinated water per day and medium-sized systems producing up to 10,000 m³/day. Figure 1 shows the distribution of desalination capacity and technologies installed worldwide (left-hand pie chart) and the distribution in a range of selected SIDS [15] (right-hand pie chart). The islands were selected according to geographical representation and data availability. Reverse Osmosis (RO) uses membranes to separate fresh water from sea brine or brackish water and accounts for six out of seven litres of water desalinated on these islands. Thermal systems rely on heat to desalinate sea or brackish water, and provide about one in seven litres of desalinated island water. These include

systems that utilise multi-stage flash (MSF) and MED. Electrodialysis (ED) can only be applied for brackish water with low salt content and is therefore responsible for only a minor share of desalination capacities.

Figure 1: Desalination capacity shares by technology World-wide (left) and for selected SIDS (right)

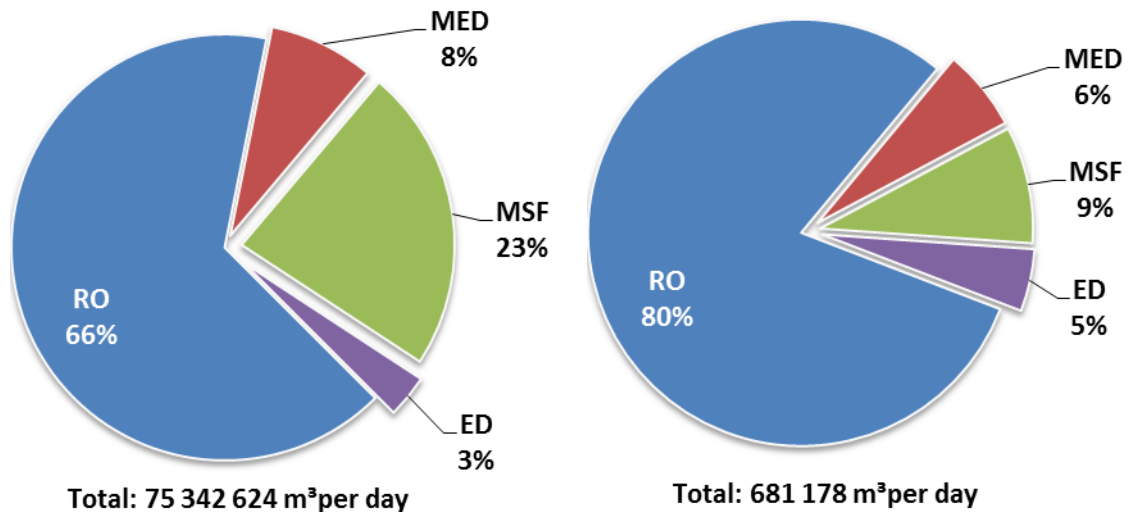

* The selected SIDS include: Antigua and Barbuda, Bahamas, Barbados, Cuba, Dominican Republic, Saint Lucia, Saint Vincent and the Grenadines, Trinidad and Tobago, Cabo Verde, Comoros, Maldives, Mauritius, Seychelles, Fiji, Kiribati, Marshall islands, Papua-New Guinea.

2.3 Desalination Technologies and Capacities – Island Case Studies

Many islands already have fossil-fuel desalination systems, but many are switching to use renewable energy [15].

Desalination technologies and capacities for a representative range of islands are described in this section. These were chosen to reflect a variety of locations, population, topologies and climate conditions.

Cabo Verde has a fairly sophisticated desalination infrastructure with 29 desalination plants, of which only four are presumed offshore [15]. The first desalination plants on Cabo Verde were built in the 1970s. Today, most plants are of small capacity at around 1,000 m³/day. Smaller desalination plants have a capacity of 100–500 m³/day and the capacity of a few larger ones are in the range of 2,000–5,000 m³/day. A newly planned Sea Water Reverse Osmosis (SWRO) desalination plant on Santiago, the largest island in the archipelago, is expected to have a capacity of about 40,000 m³/day [15]. Desalination plants on Cabo Verde are mostly based on RO and MED, with RO being the dominant and up-to-date desalination technology [15]. Multi-effect distillation (MED) and MSF plants were installed in 1979-1999. The overall desalination capacity installed in Cabo Verde is 35,000 m³/day [15]. The total desalination installed capacity operating on the island of Sal is presumed to be about 5,000 m³/day [15].

Greece has a very advanced desalination infrastructure with a daily desalination installed capacity of about 200,000 m³. The Greek island of Mykonos has four RO desalination plants with a daily capacity of 500 m³, 1,200 m³, 2,000 m³ and 4,500 m³ respectively [15]. The first desalination plant on Mykonos was built in 1980 (500 m³/day) and the most recent one was built in 2008 (4,500 m³/day) [15].

Antigua and Barbuda has an overall desalination installed capacity of about 85,000 m³/day, most of which is based on RO. Of the 25 desalination plants, six are presumed non-operational and of those five were built in the 1970s, and each equipped with MSF technology. Desalination capacities of the onstream plants are mostly around 100-3,000 m³/day. One plant has a capacity of 9,000 m³/day and two plants have about 17,500 m³/day [15].

Barbuda only has about 1,500 inhabitants and three RO desalination plants. These have a capacity of 545 m³/day, 380 m³/day and 246 m³/day respectively [15].

Grenada has installed one RO desalination plant at its southern tip, and has a capacity of 500 m³/day [15]. Further RO desalination capacities are to be constructed on the small outlying islands of Carriacou and Petit Martinique, funded by the CARICOM Climate Change Centre [16]. A capacity of about 400 m³/day is planned for Carriacou, and the plant's electricity needs are to be provided by solar power [17]. Former desalination plants in the region with initial costs of about USD 5 million were shut down or completely dismantled. This was due to poor plant locations, limited storage capacity and limited local acceptance of desalinated water.

Kiribati has one minor SWRO plant with a capacity of only 110 m³/day on Betio, a small island at the southern end of South Tarawa [15]. The plant was installed in 1999 at the peak of a series of droughts [18]. Two further RO desalination plants, each with a capacity of 50 m³/day, were donated by China and are installed at a local hospital and hotel [18]. Total desalination capacity is around 210 m³/day.

Vanuatu has a desalination capacity of 96 m³/day from two new solar-powered RO desalination plants that are installed on the islands of Ambae and Aniwa. These plants are built to provide fresh water to about 11,000 people [15].

The characteristics of these islands are summarised in Table 2.

Table 2: Characteristics of Selected Islands

Island/state	Area	Population (per 1,000)	Size (km ²)*	Climate	Topology	Main Economic Sectors	Desal. Capacity (m ³ /day)
Cabo Verde	Atlantic	516.0	4,300	Semi-arid	Volcanic, steep, high mountains	Remittances, tourism	82,000
Mykonos/Greece	Mediterranean	10.0	105	Semi-arid	Rocky, small mountains	Tourism	8,200
Antigua and Barbuda	Caribbean	85.6	440	Tropical	Flat, coral limestone	Tourism	85,000
Grenada	Caribbean	105.5	340	Tropical	Volcanic, central mountains	Tourism	500
Kiribati	Pacific	103.0	810	Tropical	Flat, coral atoll	Copra, international aid, tourism	210
Vanuatu	Pacific	243.3	12,190	Tropical	One large volcano (ca. 1,500 m)	Agriculture Fishing, offshore financial services, tourism	192

*square kilometres

Source: [20, 21]

The size of desalination systems deployed depends on infrastructure, demographics and local hydrology. This means desalination system capacities on islands cannot be derived simply from overall population or island size. Most island systems have fairly low capacities of 200-20,000 m³/day, serving only minor proportions of the island populations.

The desalination capacity installed on islands today varies widely, but desalination is increasingly finding its way into island markets so that they can manage fresh water supply constraints. RO powered by electricity is the prevailing desalination technology for newly built plants in most of these desalination systems. This is because it is technologically mature and been proven to be economically viable in the long term [22, 23].

2.4 Cost of Electricity

In this section, the high cost of island electricity generation is discussed as a key driver affecting the decision to desalinate – in particular the relative cost-effectiveness of fossil-fuel or renewable desalination systems. Generation costs are based on the actual costs of capital, fuel and O&M incurred by electricity suppliers. The electricity tariffs paid by customers do not always reflect the full generation costs, in which case, incentives to shift to least-cost options may be eroded. Even though renewable energy systems are attracting attention on some islands [24], most of them still rely on fossil-fuel systems.

Levelised Cost of Electricity on Islands

In remote regions, electricity supply is often provided by diesel generators. The levelised cost of electricity (LCOE) from diesel power generation for varying diesel prices is shown in Figure 2 and the calculation method for LCOE is described in annex I. Table 3 displays the assumptions on which LCOE calculations are based.

Table 3: Input Data for Calculating Levelised Cost of Electricity

	Unit	Small generator	Large generator	Reference
Full load hours	h/a	2,000-4,000	7,000-8,000	[25]
CAPEX ^a	USD/kW ^c	260-520	780-1,170	[26],[27]
OPEX ^b	USD/kWh ^d	0.026	0.039	[27]
Efficiency	%	30-40	40-45	[26],[28]
Lifetime	Years	20	20	[29]
Calorific value	kWh _{th} ^e /kg ^f	11.6	11.6	[25]
Diesel price	USD/litre	1.00-2.00	1.00-2.00	[30-33]

^acapital expenditure, ^boperating expenditure, ^ckilowatt, ^dkilowatt-hour, ^ekilowatt-hour_{thermal} ^fkilogram

A distinction is made between small generators (less than 50 kilowatt (kW)) and large generators (more than 10 megawatts (MW)). With 2,000-4,000 full load hours, a 50 kW generator produces 100,000-200,000 kilowatt-hour (kWh) per year, suitable for about 20-80 households. A 10 MW generator running for 7,000-8,000 full load hours per year can produce 70,000-80,000 megawatt-hours (MWh) per year (this is a minimum since it may be used to generate electricity for a large region). This is enough for about 26,000-30,000 households. The diesel price on islands is assumed at USD 1-2 per litre [34].

The CAPEX (capital expenditure) prices are obtained from market research. The lower CAPEX for smaller diesel generators is probably due to economies of scale in production, since small gensets are manufactured in substantially higher volumes than large ones. Smaller generators run far fewer hours than large ones and can therefore be built less sturdily with lower material requirements. This is another reason for the price difference. Finally, small gensets are not as efficient at burning fuel as the larger units. The design of larger units to be more efficient, is critical as they operate for longer and this has substantial cost implications. As shown in Figure 2, the higher capital costs of large diesel units per kilowatt pay off in terms of lower costs per kilowatt-hour. This is because the larger units are more efficient at burning costly fuel, and their capital costs are spread over more operating hours.

Figure 2: Levelised Cost of Electricity as a Function of Diesel Prices and Generator Size

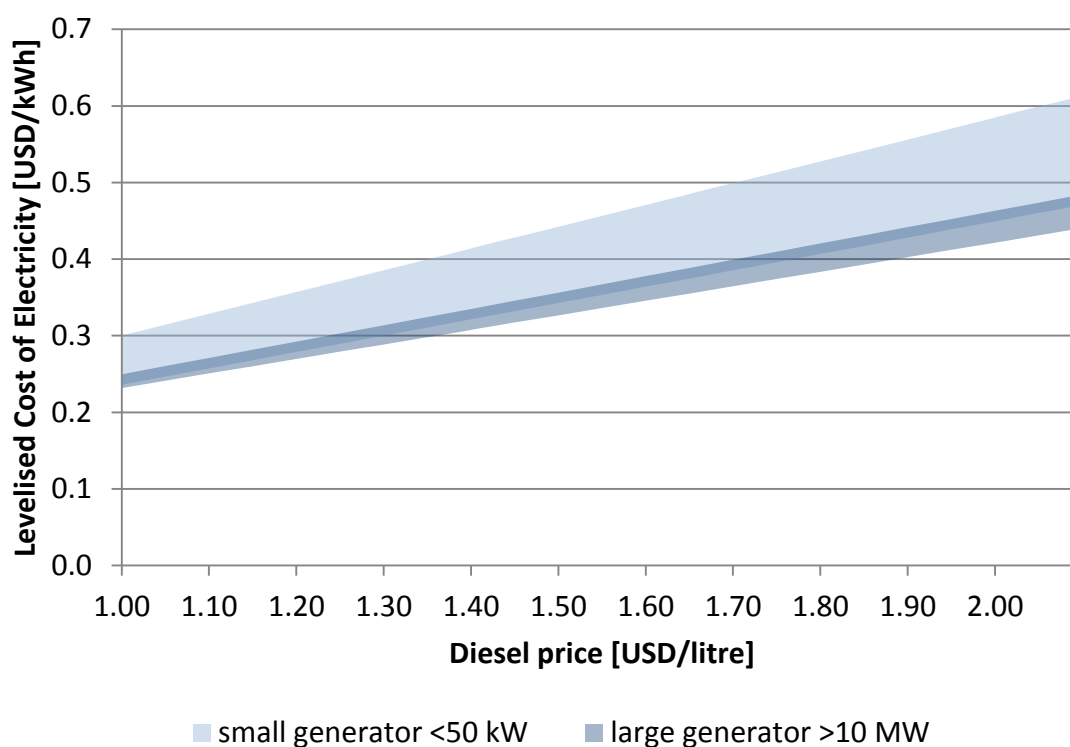

LCOE for small generators is 0.23-0.3 USD/kWh for a diesel price of USD 1 per litre. This rises to 0.47-0.61 USD/kWh for a diesel price of USD 2 per litre. The LCOE for large generators is 0.23-0.25 USD/kWh for a diesel price of USD 1 per litre, and 0.44-0.48 USD/kWh for a diesel price of USD 2 per litre.

Cost and Price of Electricity

The price of electricity on islands is generally high due to the increased costs of fuel imports for power generation. However, these costs and prices vary widely by location and degree of isolation. Table 4 shows the cost of electricity supply on islands can be much higher than the price paid by consumers, and the difference is subsidised. This can consist of a payment from the government or a cross-subsidy from other types of consumers. For example, in Kiribati about 25% of the import budget is spent on fuel [35]. In Cabo Verde, the price is kept constant across all islands through cross-subsidisation. In Fiji, which has substantial amounts of low-cost hydropower, the electricity price is lower than the cost of diesel generation without the need for subsidy.

Table 4: Electricity Prices and Costs on Selected Islands

	Electricity price [USD/kWh]		Average cost of electricity [USD/kWh]	Source
	Household	Industry		
Kiribati	0.32	0.44	0.57	[30]
Cabo Verde	0.33	0.33	0.41	[31]
Fiji	0.09	0.18	0.15	[32] [33]
Solomon islands	0.83	0.89	Not available	[36]

2.5 Cost of Water

The cost of water supply on an island depends on the type of water supply system. This can be based on ground or surface water, desalination or imported shipments. Few statistics are available for water costs and tariffs on islands. Since water supply is local, water prices within countries can vary considerably. This section analyses the costs of desalination systems driven by fossil fuel. RO and MED are the technologies assessed, as these account for the bulk of installed and planned capacity. The calculation method for the levelised cost of water production (LWC) is described in annex II.

LWC was calculated for plant capacities of 250-2,000 m³/day. These sizes can serve 2,300-18,000 inhabitants assuming per capita annual average consumption of roughly 40 m³ (World Health Organisation definition of optimal water access) [37]. The cost assumptions for RO and MED desalination plants are given in Table 5 and Table 6. The main variable is the cost of electricity. To cover a range of different plant sizes (250 m³/day and 2,000 m³/day), CAPEX varies in the calculation.

Table 5: Input Data for Calculating Levelised Water Costs of RO Plants

	Unit	Value	Reference
CAPEX	USD/m ³ /day	1,930-2,320	[38]
OPEX except electricity	USD/m ³	0.32	[39]
Electricity demand	kWh/m ³	4.30	[39]
Electricity cost	USD/kWh	0.20-0.50	
Lifetime	years	25	[39]
Availability	%	94	[39]
WACC*	%	5; 10	[40]

*weighted average cost of capital

Table 6: Input Data for Calculating Levelised Water Costs of MED Plants

	Unit	Value	Reference
CAPEX		1,700	[39]
OPEX except electricity	USD/m ³	0.32	[39]
Electricity demand	kWh/m ³	1.55	[39]
Electricity cost	USD/kWh	0.20-0.50	
Heat demand	kWh/m ³	52.65	[39]
Fuel price	USD/litre	1.0-2.0	
Lifetime	years	25	[39]
Availability	%	94	[39]
WACC	%	5; 10	[40]

Figure 3: Levelised Water Cost for RO Plants Producing 250-2,000 m³/day

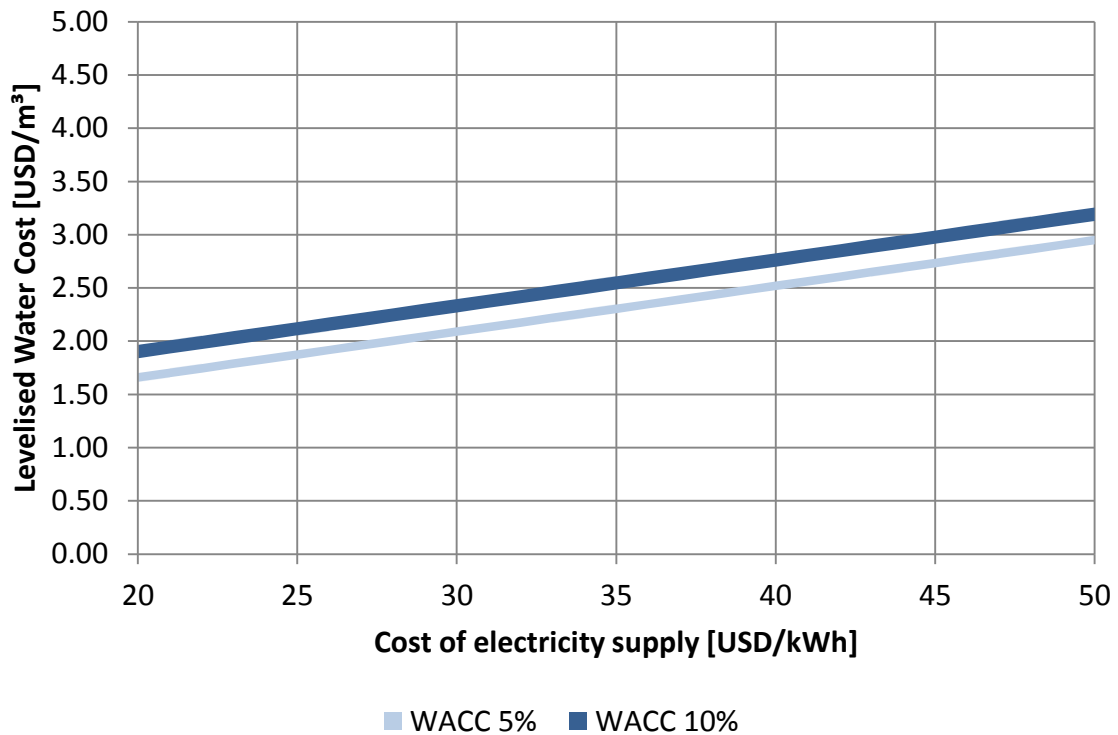

The LWC from a diesel-MED desalination plant is shown in Figure 4. With a WACC of 5%, the LWC ranges from 4.80 USD/m³ at a diesel fuel cost of USD 1.00 per litre to around 9.00 USD/m³ at a diesel price of USD 2.00 per litre. This depends on an electricity price of 0.20-0.50 USD/kWh. With a WACC of 10%, the costs are slightly higher at 5.00-9.20 USD/m³.

In many cases MED plants are coupled with electricity generation plants in order to utilise their waste heat. The cost of fuel is then mostly allocated to the electricity generation, which means the fuel for the MED plant is almost free of charge.

Figure 4: Levelised Water Cost of MED Plant with Electricity Prices at 0.20-0.50 USD/kWh

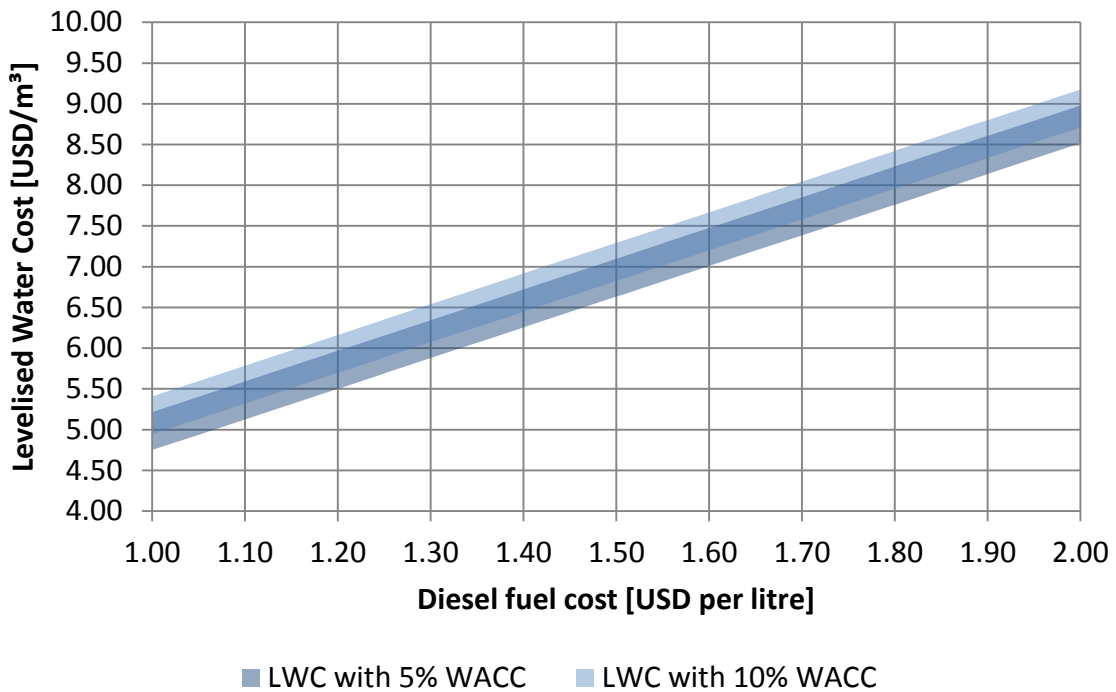
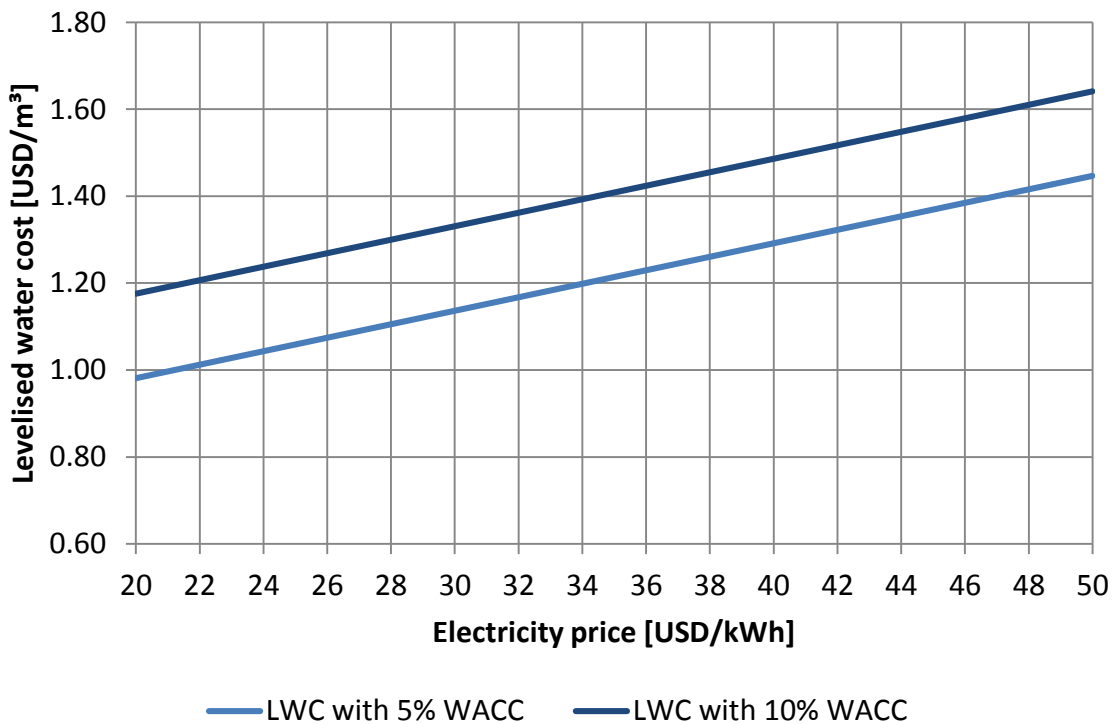

Figure 5 shows the levelised water cost for a MED plant driven by waste heat without any allocated fuel cost. The levelised water cost then ranges between 1.00-1.60 USD/m³ depending on electricity price and cost of capital.

Figure 5: Levelised Water Cost of Waste-heat MED Plants at Varying Electricity Prices



Cost and Price of Water

According to Cipollina, Micale and Rizzuti (2009) [41], the estimated cost for large-scale fossil-fuel water desalination systems are as follows:

- Seawater RO: 0.48-2.1 USD/m³
- Brackish water RO: 0.21-0.75 USD/m³
- MED and MSF: 0.69-2.1 USD/m³

The levelised cost for desalinated water does not represent the full cost of water supplied to the customer. The cost for water distribution needs to be added, including infrastructure and O&M costs as well as taxes.

The cost and price of water can vary as a result of subsidies. Prices on a range of islands outlined in Table 7 differ widely between approximately 0.6-6.7 USD/m³. Vanuatu has the lowest water prices at 0.59-0.89 USD/m³ while Cabo Verde has the highest, reaching 6.76 USD/m³.

Table 7: Water Prices on Selected Islands

	Fixed rate [USD/month]	Specific low water price [USD/m ³]	Specific high water price [USD/m ³]	Source
Grenada	4.00	0.79	1.98	[83]
Tarawa	8.87			[84]
Cabo Verde		3.65	6.76	[85]
Mykonos	1.33	0.99	3.32	[86]
Vanuatu		0.56	0.85	[87]
Barbuda		2.05	4.89	[88]

3 Description and Evaluation of Desalination Technologies for Island Applications

Different options exist to describe and evaluate desalination technologies. The most common method is based on an energy type that is thermal or electrical as prime mover for the process of separating fresh water from the salty feed solution. A distinction is made between evaporation, or phase change, and membrane processes. Most of the thermal desalination technologies are evaporative, such as MSF or MED. Most of the electricity technologies are membrane processes, such as RO or ED. Nevertheless, some technologies use electricity to evaporate water like mechanical vapour compression (MVC). Alternatively, they use heat as prime mover but have a membrane to separate distillate from the salty feed solution, as in the case of membrane distillation (MD). Thermal desalination systems also need reasonable amounts of electricity for feed and circulation pumps, control and auxiliary equipment. Some very small manually refillable systems are an exception to this.

To compare different desalination technologies, the most common parameter used is the unit cost of water produced. This is calculated from investment costs, cost of capital and operating costs, which depend on many different boundary conditions, such as raw water composition, cost of energy and salaries. The requirements for preparation of intake water and treatment of fresh water produced vary strongly across all the different technological approaches. Some systems require extensive preparation using chemicals, whereas others, such as thermal systems, produce very water with low salinity that requires post-treatment to be palatable and used as drinking water.

The particular energy demand of a desalination plant is a very simple parameter that can be calculated from the amount of energy required to produce a certain quantity of fresh water. It is typically specified in kWh/m³. In electric systems this clearly addresses the electricity demand of the plant but in thermal systems thermal energy demand must be considered too. This makes cost calculations more difficult, since cost determination for heat is not always clearly defined, as in the case of solar thermal power plants. One methodology employs a conversion ratio to compare the energy demand of thermal and electric desalination plants. This calculates the deployed heat and electrical energy equivalent that could be produced with a particular amount and property of heat. This can be considered a thermal-electrical energy equivalent.

In electric desalination systems exclusively supplied by photovoltaic (PV) or wind turbines, the energy costs can be matched more clearly with the investment and operating costs of the PV or wind generator. This is also true for solar thermal systems if the purpose of the solar thermal collector field is heat supply for the desalination system only. However multi-generation processes with different consumers are more complex, such as CSP for power and heat supply.

3.1 Thermally Driven Desalination Technologies

Multi-Stage Flash Evaporation

Multi-stage flash (MSF) is the classic industrial-scale thermal seawater desalination process. It uses heat to rapidly ‘flash’ evaporate saline waters in a low pressure atmosphere. The core element is the flashing chamber. This includes a brine sump from which flash evaporation takes place, a horizontal tube bundle condenser and a distillate tray.

Figure shows a simplified diagram of MSF. The cold feedwater is heated as it passes through several flash chambers and acts as a coolant in the condenser tubes. As it leaves the last stage, it is heated up in the brine heater and then introduced to the brine sump. Since the flash chamber has lower pressure than the feed vapour pressure, flash evaporation of the feed occurs. The concentrated feed is then forwarded on to the second flash chamber. This again has a lower absolute pressure and generates further flash evaporation.

Figure 6: Diagram of a Multi-stage Flash Desalination System

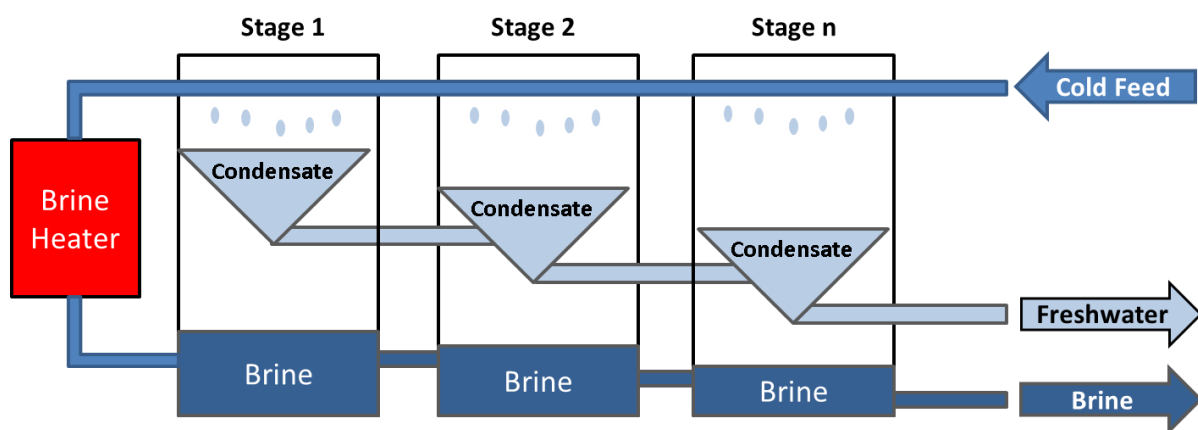

MSF systems yield a higher distillate quality than membrane desalination technologies with salinities below 10 parts per million. Most MSF plants are operated with motive steam from thermal power plants. Top brine temperatures in the process are around 112 degrees celsius (°C), which qualifies MSF for combination with solar thermal energy, especially CSP. MSF plant feedwater preparation is necessary. It may involve coarse filtering, chlorination, de-aeration, pH adjustment and/or antiscalant dosing.

Small MSF plants on islands do not appear to be economically viable. During the last decade, only six MSF plants have been commissioned, each with a capacity below 500 m³/day [15]. Their main disadvantages are very high electricity consumption at 3-4 kWh_{el}/m³ and the relatively high top brine temperature required. This significantly reduces the electrical power output and efficiency of the power plant (>10%).

MED technology, which needs significantly lower top brine temperatures and much lower electricity input, is therefore used much more often in small-scale applications.

Multi-Effect Distillation

The MED thermal desalination process uses heat to evaporate water in several consecutive vacuum chambers, also referred to as 'effects.' Figure shows a simplified diagram of a MED system. The motive steam is introduced into the evaporator tubes in the first effect. The feedwater is then distributed onto the outer side of the evaporator tubes using distribution sheets. Feedwater evaporates as it wets the outer surface of the warm tubes. The vapour is passed through a mesh demister into the evaporator tubes in the next effect. As the vapour condenses inside the evaporator tubes, the latent heat is transferred to the feedwater distributed to the outer shell. The water evaporates because the ambient pressure in the surrounding chamber is reduced. The repeated evaporation and condensation process continues in each effect, with more and more water being desalinated in each one.

Figure 7: Diagram of a Multi-effect Distillation System

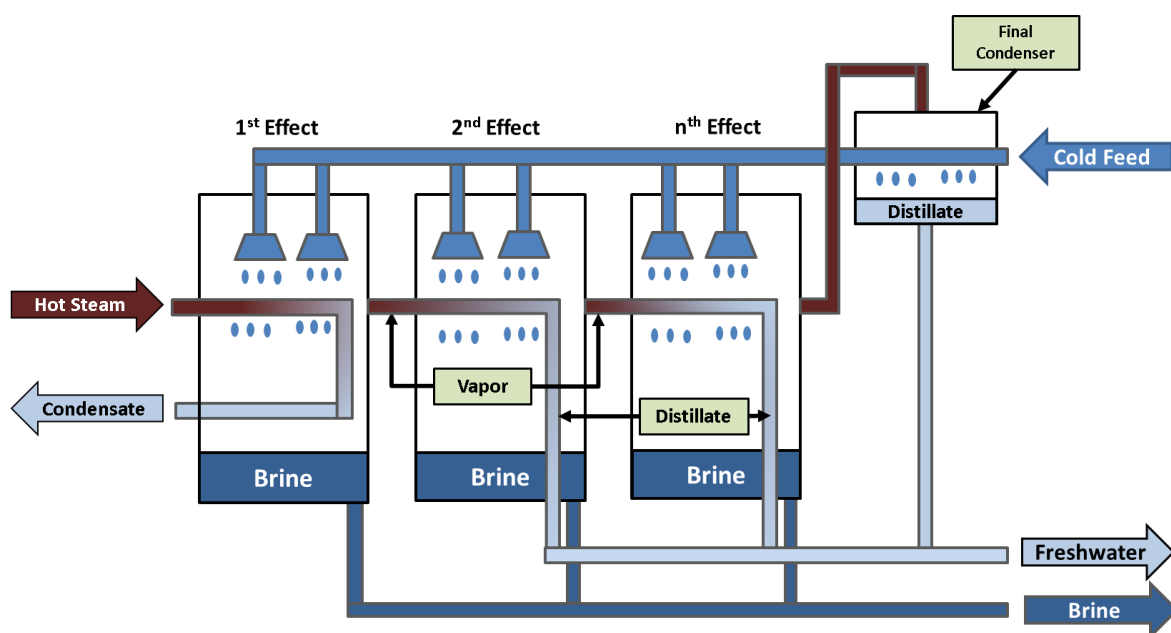

The ultimate concentration of brine within the system is dependent on the amount of feed distributed onto the evaporator tubes. The concentrated brine is collected in the evaporator sump and rejected. The vapour from the last effect is condensed within a final condenser.

As with MSF, the MED feedwater needs to be prepared through coarse filtration, chlorination, de-aeration, pH adjustment and/or anti-scalant dosing before being introduced into the core equipment. To avoid excessive corrosion, brine concentration is typically limited to about 65 grams (g) of salt per kilogram (kg) of salt water. As the process obtains desalinated water by evaporation and subsequent condensation, the produced fresh water is low in salinity and high in quality. Motive steam at medium temperatures of around 70°C is usually used to drive MED processes, and several renewable energy technologies can provide low pressure steam at this temperature. For example, the MED process can make direct use of low-grade waste heat from CSP plants or (at a smaller scale) solar thermal collectors. However, high thermal system capacity and the limited range of valid flow rates restrict the applicability of classical MED with renewable energy supply to fairly dynamic small-scale desalination systems.

Many industrial MED systems apply thermal vapour compression (TVC) to enhance heat recovery. The heat of the low temperature steam from the last effect is partially recovered by compressing it with the motive stream in a jet ejector. This allows a subsequent re-injection into the first or an intermediate stage (see also section on vapour compression).

The thermal energy demand and thus energy costs of MED systems are reduced as the number of effects increases while the required specific heat transfer area and consequently investment costs rise. The reduced pumping requirement due to the latent heat recovery concept is a major advantage of MED over MSF. This cuts electricity consumption to 1.2-2 kWh_{el}/m³. The output capacity of commercial MED units is 500-36,000 m³/day. However, the MED market also includes small units. During the last few years, around 50 MED plants with capacities below 100 m³/day and 150 MED plants with capacities below 500 m³/day have been commissioned each year. The MED approach seems to dominate the thermal desalination market as indicated by the significantly higher number of recent installations compared to MSF. MED benefits from high efficiencies, better heat transfer and less water recycling demand than MSF [42].

Vapour Compression (Mechanical and Thermal)

Mechanical Vapor Compression (MVC), is generally a thermal desalination technology, as can be seen in Figure 8, as it evaporates and condenses water for separation. The main MVC components include a compressor powered by electricity, a tube heat exchanger for evaporation, a feed distributor and a demister. The feedwater stream is preheated using heat from the distillate as well from the brine produced. The preheated feed is distributed on the evaporator tubes inside the evaporation chamber and then evaporated. The water vapour is sucked out of the evaporation chamber and compressed into the evaporator tubes. The vapour temperature increases as a result of compression. Due to the distribution of colder feedwater at lower pressure in the surrounding chamber, the feedwater evaporates. At the same time, the vapour in the tubes condenses at higher pressure and provides the latent heat for evaporation of feedwater on the outer shell.

Figure 8: Diagram of a Mechanical Vapour Compression System

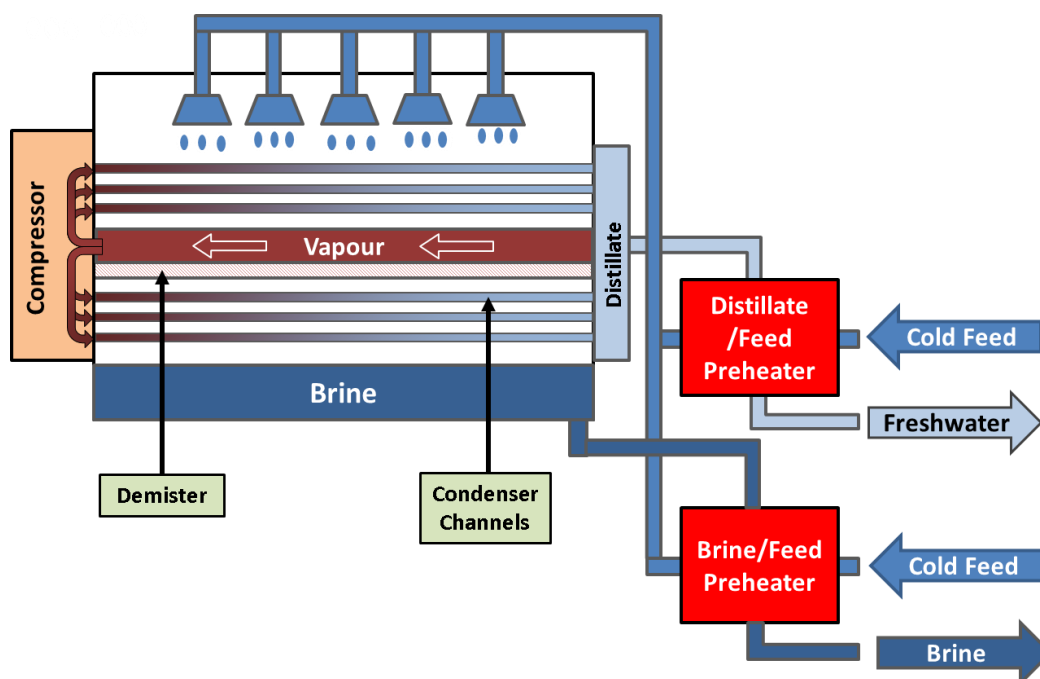

In TVC, a motive stream of high pressure taken from a steam turbine, for instance, is employed to pressurise the vapour via a motive steam jet ejector. TVC is typically used in MED systems, improving their overall system efficiency. However, MVC can also be applied.

Vapour compression is mostly used with desalination systems of less than 5,000 m³/day [41]. As also clear from section 2.2, the share of MVC and TVC in desalination capacities worldwide is negligible. MVC has quite high energy demand, requiring about 10–14 kWh_{el}/m³ [43].

3.2 Electric Desalination Technologies

Reverse Osmosis

RO separation depends on non-porous membranes that for water molecules are significantly more soluble and diffusive, than for salts. The natural osmosis aims to balance a concentration difference of the two solutions. This is countered by artificially applying a high absolute pressure difference between highly saline water to fresh water, exceeding the osmotic pressure difference naturally experienced by the respective salinities. The principal set-up of RO units including a pressure recovery device is illustrated in Figure 9. The osmotic pressure of a saline feed is directly proportionate to its salinity so the required pressure demand for RO increases almost proportionally to increasing feedwater salinities.

Figure 9: Diagram of a Reverse Osmosis Process Configuration

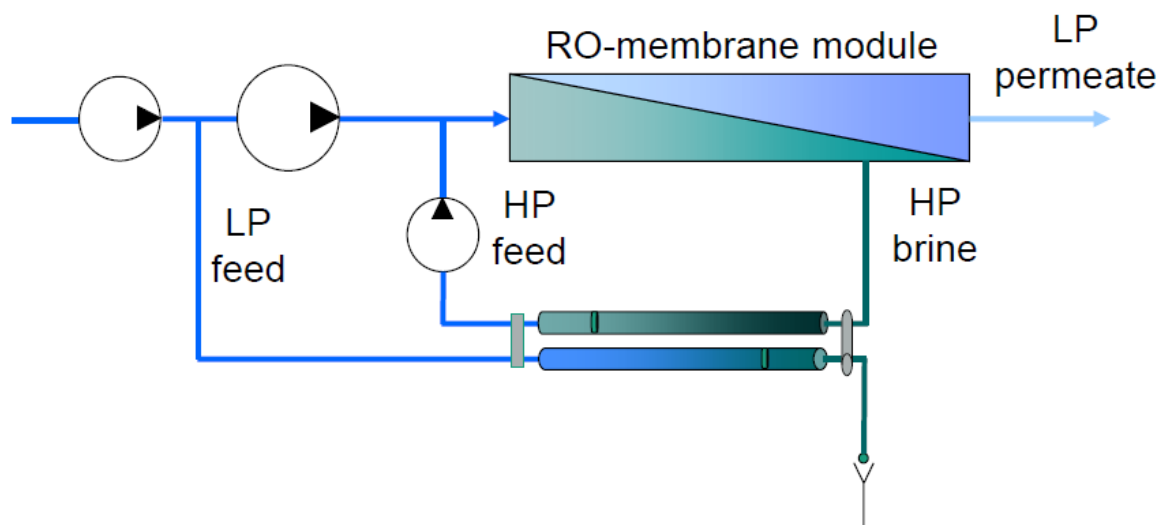

The economics of RO desalination are mainly defined by the feed pressure and recovery ratio - the amount of fresh water produced compared to feedwater introduced. Extensive water preparation is usually applied prior to the introduction of feedwater in RO desalination systems. This involves screens, chlorination, pH adjustment, coagulation/flocculation, filtration, dechlorination and antiscalant addition. Systems based on membranes using microfiltration or ultrafiltration have recently become a promising technique in RO preparation.

About 80% of the electrical energy requirement in RO systems relates to the high pressure pumps. In advanced RO systems, energy from the concentrate, which is still at high pressure when it leaves the RO module, can be recovered by energy exchangers. This reduces the pumped energy

required by about 30%-50%. The energy consumption of large-scale SWRO plants, including intake, preparation and brine disposal, is at 3.8-4.5 kWh_{el}/m³ [44]. Small systems may experience significantly higher energy consumption because they have smaller pumps and less efficient or no energy recovery. In general, RO is still considered sensitive to power fluctuation and therefore not well suited to transient operation with direct solar energy or wind energy supply. Nevertheless, demonstration systems already exist that can be operated with direct PV power without relying on batteries. These can be expected to enter the market in the near future.

A major RO advantage is modularity. This allows any plant to be designed from a tiny capacity of less than 1 m³/day to giant plants of up to 1,000,000 m³/day as currently planned in Caofeidian, China. The particular attractiveness of RO for smaller systems is reflected in a global market share exceeding 90% including systems with capacities of less than 1,000 m³/day [4]. RO systems are considered to have high potential for the direct application of renewable energy supply like wind or PV. As far as pressure and flow are concerned, RO membrane suppliers recommend continuous operation and smooth shutdown and start-up procedures [45]. Flushing the RO module with desalinated water is recommended when the system is shut down [45]. Thus RO systems require energy storage (e.g. electrical or mechanical) to handle energy supply changes when combined with fluctuating renewable energy sources. Energy storage requirements, smart operational strategies and resilience to dynamic operation and down time are important fields of future RO research and development (R&D).

Electrodialysis

Electrodialysis (ED) is a desalination technology mostly implemented to desalinate brackish water with low salinity. ED uses an electrical field introduced by a positively charged anode and a negatively charged cathode plate. This moves positively and negatively charged ions through semi-permeable selective anion and cation membranes, thus desalinating water. The selective anion and cation membranes are arranged alternately so that an anion can pass only one membrane on the way to the charged plate. It is thus captured in the concentrate channel.

Figure 10 shows a simplified diagram of a single-stage ED system. The anode and cathode of ED systems are at opposite ends with membranes in between separating the concentrated and diluted (fresh water) flow. The charge of the plates is established by an electrical current. The cost of ED desalination is directly proportional to the salinity of the feedwater [38]. ED is mostly used for brackish water desalination for which it is an economically viable approach. Recently, it has increasingly been replaced by nanofiltration [41, 46]. Combinations are feasible using renewable energy sources such as PV or wind. ED operates on direct current, which is an additional benefit given that PV produces a direct current power supply [47]. ED is viewed as robust and easier to operate and maintain than RO [1]. ED is not suitable for market-scale seawater desalination so it has rather limited applicability to small and remote islands.

Figure 10: Simplified Diagram of a Single-stage Electrodialysis System

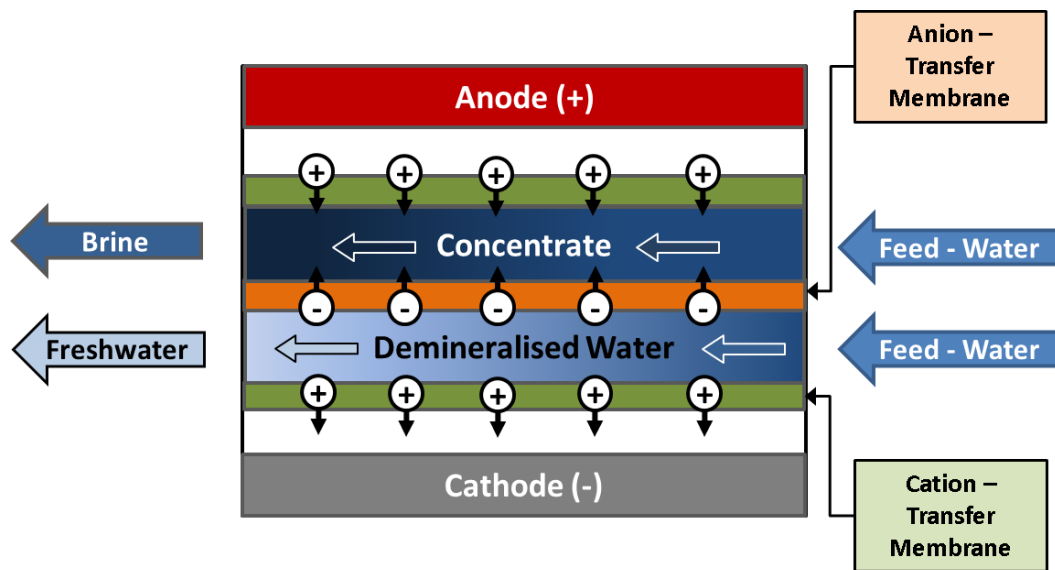

3.3 Unconventional Desalination Technologies

Solar Still

The solar still is probably the simplest system for brackish water or seawater desalination using direct solar energy. A possible design scheme for a simple solar still is shown in Figure 11, although more sophisticated solar still designs have been established in the last few years [41].

Figure 11: Diagram of a Simple Single Basin Solar Still for Water Desalination

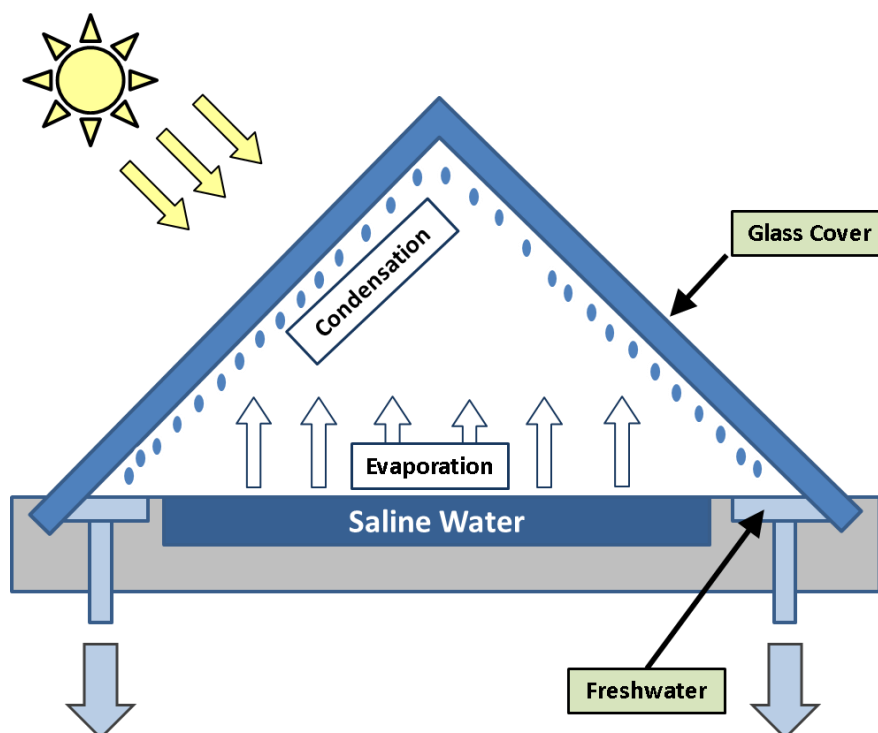

The solar still basically consists of a basin, mostly made of galvanised steel. It has an airtight seal in the form of a transparent cover mostly made of glass [41]. The bottom of the basin is mostly black to allow for maximum absorption of incident solar irradiation. Solar energy is absorbed within the basin while water and air heat up within the solar still, so that water evaporates and moisture content increases. The water is then condensed on the inner side of the glass cover because its temperature is lower than the heated humid air. As condensation takes place, water trickles down the glass cover for collection. During condensation, the entire latent heat disappears into the ambient air, but in more sophisticated desalination systems, it is partially recovered.

A simple solar still has an energy demand of about 700 kWh to evaporate 1 m³ of water, delivering about 3-5 litres/m²/day. Solar stills have two major drawbacks: a low output ratio (0.5) and a huge footprint caused by the low specific output [48].

Humidification/Dehumidification

A rather sophisticated advance to the solar still is the humidification/dehumidification (HDH) system shown in Figure 12. Using thermal energy, this humidifies air in a humidifier and then condenses air in a dehumidifier. HDH systems can be driven by solar energy, thermal energy such as waste heat or geothermal energy. There are two main types of HDH systems. The first is a closed-water open-air cycle, which circulates air through a humidifier and dehumidifier and subsequently releases it. The second is the closed-air cycle, which circulates air in a closed loop between humidifier and dehumidifier. Systems can be designed either to heat the air or the feedwater.

Figure 12: Diagram of a Simple Humidification/Dehumidification System

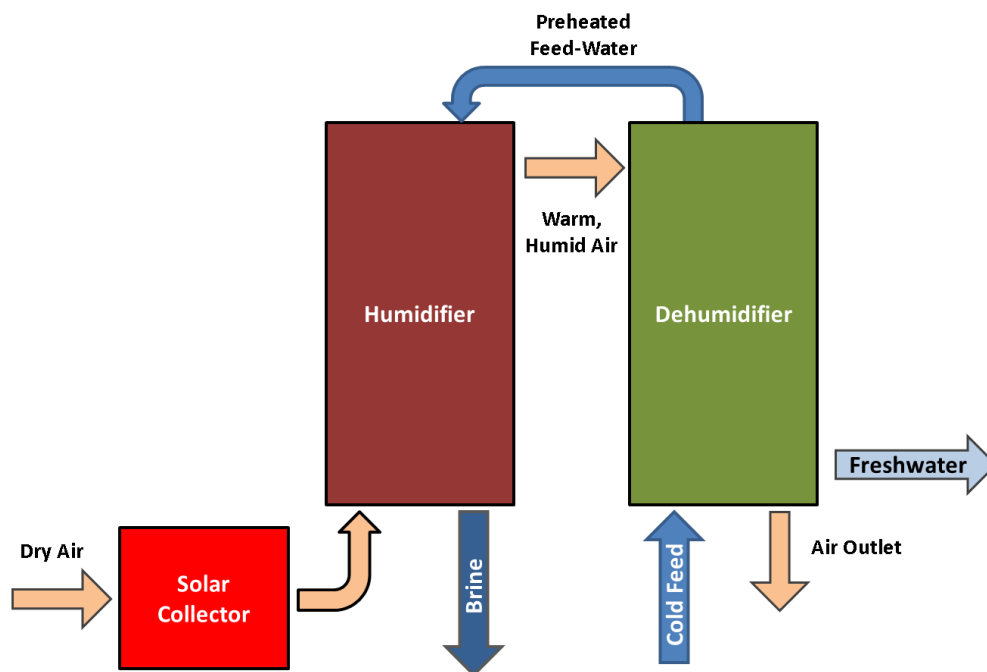

Source: [48]

HDH is mostly used in small-scale systems producing 50-500 m³/day. HDH systems are generally simple and thus easy to operate and maintain. However, they require a vast amount of space because of their poor efficiency [49].

Membrane Distillation

MD can be classified as a hybrid desalination technology combining thermal and membrane desalination. Heat evaporates and condenses water to desalinate it. In MD, distillation arises from the difference in the feed and condensate vapour pressures, which allows the process to operate at low feedwater temperatures of 60-90°C [41]. The hydrophobic, microporous MD membrane is permeable to vapour only and provides a greater gas-liquid interface area than other distillation processes.

The most basic is direct contact MD, as shown in Figure . Depending on the application, other MD systems like air-gap MD or vacuum MD can be more beneficial. As MD membranes are more insensitive to scaling and fouling than other membrane processes, preparation requirements are minimal and may be completed without using chemicals [49].

Figure 13: Diagram of Simple Direct Contact Membrane Distillation Setup

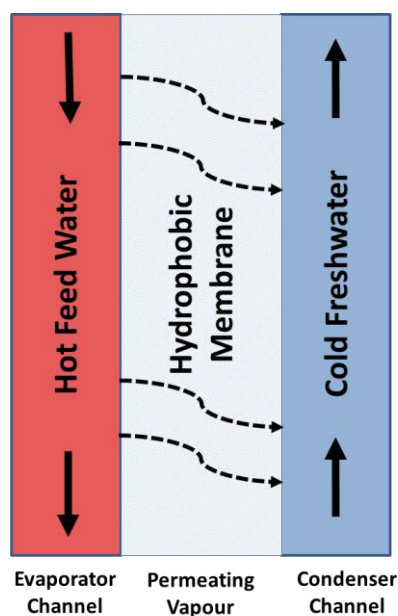

Source: [41]

They can use low-grade heat e.g. from cogeneration processes or solar thermal collectors. This means MD can be combined with renewable energy. Compared to other options like RO, MD systems are insensitive to fluctuations in energy supply. This makes them a promising combination with renewable energy. Desalination based on MD is still at the pilot stage. Several small-scale MD desalination systems are already operating and producing around 10 m³/day [49].

Ocean Thermal Energy Conversion

Ocean thermal energy conversion (OTEC) generates electricity from the thermal gradient between the warm upper and cool lower layers of the ocean. Sufficiently steep temperature gradients are mostly found in sunny regions near the equator, so OTEC is suited to energy generation on a wide range of islands. At water depths of 500-1,000 m, the temperature gradients are about 25°C [50]. OTEC feasibility in islands depend on particular geological conditions. For instance, deep water close to the shore allows the plant to be sited on land and industrial waste heat to be used in OTEC cycles to increase temperature gradients [51].

Open cycle OTEC systems are interesting because they allow direct seawater desalination. They evaporate seawater at a low-pressure atmosphere with the heat of the upper water layers. The steam is then expanded in a turbine and condensed using cooler water from the lower layers of the ocean. As seawater evaporates and condenses, fresh water can be extracted from the condenser.

The closed cycle OTEC approach produces electricity through an organic working fluid and a turbine. This is combined with electric desalination systems. The closed cycle OTEC design allows smaller systems than the open cycle design, as well as the use of established turbomachinery and components.

OTEC plant efficiencies are only 3%-5% [52], which requires enormous quantities of seawater and pumping for useful operation. Several proof-of-concept pilot OTEC plants have been operated, but no large-scale and commercially rational OTEC pilot plant has yet been built [51]. The environmental disadvantages of this technology have not yet been investigated. One drawback could be the redistribution of cool and nutrient-rich water from the lower to the upper water layers, which could disturb sensitive ecosystems. Pipes on the sea bed could be another disadvantage, disturbing ecosystems and leaking toxic working fluids [53, 54].

Given the state of the technology today, high mechanical component maintenance requirements and environmental impact uncertainties, OTEC does not yet appear to be a practical technology for island desalination. But as it matures and becomes cheaper, it may become more attractive, especially for small islands. Given the cost-intensiveness of diesel-powered electricity, OTEC may in the near future be seen as an economically competitive desalination and electricity generation technology [53].

Forward Osmosis

Forward Osmosis (FO) is a separation technology using membranes and working on the same underlying principle as RO. Nowadays, it is used in wastewater treatment, food processing, power generation and desalination [55]. FO requires a draw solution with high osmotic pressure and a feed solution (e.g. saline water) with low osmotic pressure to induce water permeation from each solution. The draw solution has to be recovered to generate fresh water. Thermal technologies (e.g. MD) or filtration technologies (e.g. nanofiltration or ultrafiltration) can be employed for this task.

FO has lower hydraulic pressure requirements than other separation technologies based on membranes. Its advantages include lower membrane fouling potential while water recovery is not limited by the mechanical stress caused by high operation pressure [55]. What is more, the quality of drinking water is high due to the presence of several barriers in the desalination process. Chemical preparation is not necessary due to the system's lower fouling potential [55]. FO systems

tend to be rather complex as they require a second water treatment technology for draw solution recovery. Furthermore, this requires additional energy and compromises the overall efficiency of FO compared to RO [56]. Only two FO desalination plants have been installed across the world, each with a capacity of 100–200 m³/day, and a third plant planned [38].

Freezing

Freezing desalination exploits the fact that freezing excludes dissolved salts from the ice [57]. The feedwater is cooled down until almost totally frozen, then washed and rinsed to remove salts and finally melted again to generate fresh water [57].

Freezing theoretically requires much less energy than evaporation (only about 15%) but still a great deal more than RO. It has hardly any scaling or fouling prevention requirements and thus needs minimal preparation [57]. Disadvantages include a rather high-tech cooling system and complicated frozen component movements [57]. Several pilot plants have been set up in recent years, but no commercial plant has yet been deployed [38, 57]. Freezing desalination can theoretically be combined with all technologies generating renewable electricity but also with solar thermal systems. For instance, it can use vapour compression as an energy source for cooling [22] or absorption chillers driven by solar thermal energy.

4 Renewable Desalination Technology Assessment

4.1 Potential Sources of Renewable Energy for Desalination

A variety of combinations of renewable energy sources and desalination methods are technically feasible but not all of them are technically and economically viable. Figure 14 gives a comprehensive overview of the possible combinations. To evaluate the basic potential combinations with desalination technologies, section 4.1 provides a short introduction to the major renewable energy sources. Section 4.2 assesses the most promising combinations taking into account technology maturity and future potential.

The sun is the largest renewable energy source. Irradiation can be exploited and converted into heat or electricity. Wind systems can be viewed as an effect of heat and radiation, inducing thermal gradients within the ocean or earth or by driving hydrological cycles. Tidal energy is another source of renewable energy, and is derived from the gravitational effects of celestial bodies. Energy derived from biomass is another. Geothermal energy can also be considered a very effective renewable heat source for thermal desalination because it is continuously available and allows steady state operation. However, it is only available in particular places, which creates an obstacle to its use. It is therefore excluded from this study. The major technologies for converting renewable energy sources into usable electrical or mechanical energy are described in the next sections.

Solar Thermal

Solar thermal energy is the conversion of solar irradiance into heat used for a variety of processes such as domestic hot water, domestic heating, industrial processes, cooling or desalination. Conversion takes place in solar thermal collectors containing an absorber sheet or absorber tubes run through with a working fluid (e.g. water) for heat transfer. Depending on the collector type (flat plate, evacuated flat plate, evacuated tube, etc.) working fluid temperature levels can rise to 200°C. The collector type also influences the efficiency. Due to heat radiation losses, this decreases to a greater or lesser extent depending on operational temperature [58]. Operating temperatures above 100°C at reasonable efficiency (more than 50%) can only be achieved using evacuated tube collectors.

Figure 14: Possible Combinations of Renewable Energy Sources and Desalination Technologies

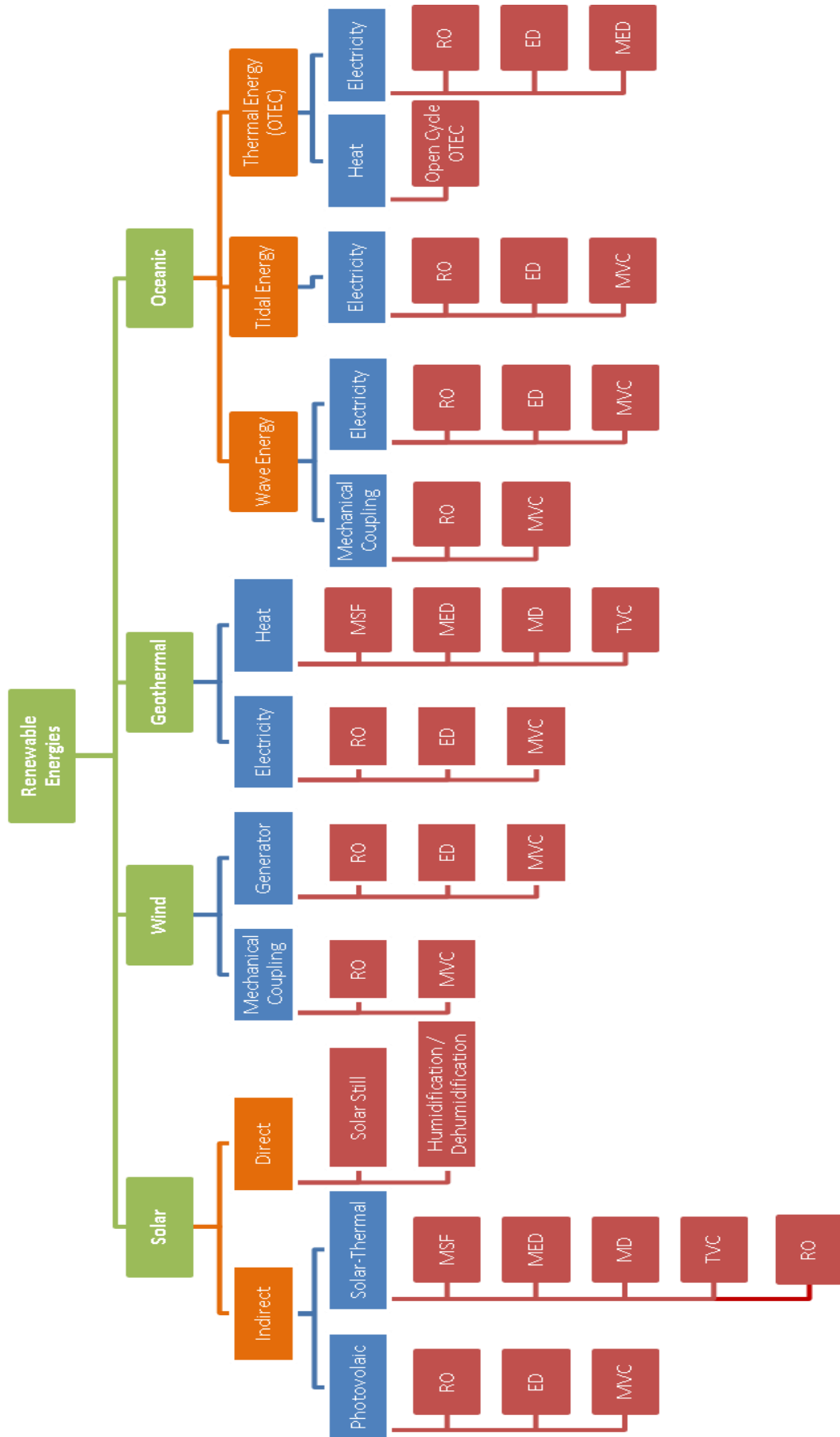

Concentrated Solar Power

Concentrated Solar Power (CSP) describes electricity production in thermal power plants where thermal energy for turbines is produced using solar irradiation. High temperatures are required (more than 500°C) to achieve reasonable efficiencies in steam turbines, so concentration of solar radiation is essential. This is typically achieved through a line focusing trough or special mirrors known as Fresnel mirrors focusing solar radiation onto an absorber tube. The heat is utilised to produce steam for a steam turbine. For higher temperatures (more than 1,000°C), heliostat fields are used, consisting of a vast amount of small mirrors focusing solar irradiation onto a spot receiver in a solar tower. Heat absorbed in the solar tower is then either used to drive a steam turbine directly or to supply a gas turbine which then delivers heat to a downstream steam turbine. CSP stores heat at relatively low cost to maintain the operation of the power plant during the evening peak load hours, and this is one of its main advantages.

When combined with desalination systems, CSP plant heat can be ejected from the low pressure steam turbine and fed to the brine heater instead of expanding in a further low pressure turbine. A final condenser is necessary in any case. In principle, the parabolic trough or Fresnel collector heat can also be used directly to supply a MED or MSF plant. This makes sense if the high temperature and high pressure delivered by the collector is utilised for the thermal compressor of a MED-TVC plant.

Photovoltaics

PV converts solar irradiation directly into electricity. PV cells are made of semiconductor materials through which a current is induced when exposed to solar irradiation. Connecting PV cells in a PV module produces a reasonable electrical performance. The most advanced silicon modules have an efficiency of 15%-20%. PV electricity generation efficiency can be increased using concentrated solar irradiation, e.g. parabolic mirrors or Fresnel lenses combined with appropriately designed PV cells (concentrated PV). The efficiency of PV cells decreases as temperatures rise, so intensive concentrated PV systems need active cell cooling. This heat can be utilised for different applications. Taking electrical and thermal energy output into account, overall efficiency can amount to around 80%.

PV systems can be directly coupled to all desalination technologies requiring electricity. Moreover, the heat from concentrated PV can be used to supply thermal desalination systems. PV desalination systems, which usually depend on RO units, are nowadays buffered by a grid connection or battery storage. The transient operation of PV-RO is still subject to R&D because a constant pressure and defined feed flow rate is recommended by RO suppliers. In future, a dynamically operated RO system could work as a flexible load in an island grid dominated by renewable energy. Output water would be stored instead of electricity.

Wind Energy

Wind energy can be converted to mechanical energy, thermal energy and electricity. Wind energy has been directly converted to mechanical energy for centuries, and it is possible to couple it mechanically to desalination systems like RO. Wind energy conversion to thermal energy is a rather exotic approach. Until today, wind has mostly been converted to electricity using wind turbines mechanically coupled to a generator system providing electricity.

To tolerate wind-fluctuations, electrical or mechanical energy storage can be integrated into wind desalination systems using flywheels, for example. Wind energy is a mature technology proven to be economically feasible when combined with desalination systems [10, 59, 60].

Geothermal Energy

Geothermal energy makes use of differences in temperature in the outer layers of the earth. Earth temperature gradients can vary greatly according to location, with a range of 15-75°C per kilometre [3]. Depending on site conditions, temperatures at an accessible depth can be high enough to drive heat pumps for low temperature heat. They can directly supply low temperature thermal desalination systems or even deliver heat to a whole steam-powered geothermal power plant.

Geothermal systems are a predictable and uninterrupted source of energy so no energy storage is required. This qualifies them as an energy source for sensitive desalination processes such as RO. Geothermal energy can be considered an economically viable energy source for desalination [10, 23], but only where local geological conditions allow [23]. Geothermal energy desalination systems have not yet been subject to extensive research [23].

Ocean Energy

Ocean energy, or marine energy, can be classified into tidal, wave and ocean thermal energy. Tidal energy is based on the interaction of celestial bodies, inducing tidal amplitudes. These provide potential energy by amplifying water and can be converted into electricity through a turbine coupled to a generator. Wave energy also makes use of water amplification to generate electricity either through a turbine or a piston system, although at lower energy levels than tidal. Ocean current energy is a hybrid of both and generates electricity from ocean currents via submerged turbines coupled to generators. OTEC can be used for either water desalination or energy production. Nearly all ocean energy technology systems are at pilot plant or prototype stage and not yet technologically mature or economically competitive [58]. OTEC is the most promising ocean energy approach for desalination. It may attract more attention in coming years as it develops and costs decline.

4.2 Assessment of Technically Mature Renewable Desalination

Renewable energy combined with desalination is only technologically and economically feasible if both technologies are mature and cost-effective for small-scale stand-alone island applications. Technically mature renewable energy sources include solar thermal, CSP, PV and wind energy. Technically mature desalination technologies expected to be coupled with renewable energy sources include MED, RO, ED, VC and simple solar stills. HDH and MD are moving from advanced R&D to market entry. Figure 15 provides an overview of the most sensible technologies as far as technical maturity and capacity ranges are concerned.

Figure 15: Maturity Level Versus Capacity Range of Specific Renewable Energy Desalination Technologies

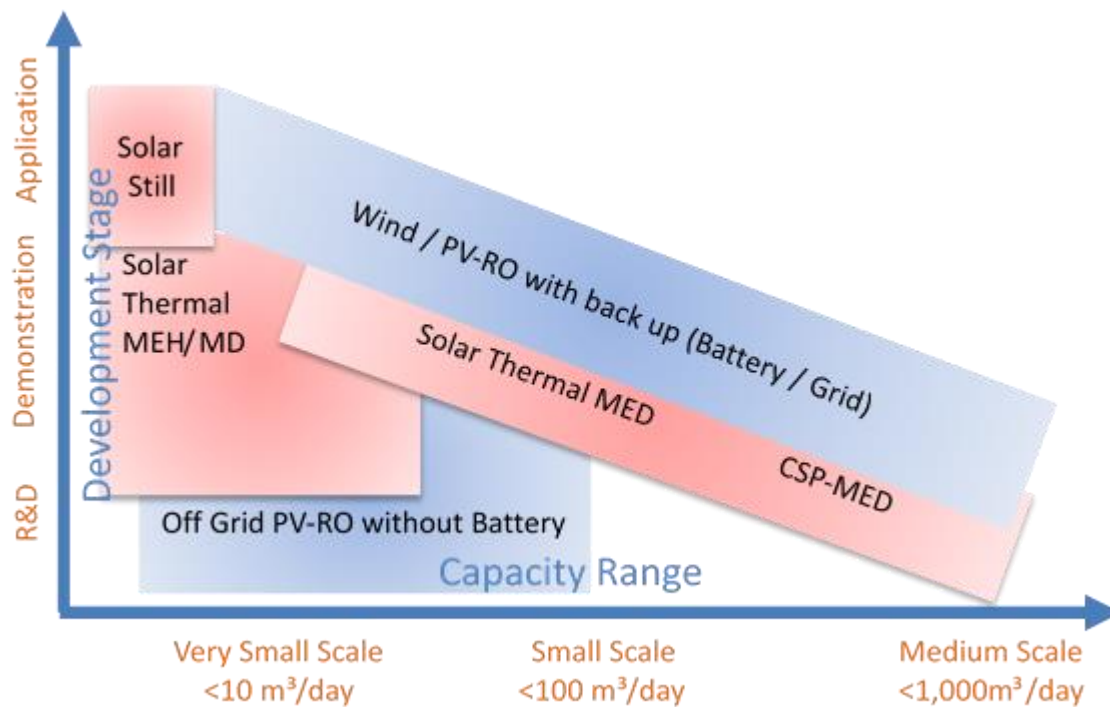

A few additional combinations approaching maturity or with significant longer-term promise are also economically evaluated. CSP combined with MED is analysed because this is one of the appointed technologies for large-scale scenarios for solar desalination. At the moment, the economic limitations of downscaling this combination are not well defined and will vary according particular site conditions. The costs of OTEC combined with RO are estimated for a closed cycle plant because OTEC is seen as a promising approach for both energy and desalination.

MD can make use of low temperature heat from solar thermal collectors and waste heat sources like CSP plants and is fairly insensitive to fluctuations in energy supply. MVC shows potential for deployment in developing regions. This is because it is tough, easy to maintain and can be mechanically coupled directly to wind turbines or PV-powered compressors. If more thoroughly researched and economically validated, HDH may also be a promising option for desalination in developing regions since it can be resilient and easy to operate and maintain.

A few other technologies not economically assessed in this study are promising for particular islands. Geothermal energy combined with desalination technologies like MED or MD has enormous potential where available. This is because its energy provision is constant and it does not require any energy storage.

Choosing the right desalination technology is not least dependent on the type of feedwater (brackish water, seawater, overall salinity etc.) and its quality. High quality feedwater from beach wells may not require any preparation when using RO technology [61]. Slightly contaminated feedwater may also be used without preparation for some thermal desalination technologies. This cuts technical complexity and investment costs. For brackish water desalination, PV-ED is a very promising and economically competitive approach. However, it is not applicable to seawater desalination today and therefore not very often deployed on small islands.

Fluctuating energy output is the major obstacle to combining wind or solar energy systems with desalination equipment. Some thermal desalination technologies can handle limited energy supply fluctuations. However, it is strongly recommended that membrane-based approaches, especially RO, are operated on a steady state basis. The use of energy storage in off-grid applications is therefore necessary at least for controlling system start-up and shutdown. Remote systems mainly supplied by renewables but also with access to external energy supplies can be considered to be run on 'fuel saver' mode. The development of RO systems for transient operation, which will significantly reduce required battery capacity and overall system costs, is the subject of R&D at different centres across the world. However, it is under investigation for seawater desalination and is not at present the most advanced system. Since transient PV-RO operation is a very promising option, particularly from the cost point of view, it is also considered for further cost calculations.

As previous studies have also shown, the costs of renewable energy desalination systems depend heavily on their location [62]. The most beneficial technology combinations identified in this study may therefore not necessarily represent the optimal solution for renewable desalination on every location on every island.

Table 8 evaluates the major technical advantages and disadvantages of different combinations of these renewable energy and desalination technologies. Different colours indicate the practical potential of different technology combinations for island renewable desalination. Fully mature combinations are shown in green. Combinations facing minor technological obstacles are shown in orange and combinations facing major technological obstacles are shown in red. The combinations shown in green, which are the most technologically mature, are well researched and have been deployed at pilot or commercial scale. These include combinations of PV, wind and CSP with RO (PV-RO, wind-RO and CSP-RO). Economic calculations of LWC in Chapter 5 therefore focus mainly on these combinations.

Table 8: Advantages and Disadvantages of Renewable/Desalination Combinations

		= Technologically mature combination		= Technologically viable combination - minor drawbacks		= Technological obstacles to be overcome/major drawbacks			
		PV		CSP		Solar thermal		Wind	
		Advantage	Disadvantage	Advantage	Disadvantage	Advantage	Disadvantage	Advantage	Disadvantage
MED				Mature technologies. Cogeneration, providing additional electricity. Promising for electricity and water provision [63] Economical in some cases with CSP-RO [64]	Fairly suitable for large-scale applications [63] Energy penalties due to heat extraction Exceeds power required to drive RO [64]	Mature technologies with good economics [42] 24 hour operation is possible with heat storage at reasonable cost Suitable for small and medium-scale plants at low temperatures [23]	More expensive than PV-RO [22] Requires almost as much electricity as PV-RO for small-scale systems [62]. Cannot compete with PV-RO from energy point of view [62]	-	-
	RO	Water cost advantage over fossil fuels [2] Components commercially available [2] Viability depends on plant capacity, distance to grid and feed concentration [3] Many pilot and commercial plants, mature technologies [2][15]	Energy storage required for energy fluctuations [60] Major problem: high initial system investment costs (CAPEX) for energy supply (PV cells) [60]	Mature technologies. Provides additional electricity Promising for electricity and water provision [63]. CSP-RO more efficient than CSP-MED [62]	Fairly suitable for large-scale applications [63]			High pressure source allows for mechanical coupling and robust flywheel energy storage [2]. Seen as one of most promising combinations, mature and proven [59, 60]. Decreasing wind turbine cost and RO component costs [59]	Fairly restricted to areas with high wind speed and high fuel prices [59]. Power variations and interruptions compromise component lifetimes [2]. High initial investment cost, energy storage system required [65].

	PV		CSP		Solar-thermal		Wind	
	Advantage	Disadvantage	Advantage	Disadvantage	Advantage	Disadvantage	Advantage	Disadvantage
ED	<p>For low salinity, energy requirements lower than RO</p> <p>Resilient and more resistant to energy fluctuations [2]</p> <p>More suitable for remote areas than RO [2] Needs DC supplied by PV</p>	<p>In seawater desalination (high total dissolved solids - TDS), higher energy requirements than RO [60]</p> <p>Capital cost up to 30% higher than diesel-ED [66]</p> <p>Not yet technologically mature for seawater desalination[60]</p>					<p>Components insensitive to wind power fluctuations [2]</p> <p>No additional energy storage required [60].</p>	<p>Hardly any pilot plants or experience yet [60].</p> <p>As ED is mostly suitable for small-scale applications, investment costs for a wind turbine might not be economically justifiable</p>
VC	<p>Mature, robust and reliable technologies [23]</p> <p>Fairly small-scale applications [62]</p> <p>Adapted MVC systems can be operated with fluctuating energy supply [59]</p>	<p>MVC significantly higher energy demand than RO [59]</p> <p>No extensive research yet [67]</p>	<p>Waste heat can be used for TVC system</p> <p>Mostly combined MED-TVC system.</p>	<p>Restricted plant capacities for CSP [23]</p> <p>No extensive research yet.</p>			<p>Direct coupling to mechanical compressor possible [43, 59].</p> <p>MVC resilient to intermittent operation, technologically mature with wind-MVC systems [59]</p> <p>Suitable for remote areas [59]</p>	<p>Few pilot plants installed [59].</p> <p>Energy consumption higher than RO [43, 59]</p> <p>High upfront costs [43]</p>

	PV		CSP		Solar-thermal		Wind	
	Advantage	Disadvantage	Advantage	Disadvantage	Advantage	Disadvantage	Advantage	Disadvantage
MD					<p>Compatible with transient nature of renewable energy source [68]</p> <p>Huge potential due to simplicity and low temperature requirements [62]</p> <p>High potential for cost reduction of MD system</p>	<p>Costly potable water production [69]</p> <p>Low recovery ratio in once through operation [62] Membranes not adapted to MD [62]</p>		
Solar Still					<p>Easy to operate and maintain, robust [3]</p> <p>Cheap materials and low investment cost [2]</p>	<p>Poor maximum efficiency at 50% (e.g. using 50% of incident radiation) [3]</p> <p>Low water productivity [3]</p> <p>Large surface area required [2]</p> <p>Susceptible to weather damage [2]</p>		
HDH					<p>Promising for small capacities (5-100 m³/day) [42, 70]</p> <p>Easy to operate and maintain, robust [70]</p>	<p>Only suitable for small capacities [70]</p> <p>HDH not yet mature [42]</p> <p>Not yet proven economical [42]</p>		

5 Economic Assessment of Renewable Desalination Options

This chapter makes an economic analysis of particular renewable desalination systems. Each system's LWC is calculated and compared with fossil-fuel systems. The cost depends on a number of parameters of which the most important are outlined below.

- System size: the larger the renewable energy system, the more electricity that can be provided by the renewable energy source, which in some cases, is cheaper than electricity from the grid. A larger desalination system also carries a lower cost due to economies of scale.
- Resource quality: the higher the annual irradiation, the more PV and CSP LCOE decreases. The higher the wind speed, the more wind energy LCOE decreases. In either case, desalination plant operating costs are reduced, lowering the cost of water.
- Cost of capital: higher water costs and a higher WACC both increase the cost of financing.
- Backup power: water costs rise with the costs of electricity provided by the grid.

In this report, the costs of water are assessed according to the parameters listed for the following system types:

- grid-connected PV-RO (grid serves as backup)
- off-grid PV-RO with battery (24 hour operation)
- off-grid PV-RO with small backup battery for 7 hour operation
- CSP-RO
- CSP-MED
- grid-connected wind-RO (grid serves as backup)
- off-grid wind-RO (discontinuous operation)

The source of energy is either electricity through PV, wind and CSP or heat through CSP. Therefore, either LCOE or the levelised cost of heat is considered in the water costs. The main parameters for the desalination plant cost calculations are described in Tables 5 and 6 in Chapter 2.

5.1 Cost of Water from Reverse Osmosis Desalination with Photovoltaics

Water production costs on islands through conventional RO are at around 1.6-3.3 USD/m³ assuming electricity costs at 0.2-0.5 USD/kWh. The calculations in this chapter show the comparative costs of water for RO powered by PV, and use the technical and economic characteristics of a PV reference plant outlined in Table 9.

Table 9: Data to Calculate the Levelised Cost of Electricity from PV Plants

	Unit	Value	Reference
Specific CAPEX	USD/kWp*	1,470	[29]
OPEX	USD/kWp	40	[29]
Global horizontal irradiance	kWh/m ² /year	2,000	Assumption
PV energy yield	kWh/kWp/a	1,500	[71]
Lifetime	years	30	[29,39]
Inverter overhaul cost	% of CAPEX after 12 and 24 years	15	[29]
WACC	%	5;10	Assumption

*kilowatt-peak

See Kost, *et al.* [29], for the calculation method for PV LCOE. Based on the assumptions in Table 9. The LCOE for PV systems is 0.11 USD/kWh at a WACC of 5% and 0.15 USD/kWh at a WACC of 10%. For the PV-RO system, both grid-connected and off-grid desalination are investigated.

Grid-connected Photovoltaic Systems for Reverse Osmosis

Calculations for a grid-connected system assume that seven hours of solar radiation are available at most. If the PV system is large enough to produce all the energy needed for the RO process during these seven hours, the PV can provide around 30% of the RO energy, and remaining energy demand will be purchased from the grid. Thus, the PV share is about 30% for a grid-connected desalination system.

The cost of electricity is calculated as a weighted average of electricity costs from PV and the grid. LCOE is assumed at 0.11-0.15 USD/kWh for PV and 0.2-0.5 USD/kWh on the grid. The resulting energy cost for RO plants is 0.18-0.4 USD/kWh (Table 10). Since grid electricity costs more than PV electricity, a smaller PV system size increases the cost of water.

Table 10: Composition of the Cost of Electricity for Reverse Osmosis plants

	Unit	Value
PV share	%	29
LCOE PV	USD/kWh	0.11-0.15
Grid electricity share	%	71
Grid electricity cost	USD/kWh	0.2-0.5
Cost of electricity for RO plant	USD/kWh	0.18-0.4

Figure 16 shows the LWC for a PV-RO plant with a WACC of 5% and 10%, depending on the cost of electricity supply from the grid. The higher the WACC and the smaller the RO desalination plant, the higher the cost of water. The cost of electricity supplied from the grid as backup for the PV system has the greatest influence on the water cost, as indicated on the x-axis of Figure 16.

Figure 16: LWC for Grid-connected PV-RO Plants Producing 250-2,000 m³/day at a Global Horizontal Irradiance of 2,000 kWh/m²/year

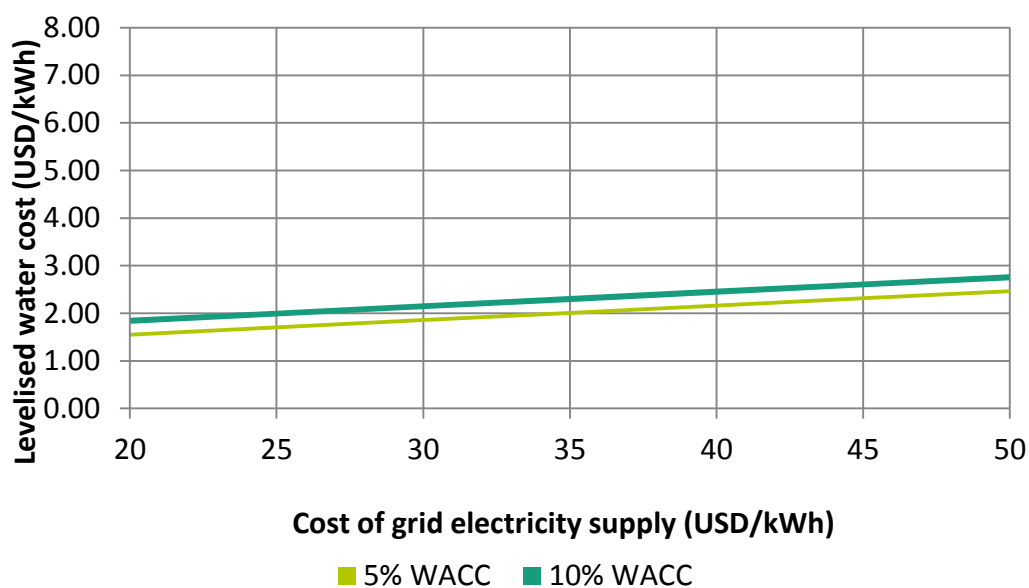

The cost of PV-RO desalinated water with the listed assumptions is 1.5-2.5 USD/m³ with a 5% WACC and 1.8-2.8 USD/m³ with a 10% WACC.

This calculation assumes that PV electricity is fully consumed by the RO desalination plant. Another option would be to enlarge the PV system and provide electricity to the grid when more electricity is produced than can be consumed by the desalination plant. In that case, a higher electricity share could be used for the desalination plant’s own consumption. Since PV electricity is cheaper than grid electricity, this would cut the cost of the PV-RO system. Surplus PV electricity sold to the grid would make the investment even more attractive.

Off-grid Photovoltaic Systems for Reverse Osmosis

Two options ensure an off-grid PV-RO system provides enough water. The first is to use batteries to store PV electricity, allowing the RO desalination unit to operate at full load 24 hours a day. The second option is to operate the system only when the sun is shining and the PV modules supply energy. In this case, a larger desalination unit is needed to provide the same amount of desalinated water, and a water storage tank must be installed. Water is desalinated when PV energy is available and delivered to the storage tank for later use. In this case, the RO unit needs to be operated flexibly. Flexible RO plants are still under development, and their costs are analysed here on the assumption that they will be commercially available in the near future.

In an off-grid PV-RO system without batteries, the PV system is assumed to provide electricity to the RO plant for seven hours a day. To produce 250 m³ of water each day during these seven hours, the RO plant needs to have a daily capacity of 857 m³/day. Table 11 shows the assumptions used to calculate LWC for the RO system operating 24 hours a day with battery and seven hours a day without battery.

Table 11: PV-RO Systems Data Operating 7 Hours and 24 Hours per Day

	Unit	24 hour system	7 hour system
RO capacity	m ³ /day	250	857
Specific RO CAPEX	USD/m ³ /day	2,320	2,090
RO CAPEX	USD	580,000	1,791,130
PV capacity	kWp	243	230
Specific PV CAPEX	USD/kWp	1,470	1,470
PV CAPEX	USD	357,210	338,100
Battery capacity	kWh	180	-
Cost of energy storage	USD/kWh	1.50 [2]	
Share of energy stored in	%	63	
Average cost of electricity for RO plant	USD/kWh	1.06-1.1	0.11-0.15

The energy stored in the battery is reduced due to losses during storage. In the 24-hour operation case, which requires a battery, PV capacity needs to be larger to make up for the storage losses. The cost of storage is included in the calculation as follows: in addition to LCOE, each kWh stored in the battery is charged with the cost of energy storage. This results in an average electricity cost of 1.06-1.1 USD/kWh for a 24-hour system and 0.11-0.15 USD/kWh for a seven-hour system.

Figure shows the cost of water from an off-grid PV-RO system operating seven and 24 hours/day. For seven-hour operations, the cost of water is 2.3 USD/m³ with a 5% WACC and 3.3 USD/m³ with a 10% WACC. For 24-hour operations, the cost of water is 5.4 USD/m³ with a WACC of 5% and 5.80 USD/m³ with a WACC of 10%. The water cost for the 24-hour plant is higher due to the battery capital and operating costs as well as a higher capital cost for the larger PV plant required. As already noted, the cheaper discontinuous operation is not yet commercially available.

Figure 17: LWC for PV-RO Systems Running 7 and 24 hours/day with Annual Global Horizontal Irradiance of 2,000 kWh/m² and WACC at 5% - 10%

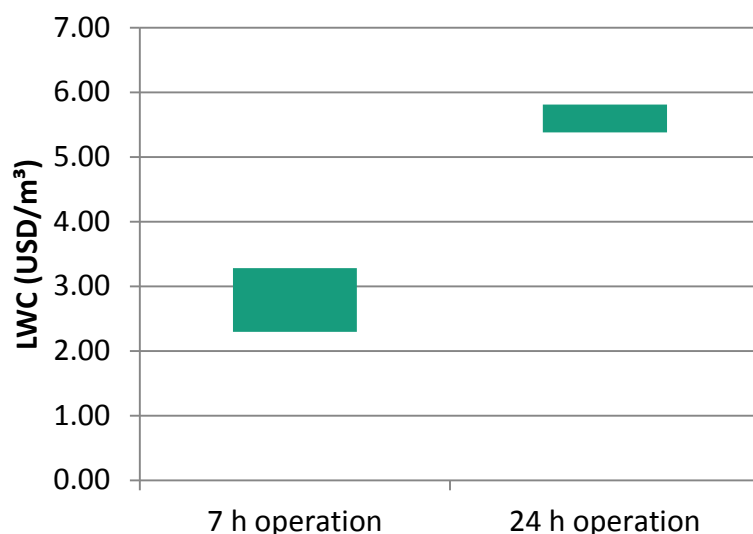

5.2 Reverse Osmosis Desalination with Concentrated Solar Power

RO desalination can be powered using a CSP plant. An energy storage tank allows the CSP plant to provide electricity night and day. The collector field is then larger than that of a power plant without storage. During the day, energy from the solar field is used to operate the power block, and surplus energy is stored in the heat storage tank. At night, the CSP plant can then be operated using heat released from the storage tank. At present, the largest tanks provide 15 hours of storage, allowing the desalination plant to operate 22 hours/day Table 12 shows the parameters assumed for LCOE from CSP.

Table 12: Data for Calculating Levelised Cost of Electricity from CSP plants

	Unit	Value	Reference
Specific CAPEX	USD/kW	9,960	[29]
OPEX	USD/kWh	0.038	[29]
Direct Normal Irradiation	kWh/m ² /year	2,000-2,500	assumption
Lifetime	years	25	[29,39]
WACC	%	5; 10	[40]

For the LCOE calculation method see [29]. Using the values defined in Table 12. The LCOE from CSP plants is 0.32-0.39 USD/kWh with a 5% WACC and 0.48-0.59 USD/kWh with a 10% WACC. In addition, Table 13 describes the CSP input parameters for the RO plant in the cost calculation.

Table 13: Data for Calculating Water Costs from CSP-Driven RO Desalination Systems

	Unit	Value
Resulting cost of electricity at 5% WACC	USD/kWh	0.32-0.39
Resulting cost of electricity at 10% WACC	USD/kWh	0.48-0.59

Figure 18 shows LWC for a CSP-RO plant with varying levels of direct normal irradiance at two different costs of capital. The cost of water is 2.2-2.6 USD/m³ with a 5% WACC and 2.9-3.4 USD/m³ with a 10% WACC.

Figure 18: Levelised Cost of Water for CSP-RO plant

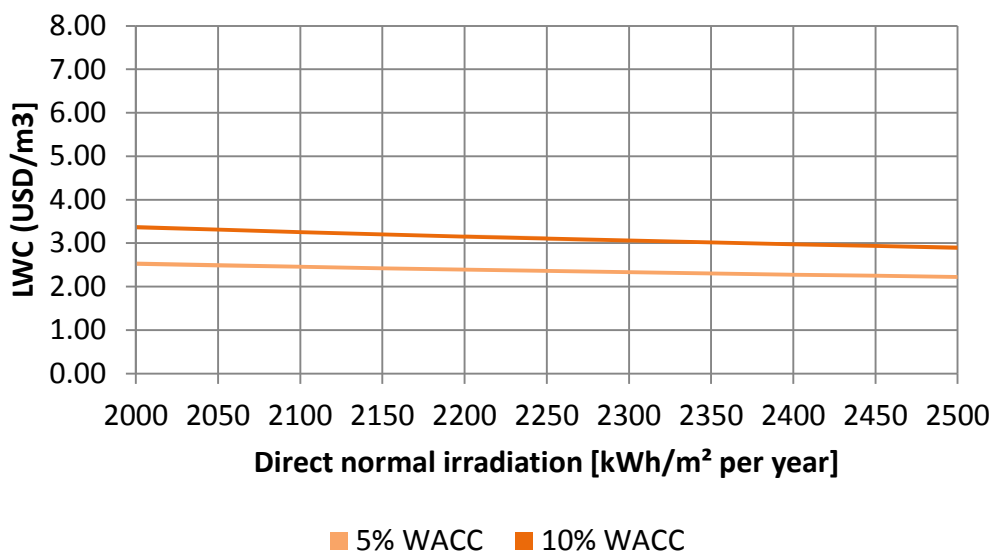

5.3 Multi-effect Distillation with Concentrated Solar Power

CSP power plants convert heat into electricity, which can be used for desalination as described above. Alternatively, the heat from the solar field can be used for thermal water desalination. In this case, the CSP plant design is simpler since no power block or electricity conversion equipment is installed. The investment and operating costs of a CSP heat plant are thus lower than a CSP-RO combination.

LWC for the CSP-MED combination is determined by calculating the levelised cost of heat from the CSP plant. The calculation is comparable to the LCOE calculation described in [3]. Table 14 presents the main input parameters for the levelised cost of heat from a CSP plant.

Table 14: Data for Calculating the Levelised Cost of Heat from CSP Plants

	Unit	Value	Reference
Specific CAPEX	USD/kW	4,450	[29]
OPEX	USD/kWh	0.019	assumption
Direct normal irradiation	kWh/m ² /year	2,000-2,500	assumption
Lifetime	Years	25	[29,39]
WACC	%	5;10	[40]

Using the parameters described, the levelised cost of heat is 0.06-0.08 USD/kWh with a 5% WACC and 0.09-0.11 USD/kWh with a 10% WACC. LWC water from the MED plant is calculated using the input parameters described in Table 12.

LWC of a CSP-MED plant depends on solar irradiation as well as WACC is shown in Figure 19. The width of the band is explained by the range of assumed grid electricity costs: the upper limit of each band represents a higher electricity cost and the lower limit a lower electricity cost.

Figure 19: Levelised Cost of Water for a CSP-MED System with 15 hours of Storage

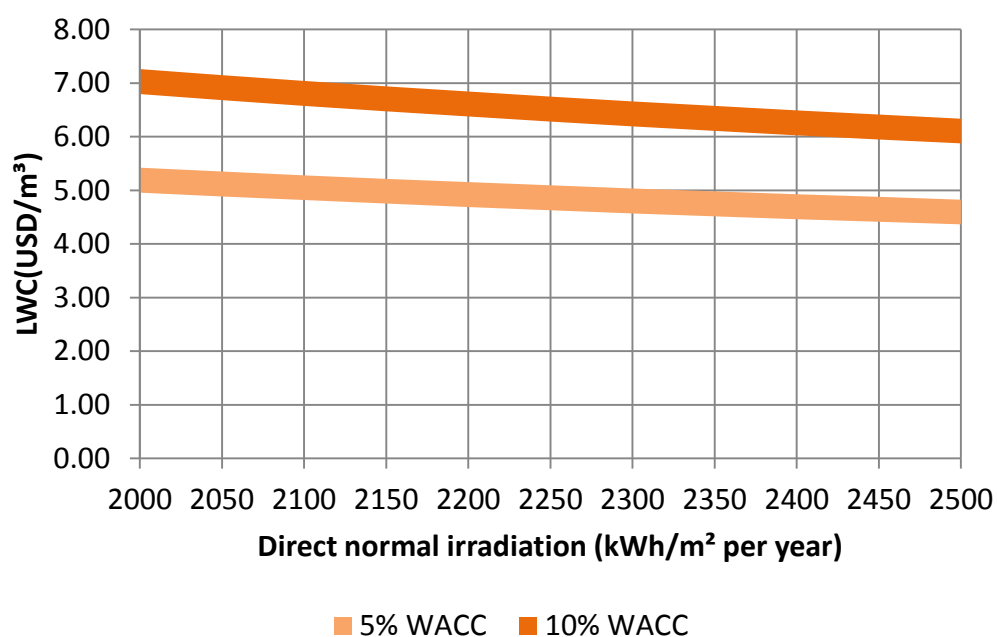

At a high irradiation level of 2,500 kWh/m²/year, the cost of water for the CSP-MED plant is 4.4-4.8 USD/m³ with a 5% WACC and 5.9-6.3 USD/m³ with a 10% WACC depending on the cost of electricity from the grid. At a low irradiation of 2,000 kWh/m²/year, the cost of water is 5.0-5.4 USD/m³ with a 5% WACC and 6.8-7.3 USD/m³ with a 10% WACC. As can be seen from the graph, the cost of water from a CSP-MED system is highly dependent on the level of solar irradiation.

5.4 Reverse Osmosis with Wind

Grid-connected wind power plants can be combined with RO desalination, in which case the grid serves as backup when no wind energy is available. Alternatively, this can work as an off-grid system, in which case batteries or flywheels are used for energy storage.

Table 15: Wind Energy Data to Calculate Levelised Costs of Electricity

	Unit	Value	References
Specific CAPEX 45 kW turbine	USD/kW	3,890	[72]
Specific CAPEX 100 kW turbine	USD/kW	2,660	[72]
Specific OPEX 45 kW turbine	USD/kW/year	329	[72]
Specific OPEX 100 kW turbine	USD/kW/year	147	[72]
Full load hours	h/a	1,000-2,000	[72]
Lifetime	years	20	[73]
WACC	%	5;10	[40]

For the LCOE calculation method see [29]. Based on the assumptions listed in Table 15, wind energy LCOE is 0.32-0.8 USD/kWh for a 45 kW wind turbine and 0.18-0.46 USD/kWh for a 100 kW wind turbine, depending on WACC. LWC is calculated on the basis of assumptions defined in Table 5. The analysis has considered both grid-connected and off-grid water desalination for wind-RO.

Grid-connected wind energy for reverse osmosis

Grid-connected wind energy is assumed to have sufficient capacity to run the desalination plant at full load. This ensures the RO plant can consume any surplus energy delivered by the wind turbine(s). The capacity of the wind turbine is then around 45 kW for an RO plant size of 250 m³/day. This capacity of wind turbine is not very common on the international market, which usually starts at above 1,000 kW. On the other hand, small wind turbines for households or small businesses are available at up to around 100 kW. However, this market is still very small and has not yet entered mass production (Bundesverband Kleinwindanlagen). This means small wind turbines for island desalination systems cost much more per kilowatt of capacity than conventional wind turbines on the market.

Wind speeds increase exponentially with larger hub heights. Wind turbines below 100 kW have low hub heights of less than 50 metres. At this height, low wind speeds limit generation to 1,000-2,000 full load hours per year [72]. Along with the higher investment cost per kilowatt, this restricted output makes LCOE substantially higher for small wind turbines than for standard systems.

This case study examines RO desalination plants of 250 m³/day fitted with a 45 kW wind turbine. With full load hours of 1,000-2,000 hours per year, 12%-24% of the electricity required by the RO plant can be supplied by wind energy. The remaining energy is supplied by the grid, therefore LWC is highly dependent on the grid electricity price

LWC is calculated on the basis of the assumptions defined in Table 5. Figure 20 shows LWC for wind-RO plants at varying costs of grid electricity and capital. At a grid electricity cost of 0.2 USD/kWh, LWC is 1.8-1.9 USD/m³ with a 5% WACC and 2.2-2.3 USD/m³ with a 10% WACC. With rising grid electricity prices, LWC increases to 2.8-3.0 USD/m³ with a 5% WACC and 3.1-3.4 USD/m³ with a 10% WACC.

Figure 20: Levelised Cost of Water for Wind-RO Plant Producing 250 m³/day

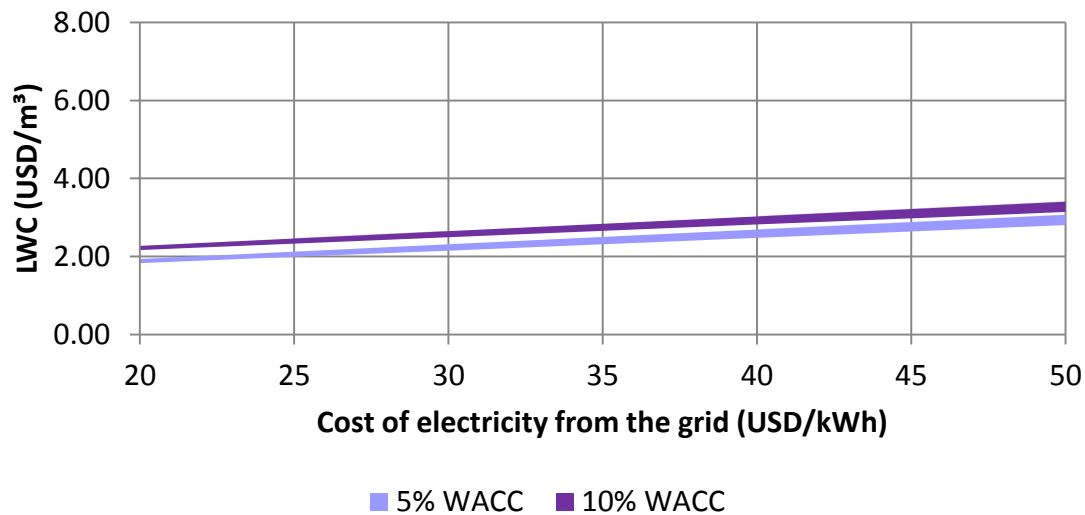

Off-grid Wind Energy for Reverse Osmosis

Off-grid wind-RO can be operated either with or without a battery system. The battery-coupled system can provide the desalination plant with a constant amount of electricity to make continuous operation possible. But the optimum sizing of the wind turbine, desalination system and battery banks depends on the wind profile, which relies on the system location. This means the cost is equally dependent on the location. Thus no general water cost calculations for off-grid wind-RO containing a battery can be presented in this study.

This section hence focuses on wind-RO systems without batteries. This kind of operation is still at research stage since discontinuous operation of RO plants has not yet been validated in long-term system tests. However, it is assumed that this technology will be available on the market in the short to medium term. The cost of water for the off-grid wind-RO plant is calculated on the basis of the specific data for wind-RO described in Table 16 and the general information outlined in Table 5.

Table 16: Main Input Parameters for Levelised Water Costs for Wind-RO Systems

	Unit	Value	Reference
RO plant output	m ³ /day	250	[38]
RO capacity	m ³ /day	1,010-2,190	
Specific RO CAPEX	USD/m ³ /day	2,320	[38]
Wind full load hours	-	1,000-2,000	[72]
Wind LCOE	USD/kWh	18-46	

A larger wind turbine size is assumed for LCOE than in the grid-connected case. RO capacity of 1,010-2,190 m³/day necessitates 180-400 kW of wind power. It is assumed that this power is provided by two to four 100 kW wind turbines. LCOE is 0.18-0.46 USD/kWh for a 100 kW wind turbine, depending on WACC. The size of the RO plant depends on the full load hours of the wind turbine. To obtain 250 m³/day, the RO plant needs to have a capacity of 1,100 m³/day with 2,000 wind turbine full load hours per year or a capacity of 2,190 m³/day with 1,000 wind turbine full load hours per year.

LWC for off-grid wind-RO for varying amounts of annual wind output and at different costs of capital is shown in Figure 21. Where low wind speeds allow the wind turbine just 1,000 full load hours, LWC is 5.4 USD/m³ with a 5% WACC and about 7.7 USD/m³ with a 10% WACC. For locations with high wind speeds resulting in 2,000 full load hours, LWC is 3.0 USD/m³ with a 5% WACC and about 4.2 USD/m³ with a 10% WACC. The graph below shows that LWC is strongly dependent on the wind turbine output and location. This technology is still at the research stage and not yet commercial.

Figure 21: Levelised Cost of Water for Off-grid Wind-RO Producing 250 m³ of water/year

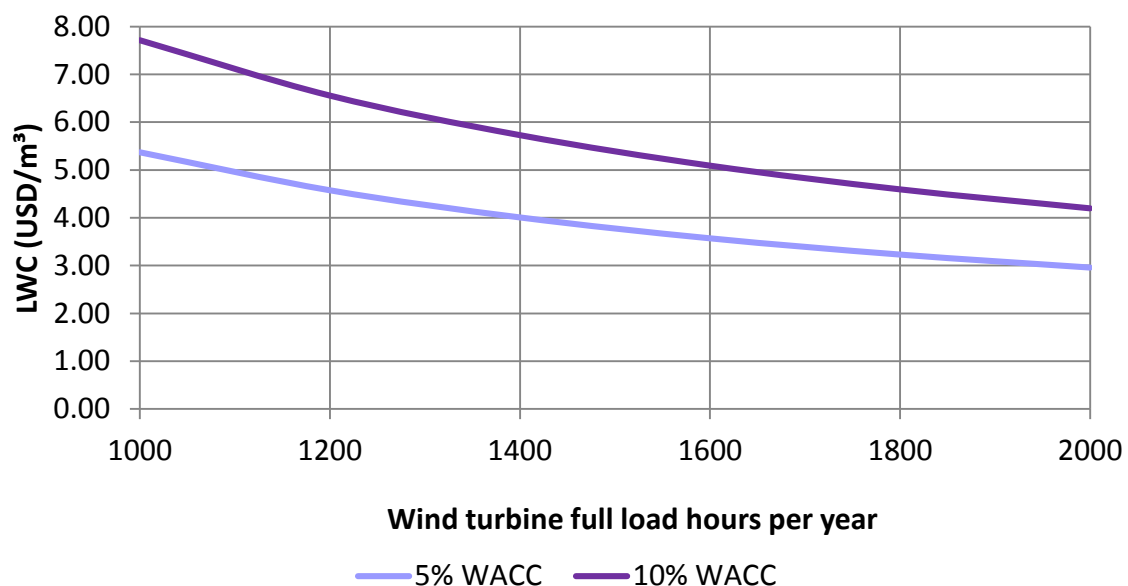

5.5 Comparison of Water Costs for Different Renewable Desalination Technology Pairs

An overview of LWC for the different technology combinations on islands is shown in Figure 22. The costs of fossil-fuel desalination plants are displayed in blue bars and renewable desalination plants in pale green. Renewable desalination with grid backup is shown in dark green. Continuous CSP-MED is an exception and uses heat from the CSP plant but electricity from the grid. However, its electricity demand is much lower than the thermal energy provided by the CSP plant. CSP-MED is thus viewed as a fully renewable desalination option.

Figure 22: Levelised Cost of Water for Different Renewable Desalination Technologies on Islands*

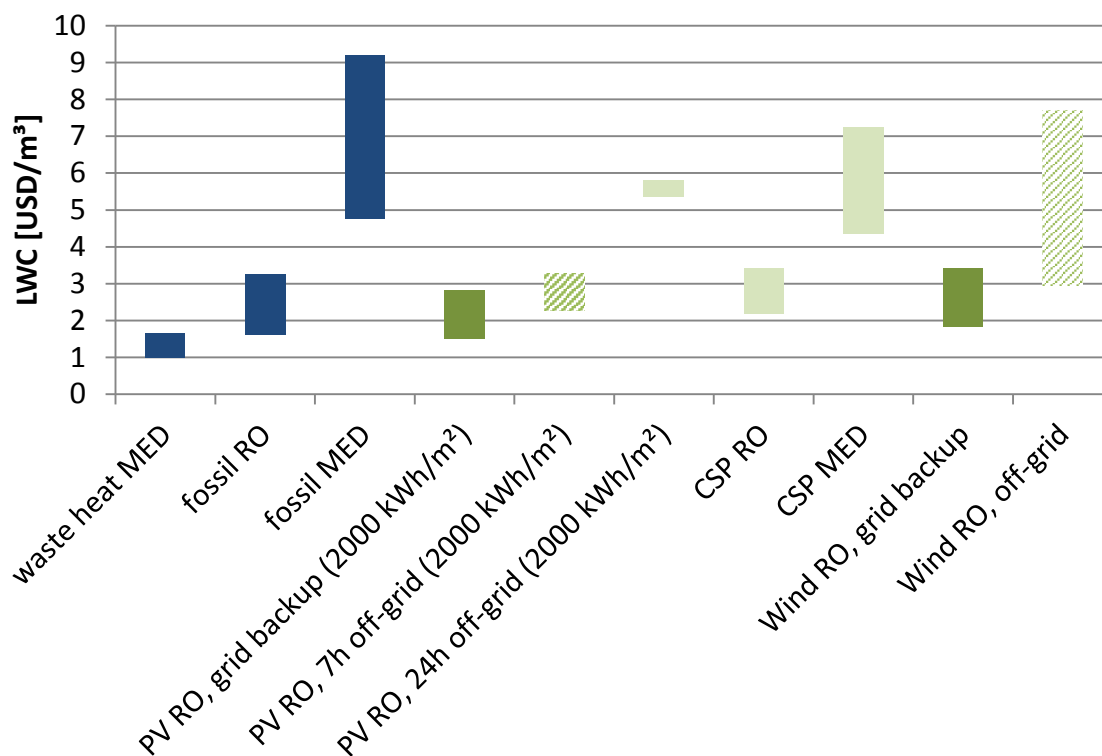

*technologies still at research stage are **shown** hatched

Comparing all the analysed fossil-fuel and renewable desalination options, it can be seen that waste heat-MED is the most economical option with a cost starting at 1 USD/m³. This assumes the energy source is free of charge, which is possible when waste heat from electricity generation is a non-usable by-product that can be used to desalinate water. In that case, the fuel costs are assigned to electricity production and the waste heat is free of charge.

Where the power plant produces electricity, and waste heat is used to desalinate water, fuel cost allocation determines the cost of both products. The fuel cost may be fully assigned to electricity production, in which case fuel for MED desalination is free of charge and the cost of water is low. Alternatively, the fuel cost could be fully assigned to the desalination unit, in which case the cost of electricity would be very low. In most cases, the cost of water excludes the cost of energy. This makes the cost of fossil-fuel MED appear low. It is therefore important to keep in mind that the real cost of desalinating water may be higher.

If the MED process is run from a fossil-fuel heat plant, the cost is much higher than when it runs on waste heat, ranging at 4.8-9.2 USD/m³. The cost of fossil-fuel-RO desalination lies between low and high-cost MED options at around 1.6-3.3 USD/m³.

Grid-connected PV-RO is at present the most cost-effective option for renewable desalination. At an irradiation of 2,000 kWh/m², the cost of grid-connected PV-RO desalination is 1.5-2.8 USD/m³. This cost is competitive with fossil-fuel-RO. The PV system is used as an energy source for about 30% of the system's electricity demand, and the remaining energy is retrieved from the grid.

If the desalination plant is to produce the same amount of water through stand-alone PV, the cost rises to 2.3-3 USD/m³ for a plant without electricity storage operating only seven hours/day. It

rises to 5.4-5.8 USD/m³ for a continuous plant including electricity storage. PV off-grid desalination without electricity storage is still at research status.

It is cheaper to couple a CSP plant to RO than to MED. The cost of CSP-RO desalination is 2.2-3.4 USD/m³, which is comparable to the cost of fossil-fuel-RO. For CSP-MED desalination, the cost is higher at 4.4-7.3 USD/m³. If the CSP system is used for electricity production, and the MED plant is run from CSP waste heat, the investment cost for the CSP plant is assigned to the cost of electricity. This means the cost of desalinated MED water is 1-1.6 USD/m³, exactly the same as fossil-fuel-MED.

Wind power desalination with grid backup costs 1.8-3.4 USD/m³. This is comparable to fossil-fuel-RO desalination. If the wind desalination uses an off-grid system, the cost depends very much on the wind profile and therefore location, but typically stands at 3-7.7 USD/m³. Off-grid wind desalination without electricity storage is still at research status.

To summarise, renewable desalination on islands can be cost-competitive with fossil-fuel desalination, depending on the location of the resources and cost of fossil fuel on the island. The cost of water can be reduced by RO and MED systems run by PV and CSP, as well as by RO systems driven by wind. Where grids are available, installing renewable energy systems to reduce the amount of fossil-fuel grid electricity required for desalination may also be economically attractive.

6 Barriers to Island Renewable Desalination

6.1 Barriers and Drivers

Many types of renewable desalination systems have shown their commercial or technological feasibility as pilot plants, but a variety of barriers to wider deployment need to be overcome. These barriers consist of materials and component resilience, preparation requirement, post-treatment and maintenance, grid implementation issues and associated costs. An overview of relevant barriers and drivers is provided in the following sections.

Materials and component resilience

Desalination technologies based on membranes face major barriers concerning their resilience, scaling and fouling as well as consistently high water permeation rates. A great deal of research has been conducted in recent years. New membrane materials may show less fouling tendency alongside increased resistance to intermittent renewable source characteristics and resulting pressure fluctuations. They extend membrane lifetime, increase the recovery ratio and salt rejection and provide higher water permeate flow [74]. Many membrane manufacturers predict membrane price increases because profit margins have been comparatively low in recent years and technology improvements and competition are not expected to keep prices at low levels [74].

Aggressive saline waters at elevated temperatures mean thermal desalination systems require materials like stainless steel resistant to corrosion. Since such materials require higher initial investment they tend to be more competitive in larger-scale systems. The development and choice of appropriate materials goes hand in hand with minimal maintenance demand and operating expenses. Resistant and enduring materials are an important way to increase system durability and may reduce investment requirements by averting the need for energy storage, especially in very remote regions.

Preparation and post-treatment

Preparation requirements for desalination systems depend greatly on feedwater quality and thus plant and feedwater intake location. Preparation is essential to protect the desalination unit from fouling and scaling. In some locations, membrane-based preparation technologies such as ultrafiltration may not be possible due to excessive turbidity or algae content, for example. Chemicals such as chlorine may need to be added, PH value adjusted or coagulation/flocculation agents introduced. When bare filtration-based preparation is not viable, maintenance demand will be significantly higher. This is because the chemicals required have to be brought to the desalination plant on a regular basis. Furthermore, better trained operating personnel and a wider operating strategy are required. The use of chemicals can also have a negative influence on ecosystems, which can be particularly sensitive on islands. Brine disposal can therefore be a critical barrier to operating desalination systems particularly at inland locations but also at sensible

coastal sites. The same issues can come up for post-treatment if desalinated water is to be stored or distributed through distribution networks, as lasting disinfection by chemicals may become necessary.

Maintenance requirements

Maintenance needs and costs are affected by system maturity, resilience, material durability and the need for preparation or post-treatment. The less technologically complex the system, the more easily and cheaply it can be maintained and the less effort needs to be put into training O&M staff. Thus, extensive and complex preparation or post-treatment should be avoided, as well as highly complex or immature technological approaches.

Desalination technologies like RO or MED have been deployed for years. A great deal of R&D has been conducted on these technologies and a vast amount of experience gathered. Thus, they could allow minimal maintenance demand and long system lifetimes. In general, RO systems are less likely to malfunction than are MED and MSF. A certain number of membrane replacements are usually required during the RO system lifetime depending on raw water conditions, quality of preparation and appropriateness of operational parameters.

Technology improvements

Several renewable desalination options are expensive, and this may be considered a barrier to market expansion. However, R&D efforts could serve as a market driver by reducing costs and improving reliability, making new additional options feasible and present feasible options more attractive.

- RO systems could be introduced as flexible load in existing (micro) grids, increasing grid stability and making such systems more attractive to investors and energy companies.
- Technological approaches for refilling overexploited groundwater lenses or aquifers with excess desalinated water could make desalination systems more attractive in some locations. It could allow seasonal storage on islands with fluctuating tourist arrivals and boost desalination capacities, resulting in a lower LWC despite higher initial investment requirements.

Economic factors

Some renewable desalination systems are very costly, and economic factors have a major impact on their expanded application. As shown in previous chapters, several of these systems are already cost-competitive on islands with high energy costs and good solar or wind resources. As the costs of renewable energy and desalination technologies decline and fossil energy costs increase over time, the economic pay-off from investing in renewable desalination on islands is likely to rise.

The cost of energy storage is a major barrier to renewable desalination deployment on smaller island power grids. On islands with no substantial grid, conventional desalination approaches that do not require energy storage may be the least-cost option unless the costs of energy storage decline significantly in coming years. Mechanical (and thus resilient and cheap) short-term energy storage systems like flywheels may mature technically, and this could provide one solution to energy storage.

Materials impose a major cost barrier, especially for thermal systems requiring high-grade steel. All desalination systems are more cost-competitive when greater in size [74], and this especially applies to thermal systems and should preferably use cost-free waste heat.

Bognar [49] states that barriers of a technological nature and high power or water costs hardly ever obstruct the wider use of renewable desalination. Instead, barriers arise from high initial investment costs, political and administrative issues. The World Health Organisation states that just one US dollar invested in water supply and sanitation may yield a return of USD 2.8 for a developed country and USD 6 for a developing country [75]. Focusing on the long-term economic prospects and ecological benefits emerging from investment in renewable water treatment and sanitation systems is therefore of utmost importance.

Financing

More governments delegate water supply to independent water and power producers in the private sector. Water supply projects may also be delivered using the Build-Own-Operate (BOO) or Build-Own-Operate Transfer (BOOT) model [74]. The private sector delivers about three fifths of all new water projects, of which around half are financed by independent water and power producers and half through the BOOT approach [38].

BOO delivery means long-term contracts are arranged between supplier and client and the client pays for water and energy provided [74]. BOO contracts are thus sensitive to the prevailing total water cost [74]. BOOT contracts are similar, but the project is transferred to the client later on. The BOOT approach is seen to offer advantages such as best value for money to the client, risk distribution between several parties and attractive off-balance sheet finance for municipal water authorities [38]. But BOOT contract drawbacks include lower plant residual value, higher cost compared to public finance in some countries, the need to establish offtaker creditworthiness and relatively high complexity. This leads to comparatively high unit costs for smaller-scale projects [38, 74].

Desalination plants in low income countries are mostly financed by subsidising domestic customers through higher rates for industrial customers [38]. Payments by customers often do not cover return on capital investment. Many municipal water utilities have low credit ratings, so that they cannot act as counter-party to BOOT contracts [38]. Desalination finance may thus come from international development banks or other development partners [38]. Credit support instruments are also being introduced, allowing syndication funding through several banks and institutions [38].

Islands with mature desalination infrastructure (such as Antigua or Cabo Verde) are most likely to permit access to desalination equipment, and the obstacles to deploying renewable desalination systems are likely to be manageable. Trained O&M personnel, financing strategies, public as well as private water service providers will already be available and known.

The reverse is true for islands lacking or about to install desalination systems. They will find it difficult to provide well trained O&M personnel, maintain or even introduce municipal water providers or grant access to appropriate water supply companies. Such islands may seek private companies to build their desalination plants, applying elaborate credit support instruments to provide a return on capital investment and cover O&M costs.

6.2 Availability of Desalination Systems, Suppliers and Operators

Table 17 provides a partial overview of companies with experience of constructing and installing renewable desalination systems. More information on other entities is also available with the International Desalination Association (IDA) that provides expertise on desalination and water reuse.

Table 17: Summary of Companies with Experience of Solar Desalination:
a) Suppliers of PV-RO Desalination

Company	Technology	URL	Comment
Hitachi Plant Technologies (HPT)	PV-RO	www.hitachi.com/businesses/infrastructure/index.html	Experience in Vanuatu (Eastern Ambae island and Aniwa island), Tuvalu (Funafuti, Tuvalu, outer Islands, Palau (Peleliu), Nauru)
Hitachi-Aquatech	PV-RO	www.hitachi-aqt.com	Experience of PV-RO
Toyota Tsusho Corporation, Toray Industries	PV-RO	www.toray.com/	Republic of Marshall islands - 15 schools in 15 outer island communities
Trunz	PV-RO	www.trunzwatersystems.com	Compact systems; PV-battery energy supply; RO components from Sectrawatermaker.
Kary PlanAqua	PV-RO	www.kary-planaqua.de/	Experience with PV BW-RO
	PV-RO	www.elementalwatermakers.com	Compact PV-RO systems
IBM	CPV-RO	http://researcher.watson.ibm.com/researcher/view_group.php?id=3539	CPV-RO; innovative components, project with Saudi Arabia KACST appears to have stalled
Spectra Watermaker	(PV-)RO	www.spectrawatermakers.com	Compact RO and ERD technology for PV-RO systems.
SwissInso	PV-RO	www.swissinso.com	Launched a PV-RO container solution in 2011 for 50 m ³ /day -no longer promoted

b) Solar Thermal Desalination Suppliers

Company	Technology	URL	Comment
TerraWater	Solar thermal HDH	www.terrawater.de	Modular systems; one product combined with solar thermal collectors
MemSys	Solar thermal and waste heat MD	www.memsys.sg	Only module producer, but with references in solar thermal systems
Aquaver	Solar thermal and waste heat MD	www.aquaver.com	Partner from MemSys realising solar-MD systems
SolarSpring	Solar thermal MD	www.solarspring.de	Solar-MD systems; Fraunhofer ISE spin-out

c) Major suppliers of other renewable desalination

Company	Technology	URL	Comment
General Electric	Several	www.gewater.com	Important player conducting research in solar desalination
DecRen Water Consult	Consultant	www.dwc-water.com	Consultant specialised in decentralised and integrated solutions powered by renewable energy for the whole water sector
Fichtner	Consultant	www.fichtner.de/en/home/	Experience of CSP-MED combinations

Capacity-building Needs

High initial investment can impose a major barrier to economies without the necessary financial means. However, staff recruitment and training is the next greatest concern affecting the sustained deployment of renewable desalination. As Genthner [76] states, advances in desalination are unlikely to be achieved through groundbreaking technical approaches but rather through multidisciplinary optimisation and capacity building.

Education

Training may take place at a university or central training institution through frequent local workshops [77]. These training centres may first have to be set up in certain regions. Local island state unions and organisations exist already (such as CARICOM, SPC, AOSIS) and can establish training programmes to minimise the efforts of each individual island state [76].

Including hands-on experience and workshops is always beneficial, especially given the rather weak basic education of staff to be trained. Training material and the language spoken should be appropriate to the capabilities and education of the personnel involved [77]. Including long-

established local inhabitants in education and training programmes will be one way to foster acceptance of the technology within the population. Local manufacturing of system components is another. In addition to technical staff training, education schemes for management planning and human resources need to be considered [76].

O&M or human resource training is not enough, however. Educational capacity building needs to begin at primary school level and follow through to the tertiary sector. Schools provide the basic education needed to train qualified staff later on, as well as to motivate students to pursue higher education.

University programmes and lectures about desalination and renewable energy at local institutions may yield long-term benefits by providing educated personnel and thus a long-term basis for the system's existence [78]. Well trained academic staff may, for example, act as contacts for issues that may arise at a later date concerning the establishment and maintenance of renewable desalination plants. Water safety plan implementation, as proposed by the World Health Organisation, requires the necessary personnel to have the appropriate education [79].

Renewable energy desalination systems will not be successful unless people's concerns about water (e.g. taste or smell) as well as about the technologies themselves (appearance of solar collectors or wind turbines) are addressed and eliminated. The education of young students as well as old people about basic issues like water quality and the rational usage of water is one essential capacity-building means ensuring desalination systems are sustained. Older citizens need to be given information about water quality and desalinated water. Easily readable pamphlets or regular local workshops will fulfil this task or integrating public awareness activities with ongoing island communities activities. Students can be educated through schools or local clubs, community centres or similar organisations.

Information Availability

In a digitised environment, a large share of people have access to the internet, so comprehensive databases can minimise educational needs and improve quick and cheap problem solving. This applies to technical staff, enabling them to access data through search engines or by seeking answers to specific questions. Technical and operational problems with renewable desalination systems could be documented and made accessible to all staff. This would minimise local requirements for highly educated academic personnel and would avoid prolonged system downtime. Publicly available information and educational material could also be used to inform the public about renewable desalination systems. It could minimise islands concerns about the health implications of desalinated water, for instance.

These types of approaches could be managed through centralised institutions. However, more traditional approaches will still be needed such as handbooks on how to handle major operational issues. Modern information technology like cellphone networks and satellites could also allow automatised data transmission and system monitoring by a pool of central operating staff or health inspectors [79]. This approach could be a particularly appropriate option for very remote islands lacking a sufficient corps of maintenance personnel or with very low educational levels.

Networks and Organisations Supporting Renewable Energy Desalination

Table 18 provides a partial overview of different organisations contributing to renewable desalination by funding R&D or through public information campaigns such as lobbying and conferences.

Table 18: Networks and Organisations Supporting Renewable Desalination:

Name and URL	Members
European Desalination Society www.edsoc.com	Companies, R&D centres, private individuals
European Innovation Partnership on Water – with different action groups Renewable Energy Desalination www.eip-water.eu/working-groups/renewable-energy-desalination-ag025	Abengoa Water SLU, Agricultural University of Athens, Aquaver, Aston University, Centro de Investigaciones Energéticas, Medioambientales y Tecnológicas, Centre for Renewable Energy Sources and Saving, D & R Globe Elemental Water Makers, European Desalination Society, Fraunhofer ISE, ITC (Instituto Tecnológico de Canarias SA), SolarSpring, Technische Universität München, Trunz Water Systems University of Evora, Università Degli Studi di Palermo, Wirtschaft und Infrastruktur & Co Planungs-KG
Prodes Project www.prodes-project.org	Germany: Fraunhofer ISE, Gesellschaft für Entwicklung und Produktion solarer Energiesysteme, Wirtschaft und Infrastruktur & Co Planungs-KG, TiNOX GmbH, Greece: Capital Connect Consultants, Centre for Renewable Energy Sources, Hellas Energy Italy: European Desalination Society, University of Palermo Netherlands: Aquamarine Power Portugal Ao Sol, Energias Renováveis, Instituto Nacional De Engenharia Tecnologia e Inovação Spain: Befesa Construcción y Tecnología Ambiental, Instituto Tecnológico de Canarias, Technology, Environment and Energy Research Centre
International Desalination Agency – IDA http://idadesal.org	Companies, R&D centres and private individuals
Deutsche Meerwasser Entsalzung www.dme-ev.de/en/	Companies, R&D centres
Saline Water Conversion Corporation www.swcc.gov.sa	Governmental organisation Saudi Arabia
Middle East Desalination Research Center www.medrc.org/	Governmental organisation Oman

<p>National Centre of Excellence in Desalination http://perdayesalination.edu.au/</p>	<p>Murdoch University, Commonwealth Scientific and Industrial Research Organisation, Curtin University of Technology, Deakin University, Edith Cowan University, Flinders University, Monash University, University of New South Wales, University of Queensland, University of South Australia, University of Technology Sydney, Victoria University, University of Western Australia, University of Wollongong</p>
---	---

b) Research and Development Institutions

Name	Contact Person/URL	Focus
Massachusetts Institute of Technology	Steven Dubowsky (dubowsky@mit.edu) Department of Mechanical Engineering – Field and Space Robotics Laboratory http://robots.mit.edu/projects/KFUPM/index.html	Decentralised PV-RO
Technical University Munich	Markus Spinnler Spinnler@td.mw.tum.de Lehrstuhl für Thermodynamik	PVT-RO
Cyprus Institute	Aristides Bonanos (a.bonanos@cyi.ac.cy) Energy, Environment and Water Research Center www.cyi.ac.cy/eewrc/eewrc-research-projects/solar-energy-and-desalination.html	CSP-MED
Karlsruhe Institute of Technology	Andrea Schäfer: andrea.iris.schaefer@kit.edu Department of Membrane Technology Florenca Saravia: florenca.saravia@kit.edu Engler Bunte Institute	Decentralised PV-RO
King Abdulaziz City for Science and Technology	www.kacst.edu.sa	
King Abdullah University for Science and Technology KAUST	www.kaust.edu.sa/	
King Abdulaziz University	www.kau.edu.sa	MD
King Abdullah City for Atomic and Renewable Energy	www.kacare.gov.sa/en/	All
Masdar Institute	www.masdar.ac.ae/	MD
Centro de Investigaciones Energéticas,	Dr. Diego-César Alarcón-Padilla Head of Solar Desalination Unit Email: diego.alarcon@psa.es	MED, MD

Medioambientales y Tecnológicas	Dr. Guillermo Zaragoza Solar desalination Email: guillermo.zaragoza@psa.es www.ciemat.es , www.psa.es	
Instituto Tecnológico de Canarias	Dr. Baltasar Peñate Suárez Head of Water Department - R&D Division baltasarp@itccanarias.org www.itc-canarias.org www.itccanarias.org/web/servicios/agua/formacion-eng.html Online course: 'Introduction to renewable energy desalination' www.desreslearning.com	All
Agricultural University of Athens	Prof. Dr. George Papadakis, Agricultural University of Athens Dept. of Natural Resources and Agricultural Engineering Email: gpap@aua.gr www.renewables.aua.gr	

6.3 Best Practice for Deploying Island Renewable Desalination

A wide range of renewable desalination systems and their implementation potential have been evaluated above, but the choice made by any specific island has to be based on the site conditions.

The site requirements need to be first assessed in terms of water demand and availability in the region. This generates the water demand to be met through renewable desalination. In addition, solar and wind resources need to be assessed to work out renewable energy desalination costs with different technology options at the specific site.

If grid connection is available, CSP-MED or a combination of PV, CSP or wind energy with RO can be relevant options. If the site is off-grid, solutions should be considered like PV-RO with or without battery, off-grid wind-RO and CSP-MED. The cost can be compared to existing water and energy prices considering future price increases by using the results of this study. The cost of water produced on the basis of solar and wind resources can be estimated using the graphs in chapter 5.

Other options should also be taken into account. In some locations, solar resources may be low. Wave or ocean thermal energy may have the potential to provide electricity while conditions for geothermal energy exploitation may be favourable. In these situations, these technologies should also be considered. Technology combinations like CSP-MED-RO should be assessed too. Site conditions may make adopted solutions attractive.

Following this broad cost estimation approach, a detailed study is necessary of the cost of renewable desalination at the site. Environmental impacts and acceptance issues should be taken into account in addition to cost considerations before planning the selected desalination system. Figure 23 displays a brief guide on how to choose the right renewable desalination system.

Figure 23: Guide to selecting a renewable desalination technology

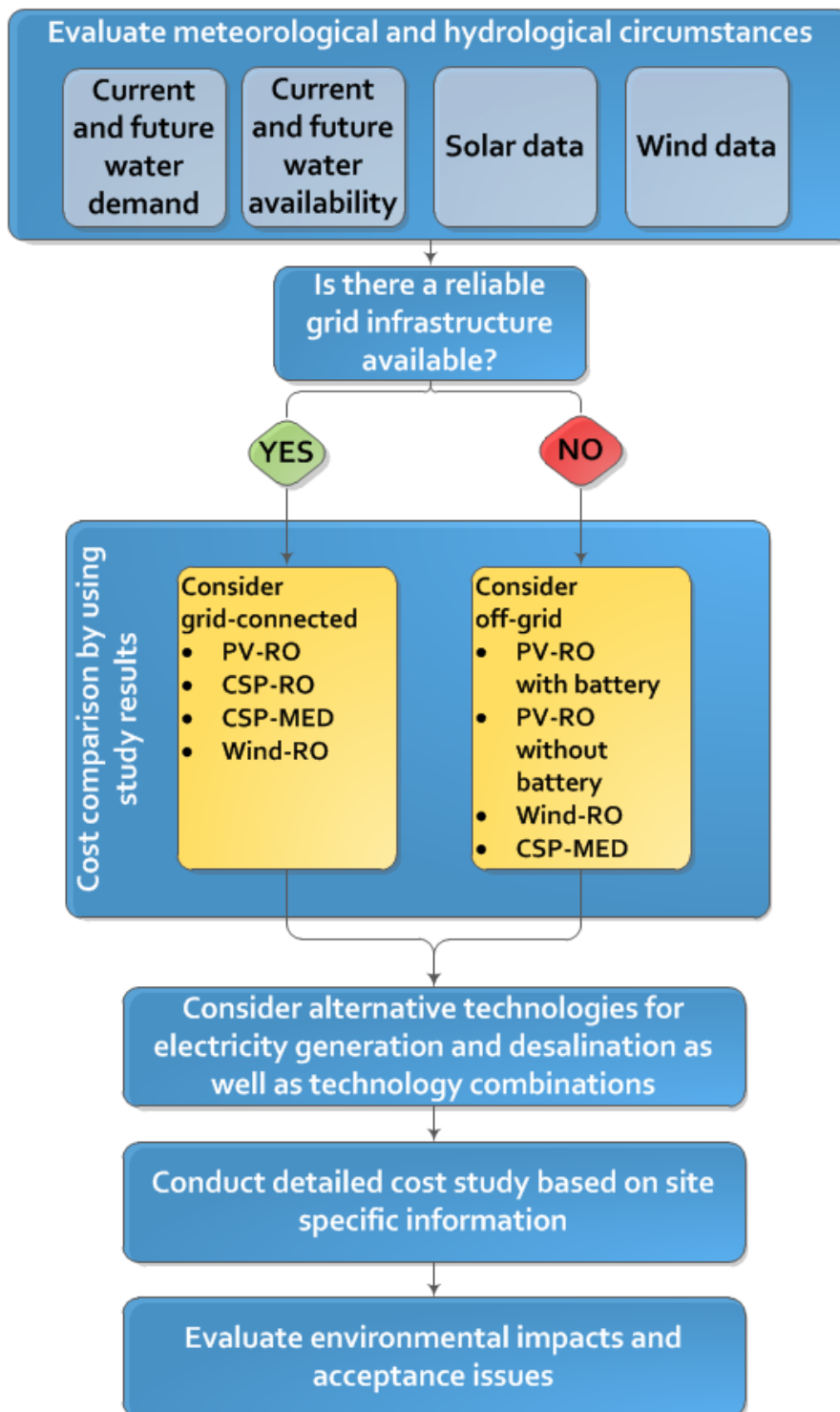

Future Potential Renewable Desalination

There are two different options for increasing the share of renewable energy supply in desalination. Either new desalination systems are fitted directly with renewable energy supply or renewable energy sources supplement the conventional energy supply for running desalination plants. The analysis of desalination capacities already installed and technologies already deployed is therefore important. That analysis will show the present significance of desalination for a particular island and also indicate the potential for future developments and installations.

The bar charts in Figure 24 and Figure provide an overview of present desalination on a range of small islands. The electric desalination technologies RO and ED are combined in one bar but are clearly dominated by RO. MED and MSF are combined in the second superimposed bar. MED clearly dominates these island thermal systems. Figure 24 provides an overview of capacities of 20,000-230,000 m³/day.

Figure 24: Desalination Capacities Greater than 20,000 m³/day

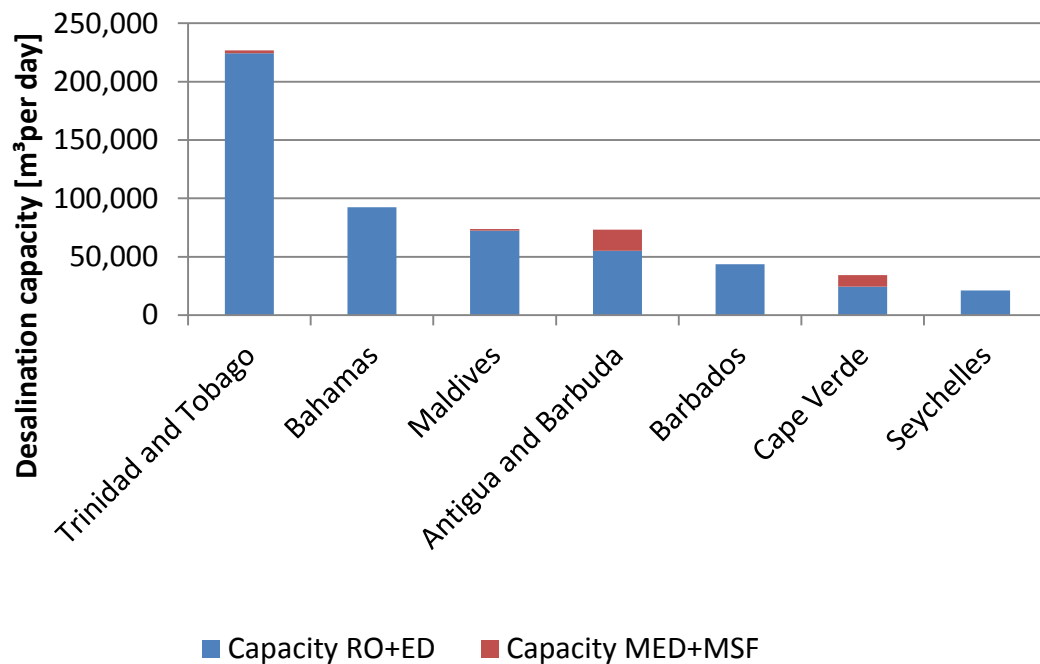
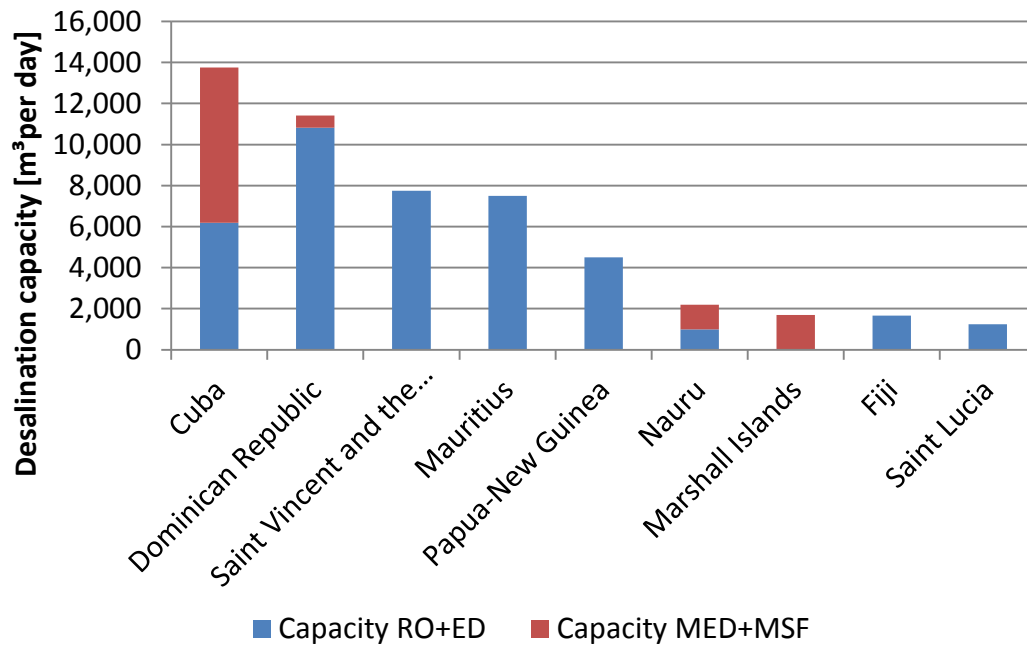

Figure 25 provides an overview of islands with lower capacities of 1,200-14,000 m³/day. Further analysis of future desalination demand and renewable desalination potential on different islands means investigating the individual boundary conditions and impact factors.

Figure 25: Desalination Capacities Less than 20,000 m³/day



It is clear that most of the islands are supplied mainly or even entirely by RO. For instance, MED is still the dominant technology in Cuba, but only one MED plant has been operating since 1990. All five later plants were based on RO. In the Marshall islands, only two MED plants have been operating, one since 1985 and the other since 1994.

To analyse the potential for renewable desalination, one must know the desalinated share of fresh water withdrawal on particular islands. This provides insight into water shortage and desalination demand.

Table 19 provides an overview of fresh water withdrawal and desalination capacities on a range of islands. Gaps in data availability on some islands create a mismatch in desalination capacities and water withdrawal.

Table 19: Overview of Onstream Desalination Capacity and Total Fresh Water Withdrawal for a Range of Islands

Island	Total fresh water withdrawal [m ³ /day]	Year and source of data collection	Onstream desalination capacity 2014 [m ³ /day]
Trinidad and Tobago	868,500	2013 World Bank	226,855
Bahamas	159,900		92,351
Maldives	27,400	2008 World Fact book	73,837
Antigua and Barbuda	27,000	2005 World Fact book	73,125
Barbados	273,973	2013 World Bank	43,516
Cabo Verde	54,800	2004 World Fact book	36,923
Seychelles	0		21,206
Cuba	11,894,710	2013 World Bank	13,761
Dominican Republic	49,100	2013 World Bank	11,415
Saint Vincent	26,223	1995 World Fact book	7,747
Mauritius	2,071,496	2013 World Bank	7,499
Papua New Guinea	1,100,500	2013 World Bank	4,500
Nauru			2,300
Marshall islands			1,700
Fiji	247,454	2013 World Bank	1,670
Saint Lucia	55,000	2005 World Fact book	1,250
Kiribati			110
Comoros	35,507		0

Examples of Successful Initiatives in Small Island Developing States

In May 2009, Pacific Island Forum leaders met with the Government of Japan at the Fifth Pacific Island Leaders Meeting and issued the Islands Hokkaido Declaration. A significant part of the declaration was the launch of the Pacific Environment Community fund. This initiative is designed to promote the development and implementation of practical approaches adapted to the Pacific region for combating climate change impacts. The Government of Japan made a contribution of about USD 66 million to the fund to help FICs manage climate change issues. The focus was on the provision of solar power generation systems and seawater desalination plants or a combination of both [80]. Following this initiative, 29 plants of approximately 1-100 m³/day were contracted and built. Table 20 provides an overview of the plants installed according to project descriptions published by the Pacific Island Forum Secretariat [81].

Table20: PV-RO Systems Installed with Support from the Pacific Environment Community Fund

Location	Technology	Application	Total capacity	System capacity	Status	System provider
Marshall Islands	PV-RO	15 plants for fresh water supply to schools in outer islands	9-18 m ³ /day	600-1,200 litres/day	In use since 2014	Toyota Tsusho Corporation, Toray
Nauru	PV-RO & power	Fresh water supply to community	100 m ³ /day	100 m ³ /day	In use since end 2013	Hitachi Plant Technologies Japan
Palau (Peleliu)	PV-RO & power	Fresh water supply to community	100 m ³ /day	150 litres per person/day	In use since March 2014	Hitachi Plant Technologies Japan
Tuvalu (Funafuti)	PV-RO	Fresh water supply to community	120 m ³ /day	1x100 m ³ /day - 2x10 m ³ /day	in use since September 2013	Hitachi Plant Technologies Japan
Vanuatu (Ambae, Aniwa)	PV-RO	Fresh water supply to hospital/ population	110 m ³ /day	1x100 m ³ /day - 1x10 m ³ /day	In use since 2014	Hitachi Plant Technologies Japan
Fiji (Kia, Viwa, Vanuavatu, Kavewa)	PV-RO	Fresh water supply on four islands (174 households) seven plants	136 m ³ /day	7x20 m ³ /day	In operation since 2014	NBK Corporation Japan

References

- [1] Mirti, A.V. and S. Davies (2005), "Drinking Water Quality in the Pacific Island Countries: Situation Analysis and Needs Assessment", SOPAC Joint Contribution Report 181 2005, www.pacificwater.org/userfiles/file/jc0181.pdf.
- [2] Bailey, R.T., J.W. Jenson and A.E. Olsen (2010), "Estimating the Ground Water Resources of Atoll Islands," *Water*, No. 2, Vol. 1, pp. 1-27.
- [3] García-Rodríguez, L. (2003), "Renewable Energy Applications in Desalination: State of the Art," *Solar Energy*, Vol. 75, No.5, pp. 381-393.
- [4] Hophmayer-Tokich, S., and T. Kadiman (2013), "Water Management on Islands - Common Issues and Possible Actions", a concept paper in preparation to the international workshop: "Capacity Building in Water Management for Sustainable Tourism on Islands", www.utwente.nl/mb/cstm/reportsperdaydownloads/watermanagement_on_islands.pdf.
- [5] Bonell, M., M.M. Hufschmidt and J.S. Gladwell (1993), *Hydrology and Water Management in the Humid Tropics: Hydrological Research Issues and Strategies for Water Management*, Cambridge University Press., Cambridge.
- [6] Barnett, J., and J. Campbell (2010), *Climate Change and Small Island States: Power, Knowledge, and the South Pacific*, Earthscan, pp. 218.
- [7] Niles, K., and B. Lloyd (2013), "Small Island Developing States (SIDS) and Energy Aid: Impacts on the Energy Sector in the Caribbean and Pacific", *Energy for Sustainable Development*, Vol. 17, No. 5, pp. 521-530.
- [8] David Scott, *et al.* (2003), "Pacific Dialogue on Water and Climate: Synthesis Report", www.oas.org/cdwc/Documents/SIDS%20Paper/Pacific%20Report%20-%20Final.pdf.
- [9] Overmars, M. and S.B. Gottlieb (2009), "Perspectives on Water and Climate Change Adaptation: Adapting to Climate Change in Water Resources and Water Services in Caribbean and Pacific Small Island Countries", www.worldwatercouncil.org/fileadmin/www/Library/Publications_and_reports/Climate_Change/PersPap_03._Small_Island_Countries.pdf.
- [10] Garcia-Ruiz, J.M., *et al.* (2011), "Mediterranean Water Resources in a Global Change Scenario", *Earth-Science Reviews*, Vol. 105, No. 3-4, pp. 121-139.
- [11] IPCC (Intergovernmental Panel on Climate Change) (2014), "Climate Change 2014: Impacts, Adaption, and Vulnerability", Working Group II, Intergovernmental Panel on Climate Change, Geneva, <https://ipcc-wg2.gov/AR5/report/>.
- [12] Rijsberman, F.R. (2006), "Water Scarcity: Fact or Fiction?" *Agricultural Water Management*, Vol. 80, No. 1-3, pp. 5-22.
- [13] Gleick, P.H., *et al.* (2011), *The World's Water Volume 7: The Biennial Report on Fresh water Resources*, Island Press, Washington, D.C., pp. 440.
- [14] UNEP (United Nations Environment Programme) (2012), *Tourism in the Green Economy: Background Report*, United Nations World Travel Organisation,

www.unep.org/greeneconomy/Portals/88/documents/ger/ger_final_dec_2011/Tourism%20in%20the%20green_economy%20unwto_unep.pdf.

[15] **DesalData** (2014), www.desaldata.com/.

[16] **Caribbean Journal** (2014), *Grenada Building Reverse Osmosis Plants on Carriacou, Petite Martinique*, 22 May, www.caribjournal.com/2014/05/22/grenada-building-reverse-osmosis-plants-on-carriacou-petite-martinique/.

[17] **The International Desalination & Water Reuse Quarterly industry website** (2014), "Grenada government tries again with RO desalination", www.desalination.biz/news/news_story.asp?id=7571.

[18] **Metutera, T. (n.d.)**, "Water Resources Management in Kiribati with Special Emphasis on Groundwater Development Using Infiltration Galleries", Public Utilities Board, Kiribati, www.pacificwater.org/userfiles/file/Case%20Study%20D%20THEME%201%20Kiribati%20on%20Groundwater%20Development.PPT.

[19] **Radio New Zealand International** (2013), "Vanuatu Desalination Plants to Supply 11,000 people", www.radionz.co.nz/international/pacific-news/219340/vanuatu-desalination-plants-to-supply-11,000-people.

[20] **SIDSnet** (2014), www.sidsnet.org/.

[21] **ICDC (Integrated Climate Data Center)** (2014), "Integrated Island Database (IIDAB)", Hamburg University, <http://icdc.zmaw.de/1/daten/society/iidab.html>.

[22] **Ali, M.T., H.E. Fath and P.R. Armstrong** (2011), "A Comprehensive Techno-Economical Review of Indirect Solar Desalination," *Renewable and Sustainable Energy Reviews*, Vol. 15, No. 8, pp. 4187-4199.

[23] **Eltawil, M.A., Z. Zhengming and L. Yuan** (2009), "A Review of Renewable Energy Technologies Integrated with Desalination Systems," *Renewable and Sustainable Energy Reviews*, Vol. 13, No. 9, pp. 2245-2262.

[24] **IRENA (International Renewable Energy Agency)** (2014), *A Path to Prosperity: Renewable Energy for Islands*, IRENA, Abu Dhabi.

[25] **Bauforumstahl, Heizwerte**, (2014), www.bauforumstahl.de/upload/documents/brandschutz/kennwerte/Heizwertfluessig.pdf

[26] **Specifications for Diesel Generators** (2014), http://generators.findthebest.com/site_search/What-is-the-most-efficient-Diesel-generator.

[27] **Pointner, P.L., et al.** (2010), "Image Study Diesel Power Plants Study on Image and Actual Potential of Engine-based Power Plants", K.D. Treuhand-Gesellschaft, et al.

[28] **U.S. Energy Information Administration** (2014), "Table 8.1. Average Operating Heat Rate for Selected Energy Sources", www.eia.gov/electricity/annual/html/epa_08_01.html.

[29] **Kost, C., et al.** (2013), *Levelized Cost of Electricity Renewable Energy Technologies*, Fraunhofer Institute for Solar Energy Systems ISE: Freiburg.

[30] **Pacific Region Infrastructure Facility** (2009), "The Pacific Region Infrastructure Facility (PRIF) - Kiribati Infrastructure Sector Review",

<http://prdrse4all.spc.int/production/node/4/content/pacific-region-infrastructure-facility-prif-kiribati-infrastructure-sector-review>.

- [31] Briceno-Garmendia, C.M., and D.A. Benitez (2010), *Cabo Verde's Infrastructure: A Continental Perspective - AICD Country Report*, Africa Infrastructure Country Diagnostic.
- [32] Electricity Tariff (2014), "Electricity Tariffs and Rates", www.fea.com.fj/pages.cfm/customer-care/tarriffs-rates.html.
- [33] Dornan, M., and F. Jotzo (2011), *Electricity Generation in Fiji: Assessing the Impact of Renewable Technologies on Costs and Financial Risk*, Australian Agricultural and Resource Economics Society: Melbourne.
- [34] SPC (Secretariat of the Pacific Community) (2013), Pacific Fuel Price Monitor, SPC, New Caledonia.
- [35] IRENA (2012), *Kiribati: Renewables Readiness Assessment*, IRENA, Abu Dhabi.
- [36] IRENA (2013), *Renewable Energy Opportunities and Challenges in the Pacific Islands Region*, IRENA, Abu Dhabi.
- [37] World Health Organisation (2003), *Domestic Water Quantity, Service Level and Health*, World Health Organisation, Geneva.
- [38] DesalData (2014), "SeaWater Reverse Osmosis (SWRO) Costs Estimator 2013", www.desaldata.com/cost_estimator.
- [39] Verdier (2011), "Mena Regional Water Outlook - Part II Desalination Using Renewable Energy", Fichtner, Stuttgart, www.dlr.de/tt/Portaldata/41/Resources/dokumente/institut/system/projects/MENA_REGIONAL_WATER_OUTLOOK.pdf.
- [40] IPART (Independent Pricing and Regulatory Tribunal) New South Wales (issuing body) (2013), *Review of water prices for Sydney Desalination Plant Pty Limited from 1 July 2012: water: final report*, Sydney, NSW IPART.
- [41] Cipollina, A., G. Micale, and L. Rizzuti, L. (2009), *Seawater Desalination: Conventional and Renewable Energy Processes*, Springer.
- [42] Li, C., Y. Goswami and E. Stefanakos (2013), "Solar Assisted Sea Water Desalination: a Review", *Renewable and Sustainable Energy Reviews*, Vol. 19, pp. 136-163.
- [43] Zejli, D., *et al.* (2011), "An Optimization Model for a Mechanical Vapor Compression Desalination Plant Driven by a Wind/PV Hybrid System", *Applied Energy*, Vol. 88, No. 11, pp. 4042-4054.
- [44] B. Peñate, d.I.F, J.A., Barreto, M. (2010), "Operation of the RO Kinetic® Energy Recovery System: Description and Real Experiences", *Desalination*, Vol. 252, pp. 179 - 185.
- [45] DOW (2004), "FILMTEC™ Reverse Osmosis Membranes: Understanding RO Element Salt Rejection Specifications", www.che.utah.edu/department_equipment/Projects_Lab/M_Ultrafiltration/MIS_Understanding_RO.pdf
- [46] Strathmann, H. (2010), "Electrodialysis, a Mature Technology with a Multitude of New applications", *Desalination*, Vol. 264, No. 3, pp. 268-288.

- [47] Peñate, B., *et al.* (2013), "Design and Testing of an Isolated Commercial EDR Plant Driven by Solar Photovoltaic Energy", *Desalination and Water Treatment*, Vol. 51, pp. 1254-1264.
- [48] Narayan, G.P., *et al.* (2010), "The Potential of Solar-Driven Humidification-Dehumidification Desalination for Small-Scale Decentralized Water Production", *Renewable and Sustainable Energy Reviews*, Vol. 14, No.4, pp. 1187-1201.
- [49] Bogner, K. (2013), "Energy and water supply systems in remote regions considering renewable energies and seawater desalination", Reiner Lemoine-Stiftung, Technische Universität, Berlin, www.reiner-lemoine-stiftung.de/pdf/dissertationen/dissertation_bogner.pdf.
- [50] Sorensen, B. (2010), *Renewable Energy: Physics, Engineering, Environmental Impacts, Economics & Planning*, Elsevier Science.
- [51] Fujita, R., *et al.* (2012), "Revisiting Ocean Thermal Energy Conversion", *Marine Policy*, Vol. 36, No. 2, pp. 463-465.
- [52] Tchanche, B.F., *et al.* (2011), "Low-Grade Heat Conversion into Power Using Organic Rankine Cycles - a Review of Various Applications", *Renewable & Sustainable Energy Reviews*, Vol. 15, No. 8, pp. 3963-3979.
- [53] Devis-Morales, A., *et al.* (2014), "Ocean Thermal Energy Resources in Colombia", *Renewable Energy*, Vol. 66, pp. 759-769.
- [54] Etemadi, A., *et al.* (2011), "Electricity Generation by the Ocean Thermal Energy", *Proceedings of International Conference on Smart Grid and Clean Energy Technologies (Icsgce 2011)*, 12.
- [55] Zhao, S., *et al.* (2012), "Recent Developments in Forward Osmosis: Opportunities and Challenges", *Journal of Membrane Science*, Vol. 396, pp. 1-21.
- [56] McGovern, R.K. and Lienhard V, J.H. (2014), "On the Potential of Forward Osmosis to Energetically Outperform Reverse Osmosis Desalination", *Journal of Membrane Science*, Vol. 469, pp. 245-250.
- [57] Khawaji, A.D., I.K. Kutubkhanah and J-M. Wie (2008), "Advances in Seawater Desalination Technologies", *Desalination*, Vol. 221, No. 1-3, pp. 47-69.
- [58] Quaschnig, V. (2007), *Regenerative Energiesysteme: Technologie - Berechnung - Simulation ; mit 97 Tabellen und einer DVD (Renewable Energy Systems Technology - Calculation - Simulation; with 97 tables and a DVD)*, Hanser.
- [59] Ma, Q. and H. Lu (2011), "Wind Energy Technologies Integrated with Desalination Systems: Review and State-of-the-Art", *Desalination*, Vol. 277, No. 1-3, pp. 274-280.
- [60] Charcosset, C. (2009), "A Review of Membrane Processes and Renewable Energies for Desalination", *Desalination*, Vol. 245, No. 1, pp. 214-231.
- [61] Missimer, T.M., *et al.* (2013), "Subsurface Intakes for Seawater Reverse Osmosis Facilities: Capacity Limitation, Water Quality Improvement and Economics", *Desalination*, Vol. 322, pp. 37-51.
- [62] Al-Karaghoul, A. and Kazmerski, L.L (2013), "Energy Consumption and Water Production Cost of Conventional and Renewable-Energy-Powered Desalination Processes", *Renewable and Sustainable Energy Reviews*, Vol. 24, pp. 343-356.

- [63] Iaquaniello, G., *et al.* (2014), "Concentrating Solar Power (CSP) System Integrated with MED-RO Hybrid Desalination," *Desalination*, Vol. 336, pp. 121-128.
- [64] Palenzuela, P., *et al.* (2013), "Evaluation of Cooling Technologies of Concentrated Solar Power Plants and their Combination with Desalination in the Mediterranean Area," *Applied Thermal Engineering*, Vol. 50, No. 2, pp. 1514-1521.
- [65] Koklas, P.A. and S.A. Papathanassiou (2006), "Component Sizing for an Autonomous Wind-Driven Desalination Plant," *Renewable Energy*, Vol. 31, No. 13, pp. 2122-2139.
- [66] Abraham, T. and A. Luthra (2011), "Socio-Economic & Technical Assessment of Photovoltaic Powered Membrane Desalination Processes for India," *Desalination*, Vol. 268, No. 1, pp. 238-248.
- [67] Helal, A.M. and S.A. Al-Malek (2006), "Design of a Solar-Assisted Mechanical Vapor Compression (MVC) Desalination Unit for Remote Areas in the UAE," *Desalination*, Vol. 197, No. 1-3, pp. 273-300.
- [68] Charcosset, C. (2009), "A review of membrane processes and renewable energies for desalination," *Desalination*, Vol. 245, No. 1-3, pp. 214-231.
- [69] Banat, F. and N. Jwaied (2008), "Economic Evaluation of Desalination by Small-Scale Autonomous Solar-Powered Membrane Distillation Units," *Desalination*, Vol. 220, No. 1, pp. 566-573.
- [70] Li, X., *et al.* (2014), "Experimental Study on a Humidification and Dehumidification Desalination System of Solar Air Heater with Evacuated Tubes," *Desalination*, Vol. 351, pp. 1-8.
- [71] Photovoltaic Geographical Information System - Interactive Maps (2014), Performance of Grid-connected PV, <http://re.jrc.ec.europa.eu/pvgis/apps4/pvest.php>.
- [72] BWE (Bundesverband WindEnergie e.V.) (German Wind Energy Association e.V) (2010), *Wirtschaftlichkeit und Vergütung von Kleinwindenergieanlagen (Profitability and remuneration of small wind turbines)*, Bundesverband WindEnergie E.V., pp. 25.
- [73] Kleinwindkraft-Portal (Small Wind Turbine Portal) (2012), "Preise für Kleinwindkraftanlagen richtig deuten und Fehlinvestitionen vermeiden (Welcome to the German Small Wind Turbine Portal!)", 7 September 2012, www.klein-windkraftanlagen.com/welcome-to-the-german-small-wind-turbine-portal/
- [74] Ghaffour, N., T.M. Missimer and G.L. Amy (2013), "Technical Review and Evaluation of the Economics of Water Desalination: Current and Future Challenges for Better Water Supply Sustainability," *Desalination*, Vol. 309, pp. 197-207.
- [75] World Health Organisation (2011), *Valuing Water, Valuing Livelihoods Guidance on Social Cost-Benefit Analysis of Drinking-Water Interventions, with Special Reference to Small Community Water Supplies*, World Health Organisation, Geneva, www.who.int/water_sanitation_health/publications/2011/valuing_water/en/.
- [76] Genthner, K. (2001), "Strategies and Perspectives for Collaborative Regional Capacity Building in Desalination", *Desalination*, Vol. 141, No. 2, pp. 101-107.
- [77] Mahmoudi, H., O. Abdellah and N. Ghaffour (2009), "Capacity Building Strategies and Policy for Desalination Using Renewable Energies in Algeria", *Renewable and Sustainable Energy Reviews*, Vol. 13, No. 4, pp. 921-926.

- [78] Kennedy, M., I. Bremere and J. Schippers (2001), "Capacity Building in Desalination: a Case Study on Selected Activities in the Netherlands", *Desalination*, Vol. 141, No. 2, pp. 199-204.
- [79] World Health Organisation (2020), "Small and Safe - Investing in Small Community Water Supplies will Reduce Waterborne Disease Outbreaks and Overall Costs", *Clean Water for a Healthy World*, brochure for World Water Day, World Health Organisation, Geneva.
- [80] UNDESA (United Nations Department of Economic and Social Affairs) (2014), "Pacific Environment Community Fund Ref# 2649", www.sids2014.org/index.php?page=view&type=1006&nr=2649&menu=1507.
- [81] Pacific Islands Forum Secretariat (2015), "Pacific Environment Community (PEC) Fund", www.forumsec.org/pages.cfm/strategic-partnerships-coordination/pacific-environment-community-pec-fund.html.
- [82] Konstantin, P. (2006), *Praxisbuch Energiewirtschaft: Energieumwandlung, - Transport und -Beschaffung im Liberalisierten Markt*, (Praxisbuch energy: energy conversion, - transport and procurement in the liberalized market), Springer.
- [83] Grenada Industrial Development Corporation (2010), "Utilities Fact Sheet", www.grenadaworld.com/LinkClick.aspx?fileticket=Flrp5kKRgQc%3D&tabid=37.
- [84] Office of Te Beretitenti & T'Makei Services (2012), "Republic of Kiribati Island Report Series, Tarawa", www.climate.gov.ki/wp-content/uploads/2013/01/5_NORTH-TARAWA-revised-2012.pdf
- [85] Electra (n.d.), "Water and Electricity Tarrifs", www.electra.cv/index.php/Contratacao/tarifas.htm, accessed October 2014.
- [86] Municipality of Mykonos (2014), "D.E.Y.A.M. Pricing Policy", www.mykonos.gr/index.php?MDL=pages&Branch=N_N0000000100_N0000010026_N0000010041_N0000010064_S0000000423.
- [87] Schlegelmilch, K., P. Maro and S. Speck (2010), "Options for Promoting Environmental Fiscal Reform in Ec Development Cooperation", Framework Contract Commission 2007, Lot 4 Contract Nr 2008/165659, www.foes.de/pdf/2010-10_Environmental_Fiscal_Reform_EC_DC.pdf.
- [88] APUA (Antigua Public Utilities Authorities) (n.d.), "Water Business Unit", www.apua.ag/business/water-division/, accessed October 2014.

Annex

Annex I: LCOE method

Levelised cost of electricity (LCOE) calculation is derived from the net present value method through which investment and operational expenses are included during the plant's lifetime. All cost data are calculated in USD. Total lifetime costs include investment and operation. The sum of all expenses is divided by the sum of the electricity output. The following formula is used to work out LCOE for new projects in the year they are installed [82]:

$$LCOE = \frac{I_0 + \sum_{t=1}^n \frac{A_t}{(1+i)^t}}{\sum_{t=1}^n \frac{M_{el}}{(1+i)^t}}$$

LCOE in USD/kWh

I_0 = investment in USD

A_t = annual total costs in USD/annum

M_{el} = electricity output in kWh per year

i = interest rate (discount rate)

n = economic lifetime in years

t = year of operation (1, 2,... n)

The electricity output is discounted to achieve a constant LCOE over time. Annual total costs include the fixed and variable operational project, maintenance, service replacements and insurance costs. The WACC method is the basis for calculating share of debt and equity, and this influences the discount rate. WACC depends on equity ratio, equity return, debt ratio and interest on debt capital. This means the formula for annual total costs is contained in the LCOE calculation [29]:

Annual total costs =

fixed operational costs +

variable operating costs +

(residual value, dismantling system)

Annex II: LWC method

Levelised cost of water (LWC) describes the cost of each m³ of water in today's units. The calculation method is described in eq. 1 and eq. 2 below. The calculation includes the investment cost I_0 and the annual cost for operating desalination plant A_t in each year t . The annual costs are discounted to today's value by using discount rate i . The amount of water produced each year, M_{water} , is discounted in years over the lifetime n of the plant.

$$LWC = \frac{I_0 + \sum_{t=1}^n \frac{A_t}{(1+i)^t}}{\sum_{t=1}^n \frac{M_{water}}{(1+i)^t}} \quad \text{eq. 1}$$

$$A_t = OPEX_{el} + C_{el} \quad \text{eq. 2}$$

The total annual costs contain costs for chemicals, other consumables, personnel, maintenance, membrane replacement, insurance costs and electricity costs. In the calculation, the electricity costs are separated from the other OPEX costs as they vary depending on the location of the plant and the source of energy used. The total annual cost A_t is therefore composed of OPEX excluding electricity cost, $OPEX_{el}$, plus the electricity cost C_{el} .



www.irena.org

Copyright © IRENA 2015