

GREEN HYDROGEN COST REDUCTION

**SCALING UP
ELECTROLYSERS**
TO MEET THE 1.5°C
CLIMATE GOAL

H₂

O₂

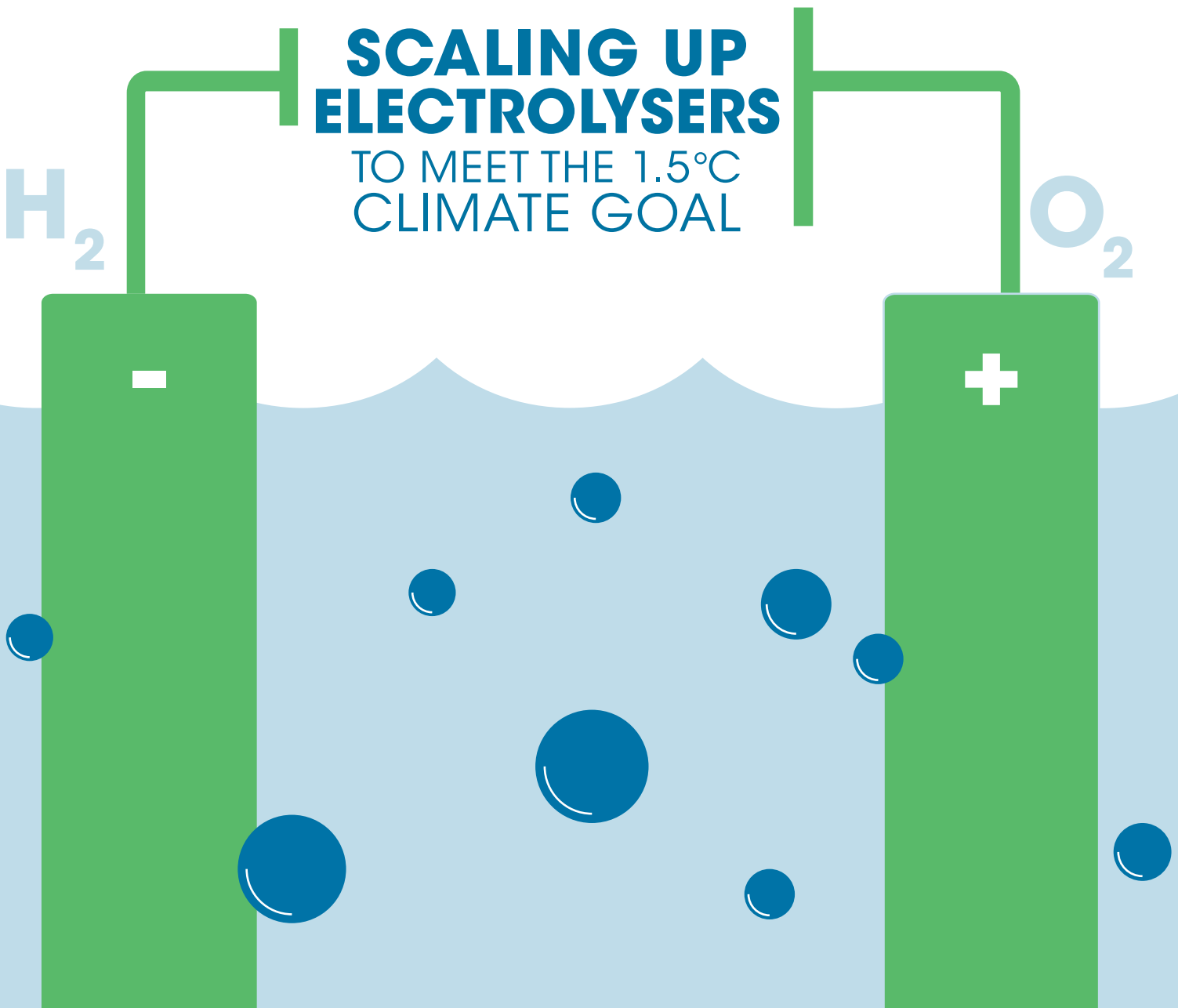

© IRENA 2020

Unless otherwise stated, material in this publication may be freely used, shared, copied, reproduced, printed and/or stored, provided that appropriate acknowledgement is given of IRENA as the source and copyright holder. Material in this publication that is attributed to third parties may be subject to separate terms of use and restrictions, and appropriate permissions from these third parties may need to be secured before any use of such material.

ISBN: 978-92-9260-295-6

Citation: IRENA (2020), *Green Hydrogen Cost Reduction: Scaling up Electrolysers to Meet the 1.5°C Climate Goal*, International Renewable Energy Agency, Abu Dhabi.

Acknowledgements

This report benefited from input and review of the following experts: Katherine Ayers and Egil Rasten (NEL), Karan Bagga (ThyssenKrupp), Bart Biebuyck and Mirela Atanasiu (FCH JU), Luigi Crema and Martina Trini (Bruno Kessler Foundation), Tim Karlsson (IPHE), Ruud Kempener (European Commission), Francesco Massari (XBEC), Corky Mittelsteadt (Giner ELX), Samir Rachidi (IRESEN), Jan-Justus Schmidt (Enapter), Toshiyuki Shirai (METI/Japan), Andrew Smeltz (Denora), Denis Thomas (Cummins-Hydrogenics), Kasper Tipsmark (Green Hydrogen Systems), Eveline Weidner (EU JRC) and Frank Wouters (EU-GCC clean energy council). Emanuele Bianco, Paul Durrant, Barbara Jinks, Seungwoo Kang, Paul Komor and Stephanie Weckend (IRENA) also provided valuable inputs.

The report was edited by Jonathan Gorvett.

Authors: Emanuele Taibi, Herib Blanco and Raul Miranda (IRENA) and Marcelo Carmo (Forschungszentrum Jülich). The study was supervised by Dolf Gielen and Roland Roesch (IRENA).

Report available online: www.irena.org/publications

For questions or to provide feedback: publications@irena.org

IRENA is grateful for the support of the German Federal Ministry for Economic Affairs and Energy (BMWi) of the Federal Republic of Germany and the Ministry of Economy, Trade and Industry (METI) of Japan in producing this publication.

Disclaimer

This publication and the material herein are provided “as is”. All reasonable precautions have been taken by IRENA to verify the reliability of the material in this publication. However, neither IRENA nor any of its officials, agents, data or other third-party content providers provides a warranty of any kind, either expressed or implied, and they accept no responsibility or liability for any consequence of use of the publication or material herein.

The information contained herein does not necessarily represent the views of all Members of IRENA. The mention of specific companies or certain projects or products does not imply that they are endorsed or recommended by IRENA in preference to others of a similar nature that are not mentioned. The designations employed and the presentation of material herein do not imply the expression of any opinion on the part of IRENA concerning the legal status of any region, country, territory, city or area or of its authorities, or concerning the delimitation of frontiers or boundaries.

FOREWORD

While 2020 may be remembered for the tragic COVID-19 crisis, it has also been an unprecedented year for the global energy transition and the growing momentum of hydrogen technology. Many countries, in aligning their pandemic response with longer-term goals, have announced strategies to develop hydrogen as a key energy carrier. In parallel, numerous countries, cities and companies have adopted net-zero targets for energy-related carbon dioxide (CO₂) emissions, bringing the need for hydrogen to the forefront.

But not all types of hydrogen are compatible with sustainable, climate-safe energy use or net-zero emissions. Only “green” hydrogen – produced with electricity from renewable sources – fulfils these criteria, which also entail avoiding “grey” and hybrid “blue” hydrogen. Green hydrogen forms a cornerstone of the shift away from fossil fuels. Its uptake will be essential for sectors like aviation, international shipping and heavy industry, where energy intensity is high and emissions are hardest to abate.

Green hydrogen, however, cannot take off without widespread and co-ordinated support across the value chain. The Collaborative Framework on Green Hydrogen, set up by the International Renewable Energy Agency (IRENA) in mid-2020, offers a platform to strengthen support in co-operation with IRENA’s member countries and partners. IRENA studies in 2018-19 highlighted the technical and economic feasibility, while a recent policy-making guide outlines key enabling policies for green hydrogen. Business models, for their part, require careful consideration.

The present study, Green hydrogen cost reduction, adds a vital strategic building block, providing insights on how to make this clean supply option widely available and economical.

Only five countries had announced their hydrogen strategies by the end of 2019. A year on, nearly 20 have done so, with at least 10 more set to follow within months. Industry investors plan at least 25 gigawatts (GW) of electrolyser capacity for green hydrogen by 2026. Still, far steeper growth is needed – in renewable power as well as green hydrogen capacity – to fulfil ambitious climate goals and hold the rise in average global temperatures at 1.5°C.



Energy diversification, when based on renewables, can eliminate emissions and fulfil climate pledges. Green hydrogen uptake, of course, would reduce the need for carbon capture by simply providing cleaner energy.

Yet significant barriers remain. Green hydrogen costs, on average, between two and three times more to make than blue hydrogen, with the true potential and viability of the latter requiring further investigation. With electricity input accounting for much of the production cost for green hydrogen, falling renewable power costs will narrow the gap. Attention, meanwhile, must shift to the second-largest cost component, electrolyzers.

This report explores strategies and policies to drive innovation, cut costs for electrolyzers and make green hydrogen a least-cost solution wherever needed. With larger production facilities, design standardisation and insights from early adopters, the proposed strategies could cut costs by 40% in the short term and up to 80% in the long term, this study finds.

In price terms, the resulting green hydrogen could fall below USD 2 per kilogram mark – low enough to compete – within a decade. This opens the way for large-scale manufacturing capacity, new jobs and economic growth. Already, green hydrogen's improving cost projections represent an amazing step forward; until just a few months ago, such results were not expected before mid-century. But getting there depends on defining the right business model, creating markets, and optimising the supply chain in a way that both developed and developing countries, equally, can enjoy the transition to a clean, resilient energy system.

Just as I hope 2021 will be a better year for humanity, I hope these findings will help to inspire the necessary action on green hydrogen. IRENA stands ready to help its member countries worldwide, whatever their energy challenges or level of economic development, make the leap.

Francesco La Camera

Director-General, IRENA

CONTENTS

EXECUTIVE SUMMARY	8
ABOUT THIS REPORT	14
1. INTRODUCTION	15
1.1 Hydrogen and renewables	15
1.2 Latest hydrogen policy developments	18
2. ELECTROLYSER TECHNOLOGY CHARACTERISATION	26
2.1 Electrolyser technologies	31
2.2 Cell level for each type of electrolyser	33
2.3 System level for each type of electrolyser	34
2.4 Trade-offs to consider in the design of the electrolyser	42
2.5 Flexibility of green hydrogen production facilities	46
2.6 Costs: Current status	50
3. STRATEGIES FOR COST REDUCTION: STACK LEVEL	56
3.1 Stack design: What can be done?	57
3.2 Setting targets for stack design: A key performance indicator (KPI)driven approach	64
3.3 Materials: Use, barriers and solutions	67
3.4 Increasing module size	71
4. STRATEGIES FOR COST REDUCTION: SYSTEM LEVEL	73
4.1 Manufacturing scale of electrolyzers	75
4.2 Learning-by-doing	77
5. GREEN HYDROGEN PROJECT PIPELINE	82
5.1 Key players	82
5.2 Current relevant projects and expected key H ₂ production sites beyond 2020	84
6. THE ROAD TO SCALING UP GREEN HYDROGEN: A MILESTONE-DRIVEN APPROACH	86
7. CONCLUSIONS AND ROLE FOR MULTIPLE STAKEHOLDERS IN SCALING UP	92
REFERENCES	97
ABBREVIATIONS	102

FIGURES

Figure 1. Hydrogen production cost as a function of investment, electricity price and operating hours.	18
Figure 2. Recent hydrogen policies and strategies.	20
Figure 3. Electrolyser capacity comparison between national strategies and IRENA's scenarios for 2030.	22
Figure 4. Basic components of water electrolysers at different levels.	28
Figure 5. Challenges and technological breakthroughs for each of the generation of electrolysers.	29
Figure 6. Different types of commercially available electrolysis technologies.	31
Figure 7. Typical system design and balance of plant for an alkaline electrolyser.	34
Figure 8. Typical system design and balance of plant for a PEM electrolyser.	35
Figure 9. Typical system design and balance of plant for an AEM electrolyser.	36
Figure 10. Typical system design and balance of plant for a solid oxide electrolyser.	36
Figure 11. Energy losses for compression in a pressurized electrolyser as a function of delivery pressure and thickness of membrane.	37
Figure 12. Energy losses for the multi-stage mechanical compression of hydrogen.	38
Figure 13. Plot size for an alkaline 1-GW electrolyser plant (left) and for a 100-MW alkaline electrolyser from Thyssenkrupp (right)	41
Figure 14. Trade-offs between efficiency, durability and cost for electrolysers.	42
Figure 15. System schematic for green hydrogen production facility that includes electricity and hydrogen storage on site.	46
Figure 16. Power system services that can be provided by energy storage	48
Figure 17. Seasonality of hydrogen production in Europe in the IRENA global power system model for 2050 (based on the Transforming Energy Scenario).	48
Figure 18. Cost breakdown for a 1-MW PEM electrolyser, moving from full system, to stack, to CCM.	52
Figure 19. System components for a 1-MW PEM electrolyser classified based on contribution to total system cost and potential for cost reduction.	53
Figure 20. Cost breakdown for 1-MW alkaline electrolyser, moving from full system, to stack, to MEA.	54
Figure 21. System components for a 1-MW alkaline electrolyser classified based on contribution to total system cost and potential for cost reduction.	55
Figure 22. Relationship between voltage (the higher, the lower the efficiency) and current density (the higher, the higher the production volume) for various diaphragm thickness of alkaline electrolysers.	58
Figure 23. Global warming potential and cumulative energy demand for critical materials used in electrolysers.	67
Figure 24. Top producers of critical materials in electrolysers.	69
Figure 25. Cost breakdown by major component for alkaline electrolysers based on current costs.	71
Figure 26. Electrolyser investment cost as a function of module size for various technologies.	72
Figure 27. Cost breakdown for PEM electrolysers as a function of manufacturing scale (units of 1 MW per year).	74

Figure 28. Cost breakdown for PEM electrolyzers for a (a) 10 MW/year; (b) 1 GW/year production scale.	76
Figure 29. Potential cost decrease for electrolyzers based on a learning rate and costs achieved by deployment in IRENA scenarios by 2030 and 2050.	79
Figure 30. Variable learning rate based on components for three types of electrolyzers.	81
Figure 31. (a) Historical and (b) Future (based on announcements and projects) electrolyser capacity.	84
Figure 32. Estimated necessary electrolyser manufacturing capacity (GW/year) to meet different installed capacity targets by 2050	85
Figure 33. Milestones for four cost reduction strategies across three stages of deployment for electrolyzers.	87
Figure 34. Potential cost reduction by implementing strategies presented in this report across three stages of deployment.	90
Figure 35. Step changes for achieving green hydrogen competitiveness.	91
Figure 36. Main actions and functions for key stakeholders influencing the scale up of green hydrogen.	93

TABLES

Table 1. Characterisation of the four types of water electrolyzers.	32
Table 2. Proposed activities to improve the performance of alkaline electrolyzers.	59
Table 3. Proposed activities to improve the performance of PEM electrolyzers.	61
Table 4. Proposed activities to improve the performance of AEM electrolyzers.	62
Table 5. Proposed activities to improve the performance of solid oxide electrolyzers.	63
Table 6. Stateofheart and future KPIs for all electrolyser technologies.	65
Table 7. Iridium and platinum loading for PEM electrolyzers with increased performance and material reduction strategies.	70
Table 8. Economies of scale for PEM stack manufacturing.	75
Table 9. Learning rate estimates for electrolyzers and fuel cells.	78
Table 10. Learning rate by stack component for three types of electrolyzers.	80
Table 11. A nonexhaustive list of key players involved in the manufacturing of water electrolyser systems.	83

BOXES

Box 1. A brief look at the historical development of electrolyzers	29
---	----

EXECUTIVE SUMMARY

As more countries pursue deep decarbonisation strategies, hydrogen will have a critical role to play. This will be particularly so where direct electrification is challenging and in harder-to-abate sectors, such as steel, chemicals, long-haul transport, shipping and aviation. **In this context, hydrogen needs to be low carbon from the outset and ultimately green** (produced by electrolysis of water using renewable electricity).

In addition to regulations and market design, the cost of production is a major barrier to the uptake of green hydrogen. Costs are falling – largely due to falling renewable power costs – but green hydrogen is still 2-3 times more expensive than blue hydrogen (produced from fossil fuels with carbon capture and storage) and further cost reductions are needed.¹

The largest single cost component for on-site production of green hydrogen is the cost of the renewable electricity needed to power the electrolyser unit. This renders production of green hydrogen more expensive than blue hydrogen, regardless of the cost of the electrolyser. **A low cost of electricity is therefore a necessary condition for producing competitive green hydrogen.** This creates an opportunity to produce hydrogen at locations around the world that have optimal renewable resources, in order to achieve competitiveness.²

Low electricity cost is not enough by itself for competitive green hydrogen production, however, and **reductions in the cost of electrolysis facilities are also needed.** This is the second largest cost component of green hydrogen production

and is the focus of this report, which identifies key strategies to **reduce investment costs for electrolysis plants from 40% in the short term to 80% in the long term.** These strategies range from the fundamental design of the electrolyser stack to broader system-wide elements, including:

- **Electrolyser design and construction:** Increased module size and innovation with increased stack manufacturing have significant impacts on cost. Increasing the plant from 1 MW (typical today) to 20 MW could reduce costs by over a third. Cost, however, is not the only factor influencing plant size, as each technology has its own stack design, which also varies between manufacturers. The optimal system design also depends on the application that drives system performance in aspects such as efficiency and flexibility.
- **Economies of scale:** Increasing stack production to automated production in GW-scale manufacturing facilities can achieve a step-change cost reduction. At lower manufacture rates, the stack is about 45% of the total cost, yet at higher production rates, it can go down to 30%. For Polymer Electrolyte Membrane (PEM) electrolysers, the tipping point seems to be around 1 000 units (of 1 MW) per year, where this scale-up allows an almost 50% cost reduction in stack manufacturing. The cost of the surrounding plant is as important as the electrolyser stack and savings can be achieved through standardisation of system components and plant design.

¹ In the context of decarbonisation, hydrogen produced from fossil fuels without capturing most of the CO₂ emissions does not fulfil the criteria of renewable energy, although it represents the vast majority of hydrogen production today.

² The trend over the last decade of falling renewable electricity prices is expected to continue; 82%, 47% and 39% for solar photovoltaic (PV), offshore and onshore wind respectively (IRENA, 2020a).

- **Procurement of materials:** Scarce materials can represent a barrier to electrolyser cost and scale-up. Current production of iridium and platinum for PEM electrolysers will only support an estimated 3 GW-7.5 GW annual manufacturing capacity, compared to an estimated annual manufacturing requirement of around 100 GW by 2030. Solutions that avoid the use of such materials are already being implemented by leading alkaline electrolyser manufacturers, however, and technologies exist to significantly reduce the requirements for such materials in PEM electrolysers. Anion Exchange Membrane (AEM) electrolysers do not need scarce materials in the first place.
- **Efficiency and flexibility in operations:** Power supply represents large efficiency losses at low load, limiting system flexibility, from an economic perspective. A modular plant design with multiple stacks and power supply units can address this problem. Compression could also represent a bottleneck for flexibility, since it might not be able to change its production rate as quickly as the stack. One alternative to deal with this is an integrated plant design with enough capacity to deal with variability of production through optimised and integrated electricity and hydrogen storage. Green hydrogen production can provide significant flexibility for the power system, if the value of such services is recognised and remunerated adequately. Where hydrogen will play a key role in terms of flexibility, as it does not have any significant alternative sources to compete with, will be in the seasonal storage of renewables. Although this comes at significant efficiency losses, it is a necessary cornerstone for achieving 100% renewable generation in power systems with heavy reliance on variable resources, such as solar and wind.
- **Industrial applications:** Electrolysis system design and operation can be optimised for specific applications. These can range from: large industry users requiring a stable supply and with low logistics costs; large scale, off-grid facilities with access to low-cost renewables, but that incur in significant costs to deliver hydrogen to the end-user; and decentralised production that requires small modules for flexibility, which compensate for higher investment per unit of electrolyser capacity with reduced (or near-zero onsite) logistic costs.
- **Learning rates:** Several studies show that potential learning rates for fuel cells and electrolysers are similar to solar PV and can reach values between 16% and 21%. This is significantly lower than the 36% learning rates experienced over the last 10 years for PV (IRENA, 2020a). With such learning rates and a deployment pathway in line with a 1.5°C climate target, a reduction in the cost of electrolysers of over 40% may be achievable by 2030.

Figure ES1 shows how up to **85% of green hydrogen production costs can be reduced in the long term** by a combination of cheaper electricity and electrolyser capex investment, in addition to increased efficiency and optimised operation of the electrolyser.

Figure ES1. A combination of cost reductions in electricity and electrolyzers, combined with increased efficiency and operating lifetime, can deliver 80% reduction in hydrogen cost.

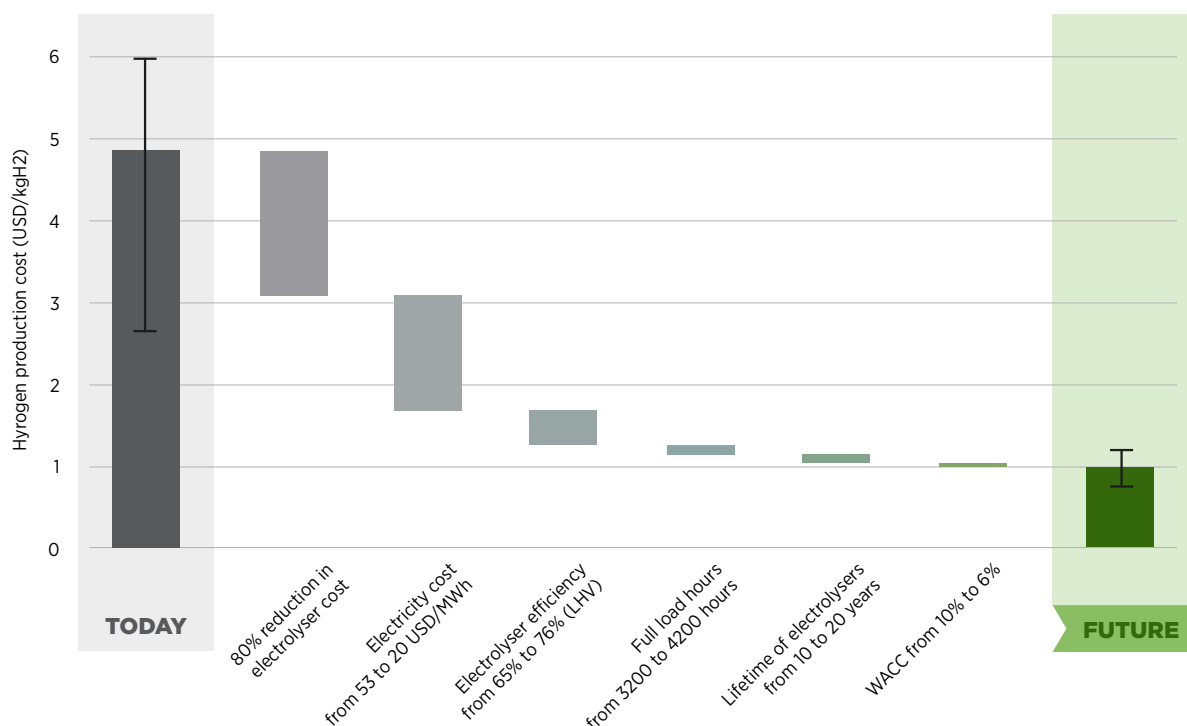

Note: ‘Today’ captures best and average conditions. ‘Average’ signifies an investment of USD 770/kilowatt (kW), efficiency of 65% (lower heating value – LHV), an electricity price of USD 53/MWh, full load hours of 3200 (onshore wind), and a weighted average cost of capital (WACC) of 10% (relatively high risk). ‘Best’ signifies investment of USD 130/kW, efficiency of 76% (LHV), electricity price of USD 20/MWh, full load hours of 4200 (onshore wind), and a WACC of 6% (similar to renewable electricity today).

Based on IRENA analysis

Figure ES2 illustrates the potential green hydrogen production cost reduction between 2020 and 2050 for a range of electrolyzers cost and deployment levels. **In the best-case scenario, green hydrogen can already be produced at costs competitive with blue hydrogen today**, using low-cost renewable electricity, *i.e.* around USD 20 per megawatt-hour (MWh).

A low electricity price is essential for the production of competitive green hydrogen, and, as illustrated in Figure ES2, cost reductions in electrolyzers cannot compensate for high electricity prices. Combined with low electricity cost, an aggressive electrolyser deployment pathway³ can make green hydrogen cheaper than any low-carbon alternative (*i.e.* <USD1/kg), before 2040. If rapid scale-up takes place in the next decade, green hydrogen is expected to start becoming competitive with blue hydrogen by 2030 in a wide range of countries – *e.g.* those with electricity prices of USD 30/MWh – and in applications.

3 Meaning 5 terawatts (TW) of installed capacity by 2050.

Figure ES2. Cost of green hydrogen production as a function of electrolyser deployment, using an average (USD 65/MWh) and a low (USD 20/MWh) electricity price, constant over the period 2020-2050.

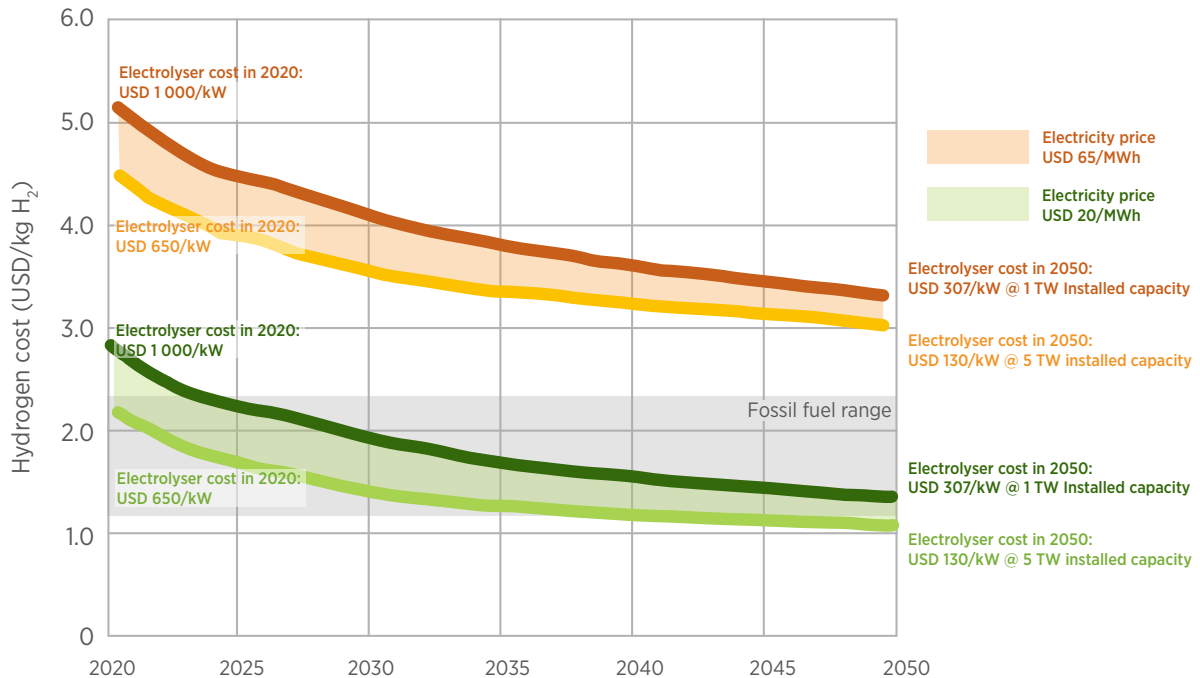

Note: Efficiency at nominal capacity is 65%, with a LHV of 51.2 kilowatt hour/kilogramme of hydrogen (kWh/kg H₂) in 2020 and 76% (at an LHV of 43.8 kWh/kg H₂) in 2050, a discount rate of 8% and a stack lifetime of 80 000 hours. The electrolyser investment cost for 2020 is USD 650-1000/kW. Electrolyser costs reach USD 130-307/kW as a result of 1-5 TW of capacity deployed by 2050.

Based on IRENA analysis.

Today's cost and performance are not the same for all electrolyser technologies (see Table ES1). Alkaline and PEM electrolysers are the most advanced and already commercial, while each technology has its own competitive advantage. Alkaline electrolysers have the lowest installed cost, while PEM electrolysers have a much smaller footprint, combined with higher current density and output pressure. Meanwhile, solid oxide has the highest electrical efficiency. As the cell stack is only part of the electrolyser facility footprint, a reduced stack footprint of around 60% for PEM compared to alkaline translates into a 20%-24% reduction in the facility footprint, with an estimated

footprint of 8 hectares (ha)-13 ha for a 1 GW facility using PEM, compared to 10 ha-17 ha using alkaline (ISPT, 2020). **Gaps in cost and performance are expected to narrow over time as innovation and mass deployment of different electrolysis technologies drive convergence towards similar costs.** The wide range in system costs is expected to remain, however, as this is very much dependent on the scale, application and scope of delivery. For instance, a containerised system inside an existing facility with existing power supply is significantly lower cost than a new building in a plot of land to be purchased, with complete water and electricity supply system to be included, high purity

hydrogen for fuel cell applications and high output pressure. Normally, numbers for system costs include not only cell stack, but also balance of stacks, power rectifiers, the hydrogen purification system, water supply and purification, cooling and commissioning – yet exclude shipping, civil works and site preparations.

Notably, the numbers for 2020 are cost estimates for a system ordered in 2020, representing the

lowest value the price can be (on the limit of zero profit). As the market scales up rapidly, in the initial phase, the investment in manufacturing facilities must be recovered, therefore the gap between cost and price is currently higher than in 10 or 20 years from now. As a reference, an estimated investment of EUR 45-69 million is required for each GW of manufacturing capacity (Cihlar et al., 2020).

Table ES1. Key performance indicators for four electrolyser technologies today and in 2050.

	2020				2050			
	Alkaline	PEM	AEM	SOEC	Alkaline	PEM	AEM	SOEC
Cell pressure [bara]	< 30	< 70	< 35	< 10	> 70	> 70	> 70	> 20
Efficiency (system) [kWh/KgH ₂]	50-78	50-83	57-69	45-55	< 45	< 45	< 45	< 40
Lifetime [thousand hours]	60	50-80	> 5	< 20	100	100-120	100	80
Capital costs estimate for large stacks (stack-only, > 1 MW) [USD/kW _{el}]	270	400	-	> 2 000	< 100	< 100	< 100	< 200
Capital cost range estimate for the entire system, >10 MW [USD/kW _{el}]	500-1000	700-1400	-	-	< 200	< 200	< 200	< 300

Note: PEM = Polymer Electrolyte Membrane (commercial technology); AEM = Anion Exchange Membrane (lab-scale today); SOEC = Solid Oxide Electrolysers (lab-scale today).

Based on IRENA analysis.

Innovation is crucial to reduce cost and improve the performance of the electrolyser. The ultimate goals are to: 1) reduce cost by standardising and simplifying manufacturing and design to allow for industrialisation and scale-up; 2) improve efficiency to reduce the amount of electricity required to produce one unit of hydrogen; and 3) increase durability to extend the equipment lifetime and spread the cost of the electrolyser facility over a larger hydrogen production volume.

Governments can support innovation in electrolysers by issuing clear long-term signals that support policy on:

- Facilitating investment in production, logistics and utilisation of green hydrogen, including all areas that will help this low-carbon energy carrier to become competitive; technology cost and performance improvements, material supply, business models and trading using common standards and certifications.
- Establishing regulations and design markets that support investments in innovation and scale-up the production of green hydrogen. This includes approaches such as setting manufacturing or deployment targets, tax incentives, mandatory quotas in hard to decarbonise sectors and other de-risking mechanisms, while enabling new business models that can guarantee predictable revenues for the private sector to invest at scale.
- Supporting research, development and demonstration (RD&D) to: reduce the use of iridium and platinum in the manufacture of PEM electrolysers; transition all alkaline units to be platinum- and cobalt-free; and, in general, mandate reduced scarce materials utilisation as a condition for manufacturing scale-up.
- Fostering coordination and common goals along the hydrogen value chain, across borders, across relevant sectors and between stakeholders.

ABOUT THIS REPORT

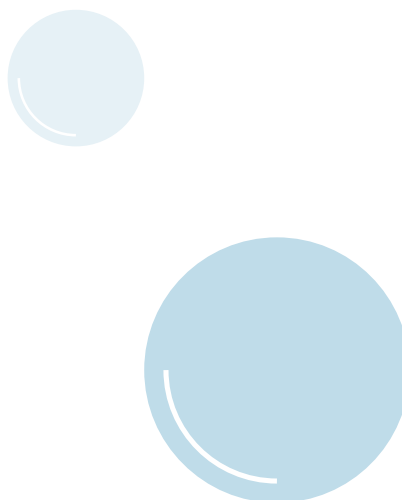

This report is part of IRENA's ongoing programme of work to provide its member states and the wider community with expert analytical insights into the potential options and enabling conditions and policies that could deliver deep decarbonisation of economies.



This report complements a range of publications and activities produced and planned by IRENA, including its annual Global Renewable Outlook, which provides detailed global and regional roadmaps for emission reductions alongside assessment of the socio-economic implications. The 2020 edition includes Deep Decarbonisation Perspectives, detailing options for net-zero or zero emissions (IRENA, 2020b). The next edition is expected to include further detailed analysis of a pathway consistent with a 1.5°C goal.

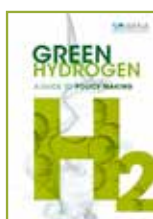

Building on that technical and socio-economic assessment, IRENA is assessing specific facets of that pathway, including the policy and financial frameworks needed. This includes the roles of direct and indirect electrification, the implications for power systems, the role of green hydrogen and of biomass, and options for specific, challenging end-use sectors.



For green hydrogen, some of the relevant **recent and upcoming publications** include: *Hydrogen: A renewable energy perspective* (IRENA, 2019a); the *Reaching Zero with Renewables* report and its briefs on industry and transport (IRENA, 2020c); the *Green Hydrogen: A guide to policy making* report and its associated briefs (IRENA, 2020d), which present a policy framework to promote green hydrogen across the entire energy sector and the key overarching policy pillars; reports on the potential of biojet fuels and on renewable methanol; *Renewable energy policies in a time of transition: Heating and Cooling*, and the subsequent briefs to this report (IRENA, 2020e).

This analytical work is complemented by IRENA's work to convene experts and stakeholders, including IRENA's Innovation Weeks, Policy Days and Policy Talks and IRENA's Collaborative Framework on Green Hydrogen, which brings together a broad range of member states and other stakeholders to exchange knowledge and experience.

Details of these and other related activities can be found at www.irena.org.

1.

INTRODUCTION

KEY POINTS

- The major cost component for green hydrogen is the electricity supply. Cost decline in this is already underway through the competitive deployment of renewables.
- There is a need to focus on reducing the procurement and construction cost and increasing the performance and durability of electrolyzers, to achieve further cost reductions in green hydrogen production.
- Green hydrogen can achieve cost-competitiveness with fossil-based hydrogen today in ideal locations with the lowest renewable electricity costs. Cost reductions in renewable electricity and electrolyzers will continue to increase the number of sites where green hydrogen can be produced competitively, however.
- Policy support in recently unveiled hydrogen strategies in many countries is mostly in the form of explicit electrolyser capacity targets and, to a more limited extent, cost targets. These have yet to translate into specific regulatory instruments. So far, these explicit targets are not enough to be in line with 1.5°C decarbonisation pathways.

1.1 HYDROGEN AND RENEWABLES

The world is undergoing a dramatic change in the way energy is produced, transformed, stored and used in its various forms. People are becoming increasingly conscious of the need to move

towards a society where energy stops contributing to climate change and local pollution, replacing fossil fuels with renewable energy.

As the deployment of renewable energy sources increases all over the globe in the power sector, solutions that leverage renewable electricity to decarbonise end-use sectors using power-to-gas strategies, or to convert electricity into high-value chemicals or fuels, need to be quickly introduced (IRENA, 2020c). In addition, as electricity needs to increase from around 20% of final energy consumption to around 50% by 2050 (IRENA, 2020b), there is still a need to decarbonise applications for which direct electrification is more challenging (the so called “hard-to-abate” sectors).

Hydrogen is only one option in decarbonising hard-to-abate sectors. Energy efficiency is key to reducing the energy supply and renewable capacity upstream, while bioenergy might be suitable, not only in the form of biofuels for those transport sectors that have limited fuel alternatives (especially aviation), but also as a source of carbon for synthetic fuels. Direct electrification is more efficient from a systems perspective, leading to lower cost, with this already commercially deployed in many areas (e.g. heating or passenger vehicles). Carbon capture and storage (CCS) might be attractive for existing assets that are still in early stages of their lifetime (the case for many assets in Asia) and process emissions (e.g. from cement production). Even for the most ambitious scenarios, these technological choices might not be enough, however, and behavioural changes might be needed to push energy demand even lower. Thus, for energy transition, hydrogen is one solution amongst others and should be tackled in parallel. Hydrogen is part of a wider technology portfolio to be adapted to domestic conditions in each country, with this report further exploring this pathway.

Green hydrogen (*i.e.* hydrogen produced from renewable electricity) links renewable electricity with a range of end-use applications acting as a complement of electrification, bioenergy and direct renewable energy use (IRENA, 2018). The potential for green hydrogen is much higher than fossil fuels, since it is linked to solar and wind potential, which far exceeds global energy demand today and in any future scenario. Most importantly, in the

context of decarbonisation, green hydrogen is the only zero-carbon option for hydrogen production, as carbon capture in CCS is 85%-95% at best and significantly lower to date.

Once produced at scale and competitive cost, green hydrogen can also be further converted into other energy carriers, such as ammonia, methanol, methane and liquid hydrocarbons. As a fuel, hydrogen can be used in fuel cells (*i.e.* an electrochemical device that combines hydrogen with oxygen from the air and produces electricity), but also combusted in engines and turbines. Fuel cells can be used for stationary applications in large-scale power plants, microgrid or backup generation (e.g. in data centres), or for a wide range of transport applications – as is already done in fuel cell electric vehicles (FCEV), trucks, light-duty vehicles, forklifts, buses, ferries and ships. As a chemical, green hydrogen can reduce greenhouse gas (GHG) emissions from sectors where hydrogen from fossil fuel is widely used today, including oil refining, methanol and ammonia production.

Green hydrogen is only one of the production pathways. Hydrogen can also be produced from bioenergy, methane, coal or even directly from solar energy. Most of the production today is based on methane and coal (about 95%) (IRENA, 2019a) and could be made low carbon with the use of CCS. CCS might be suitable for regions with low-cost natural gas and suitable underground reservoirs. In the short term, CCS might also be a good fit for large-scale applications in industry, given the relatively small scale of deployment for electrolysis.

Low-carbon hydrogen can also be produced from methane pyrolysis, where the carbon ends up as solid rather than as CO₂, with 4-5 times lower electricity consumption than electrolysis and potentially lower hydrogen production cost. Each pathway has its own limitations. Bioenergy might be best suited for other applications, considering its limited nature and the low inherent hydrogen yield. CCS does not lead to zero emissions, requires significant infrastructure for the CO₂, does not enable sector coupling, is still exposed to the price fluctuations characteristic of fossil fuels, and

could face social acceptance issues. In addition, methane leakages associated with production and transportation of the gas have been increasingly under scrutiny as significant contributors to the acceleration of climate change. Methane has 86 times higher global warming potential compared to CO₂ over a 20-year time horizon (The CCAC Oil & Gas Methane Partnership, no date; Hmiel et al., 2020). Pyrolysis is still at the pilot scale stage and would require high-temperature renewable or low-carbon heat. Hence, considering the sector, green hydrogen is one of the most attractive options, given its nature and renewable character, and as such, it is the focus of this report.

Green hydrogen, similar to other production pathways, also has its challenges, however. These include: its current high cost across the entire value chain, from electrolysis to transport and fuel cells; the lack of existing infrastructure for transport and storage; the high energy losses (which in turn require higher wind/solar deployment rates); and the lack of value for the main benefit (e.g. lower GHG emissions) that green hydrogen can have (IRENA, 2019a, 2020c).

Electricity is the dominant cost for on-site production of green hydrogen, but the journey to lower renewable costs is already underway. Efforts need to shift to the second largest cost for green hydrogen: electrolyzers

Renewables are becoming the cheapest source of electricity around the world, with significant potential for further cost reductions (IRENA, 2020a). This opens up the opportunity, in the long-term, to trade globally low-cost green hydrogen from the best renewable resources to regions with limited land or renewable potential. This trade can be done directly with liquid hydrogen, in the form of hydrogen carriers that increase the energy density for transport, or in the form of commodities (e.g. reduced iron and chemicals). The missing element in this equation is the key facility to convert renewable power into green

hydrogen: the electrolyser. Electrolysers are the technology necessary to produce hydrogen using electricity and water as inputs. Electrolysis is a well-established technology that is deployed mostly in the chemical industry. While scale-up is needed to bring costs down, technological innovation is also needed to further improve the performance of the technology (*i.e.* its efficiency and lifetime). This can be done via new catalysts and configurations, the standardisation of designs and a move to mass production of the equipment.

Green hydrogen is already close to being competitive today in regions where all the favourable conditions align, but these are usually far from demand centres. For example, in Patagonia, wind energy could have a capacity factor of almost 50%, with an electricity cost of USD 25-30/MWh. This would be enough to achieve a green hydrogen production cost of about USD 2.5/kg, which is close to the blue hydrogen cost range. In most locations, however, green hydrogen is still 2-3 times more expensive than blue hydrogen. The cost of the former is defined by electricity costs, investment cost, fixed operating costs and the number of operating hours of the electrolyser facilities (see Figure 1).

With low operating hours, the investment cost dominates, as it is spread over a smaller amount of hydrogen. This could happen when using only curtailed electricity, or coupling with PV without any storage or backup. The electricity cost becomes dominant as the number of operating hours increases. Solar projects in countries such as Brazil, Portugal, the United Arab Emirates and the United States have been deployed with costs of electricity as low as USD 13.5-20/MWh due to supportive policy instruments, such as auctions, to guarantee a stable payment and reduce the investment risk.

Due to the efficiency of the current process, any power cost that goes into the process translates into roughly 1.5 times this value in final production costs. This means that a power cost of USD 20/MWh results in around USD 31/MWh in the final cost of the hydrogen, or a figure slightly above USD 1/kg H₂.

Under the optimal conditions of low-cost renewable electricity, low investment cost (achievable through the strategies suggested in this report) and a high number of operating hours, green hydrogen could achieve cost competitiveness with fossil-based hydrogen, noting that only about 3000-4000 hours per year may be enough to achieve the largest reduction in the contribution of the investment. This can be achieved by, for instance, large scale hybrid PVwind plants, which, at the best locations in the world, can achieve capacity factors above 5000 hours.

Currently, green hydrogen production is limited to demonstration projects. By September 2020, there were almost 320 of these, adding up to around 200 MW of electrolyser capacity (IEA TCP). Green hydrogen (through water electrolysis) contributed to less than 0.02% of presentday global pure hydrogen production. Projects are mostly in the single-digit MW scale with the largest project in operation currently a 10 MW alkaline electrolyser in Japan. A 20 MW PEM electrolyser in Becancour (Canada) by Air Liquide is expected to be operational before the end of 2020. In spite of this small scale, the technology is already commercial and ready to scale up, with projects announced between 2020 and 2025 adding up to more than 25 GW and new projects being announced on almost a weekly basis (see Chapter 5, Section 2).

Figure 1. Hydrogen production cost as a function of investment, electricity price and operating hours.

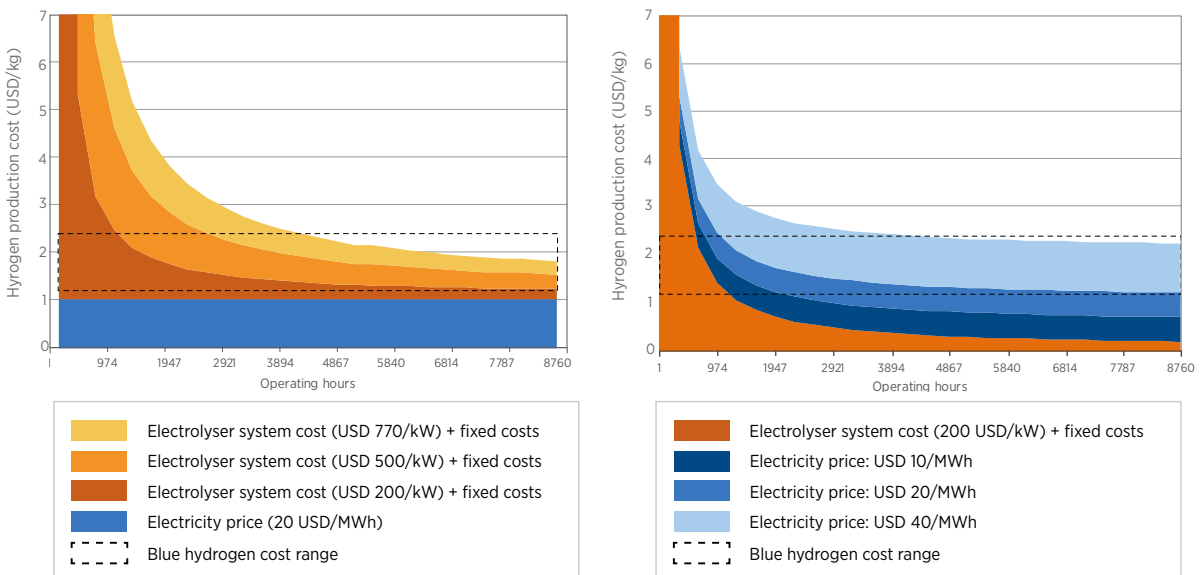

Note: Efficiency at nominal capacity is 65% (with an LHV of 51.2 kWh/kg H₂), the discount rate 8% and the stack lifetime 80 000 hours.

Based on IRENA analysis.

1.2 LATEST HYDROGEN POLICY DEVELOPMENTS

Previous waves of interest in hydrogen have been triggered by oil supply shocks, with this technology seen as a way to diversify away from oil and improve energy security. In recent years, with the focus on net zero emissions and plummeting renewable costs, interest in other sectors has become more prominent. As a consequence, most of the existing policy support for hydrogen is for fuel cell electric vehicles and refuelling stations (IRENA, 2020d). This is set to change in the coming years as focus changes to sectors with existing hydrogen demand (industry) and replacement of fossil-based hydrogen.

Promoting hydrogen uptake across the various end-use sectors requires an integrated policy approach. The main pillars of this are: national hydrogen strategies that bring all the elements together, set a long-term vision shared with industry and guide efforts from multiple stakeholders; setting policy priorities for sectors where hydrogen could add the most value according to national conditions; governance systems and enabling policies that remove barriers and facilitate growth; guarantees of origin systems to track production emissions and be able to value the lower GHG emissions (IRENA, 2019a, 2020c).

Over the last few years, an increasing number of countries have adopted hydrogen policies and strategies. These differ in scope (e.g. with a focus on green hydrogen, fossil-based, or a combination of the two) and scale (from no targets to very ambitious, quantified hydrogen as well as electrolyser targets). What emerges clearly from this rapid increase in the number and ambition

of hydrogen policies in such a short period of time is the widespread recognition that in order to achieve the objectives of the Paris Agreement, green hydrogen has a key role to play in reaching zero emissions from the energy sector (IRENA, 2020b, 2020c).

While some strategies support fossil-based hydrogen in the short-term, as a transitional technology for scaling up, there is widespread support for green hydrogen as the long-term, sustainable solution. Support is also more widespread today, with more countries supporting green hydrogen compared to blue. Amongst countries that support only one technological pathway, there are also more supporting only green hydrogen than only blue. As recently as 2020, eight jurisdictions around the world announced hydrogen strategies and at least ten more are expected in 2021. These strategies, however, are neither the beginning nor the end of the role of hydrogen in decarbonising energy. They are the result of investment, starting in the 1970s, in energy application research and development (R&D) that has enabled technological progress and close cooperation between private and public actors. This has taken place through partnerships, culminating in vision documents or roadmaps that pave the way for more concrete policy actions by aligning long-term views. These strategies are not the end of the process, however, since they must be followed by impact assessments, policy design, financial viability and implementation. In the last two years, though, there has been a significant increase in public efforts towards achieving these goals (see Figure 2).

Figure 2. Recent hydrogen policies and strategies.

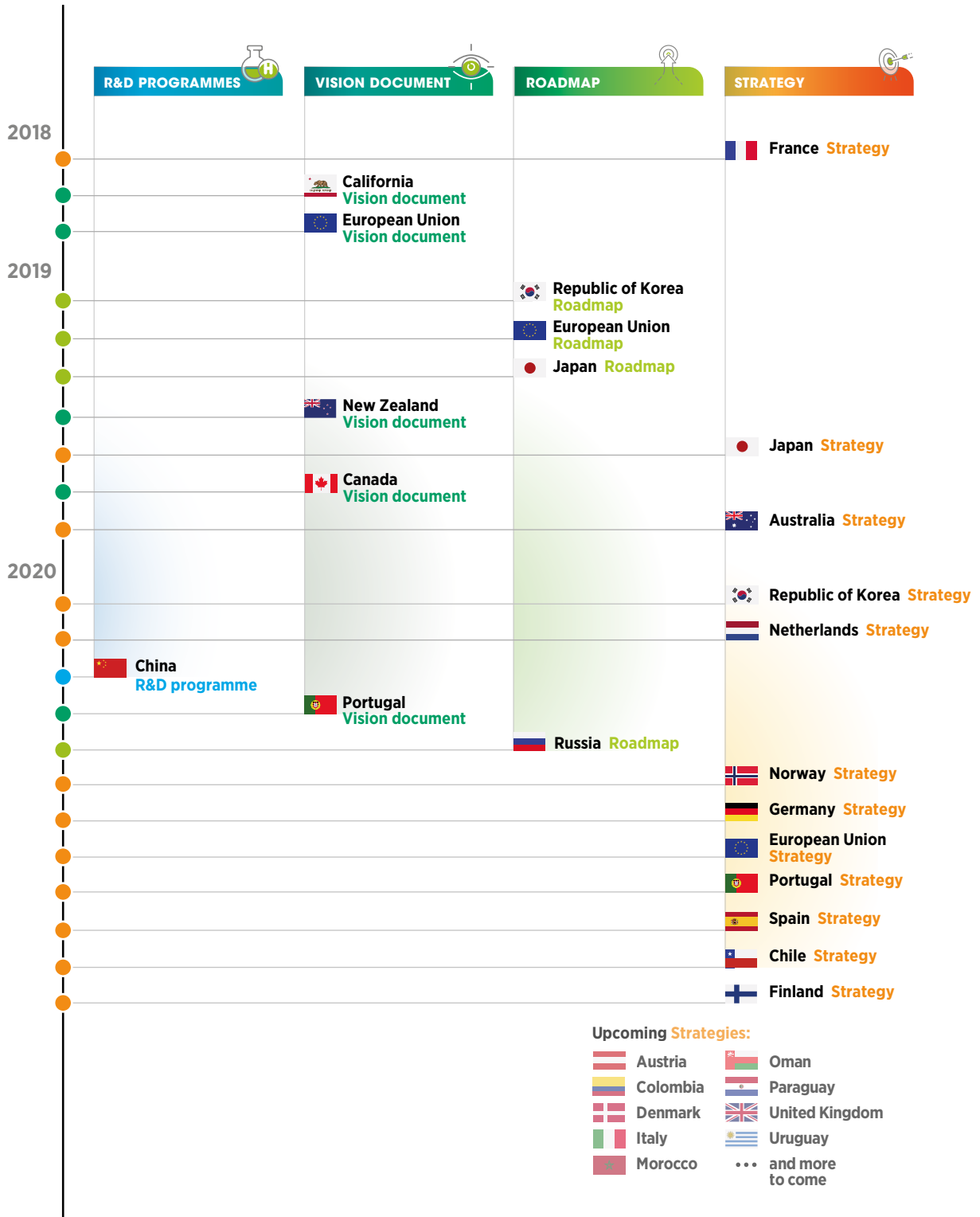

Source: (IRENA, 2020d).

Today, most countries are at the strategy stage and have yet to move to concrete policy measures. Explicit capacity targets for electrolysis are the most common measure for green hydrogen and have been the norm across Europe (see below). Specific policy instruments to achieve those targets will only be crafted over the coming months. For example, Japan was one of the earlier supporters of hydrogen and has already translated its strategy into concrete cost and efficiency targets per application. Japan also already has multiple projects underway for international trade in hydrogen (import is a large part of their strategy) with the first liquid hydrogen ship having been delivered in December 2019 and the first blue ammonia (*i.e.* ammonia from gas reforming with CCS) shipment in September 2020. Meanwhile, Australia and Chile have opted for ambitious cost targets instead. Australia has launched the “H₂ under 2” target (production cost below AUD 2/kg of hydrogen), which has already triggered AUD 370 million in State support (see below) and consideration in the country’s Technology Investment Roadmap, while Chile has set a target of USD 1.5/kg of hydrogen by 2030, aiming to become the cheapest in the world.

Beyond capacity and cost targets, other possibilities are available to governments, including incentives for the domestic production of electrolyzers (*e.g.* tax breaks), direct grants, conditional and convertible loans, feed-in tariffs, auctions and contracts for difference, amongst others. Nevertheless, these have insofar been limited in the strategies announced. IRENA has explored trade-offs to consider the design of these policy instruments in a separate publication (IRENA, 2020d).

The most ambitious strategies for green hydrogen are in the European Union (EU). The EU as a whole has a target of 40 GW⁴ by 2030, which is supported by national targets from France, Germany, Netherlands, Portugal and Spain. These targets are 6.5 GW, 5.0 GW, 3.0-4.0 GW respectively. The EU strategy also sets a target volume of 10 million tonnes of hydrogen per year (MtH₂/year) by

2030, which would require 40 GW of electrolysis in neighbouring countries (North Africa). Beyond the EU plans, Chile has a target of 25 GW by 2030 and Australia has multiple multi-GW proposals ongoing. Both countries are aiming to satisfy local demand in the early stages of development, targeting exports in the long term.

Adding up these three targets for electrolysis would already be enough to satisfy the 2030 target of 100 GW in IRENA’s Planned Energy Scenario. This is, however, not yet compatible with a wellbelow 2°C trajectory, which would require at least 270 GW of capacity deployed by 2030 — as outlined in the Transforming Energy Scenario (TES – see Figure 3). The TES scenario still has about 9.5 gigatonnes of carbon dioxide (GtCO₂) of remaining emissions in 2050. Going further, a net zero world by 2050 would require an even larger role for hydrogen and a faster pace of deployment. On a positive note, 14 of 17 strategies already focus on green hydrogen by 2030, while only the EU (and several of its member states), Chile and Australia set specific electrolysis targets. Therefore, the large gap before the more ambitious scenario could be rapidly closed once the other countries that support green hydrogen set specific targets for electrolysis capacity.

Indeed, the translation of hydrogen production targets into specific electrolyser capacity targets for green hydrogen production is an important element of a national hydrogen strategy. This give the right signal for industry to invest in electrolyser manufacturing plants, while showing the means by which such targets can be achieved (*i.e.* government policies), which are a necessary condition to meet policy targets for green hydrogen. Electrolyser costs will benefit from global deployment, which calls for coordinating national efforts through international platforms to ensure that lessons are being transferred from one country to another.

Just as importantly, green hydrogen production requires significant additional renewable electricity generation, which also requires investment in manufacturing capacity for renewable power generation.

4 Capacities for electrolyzers are based on hydrogen output, throughout this report.

In the absence of such clear policy statements, including on the production pathway for hydrogen (i.e. electrolysis or fossil fuels), the lack of certainty of the demand for electrolysers and additional renewable power generation will slow down

the growth of the green hydrogen sector, which is already very ambitious in absence of supply bottlenecks.

Figure 3. Electrolyser capacity comparison between national strategies and IRENA’s scenarios for 2030.

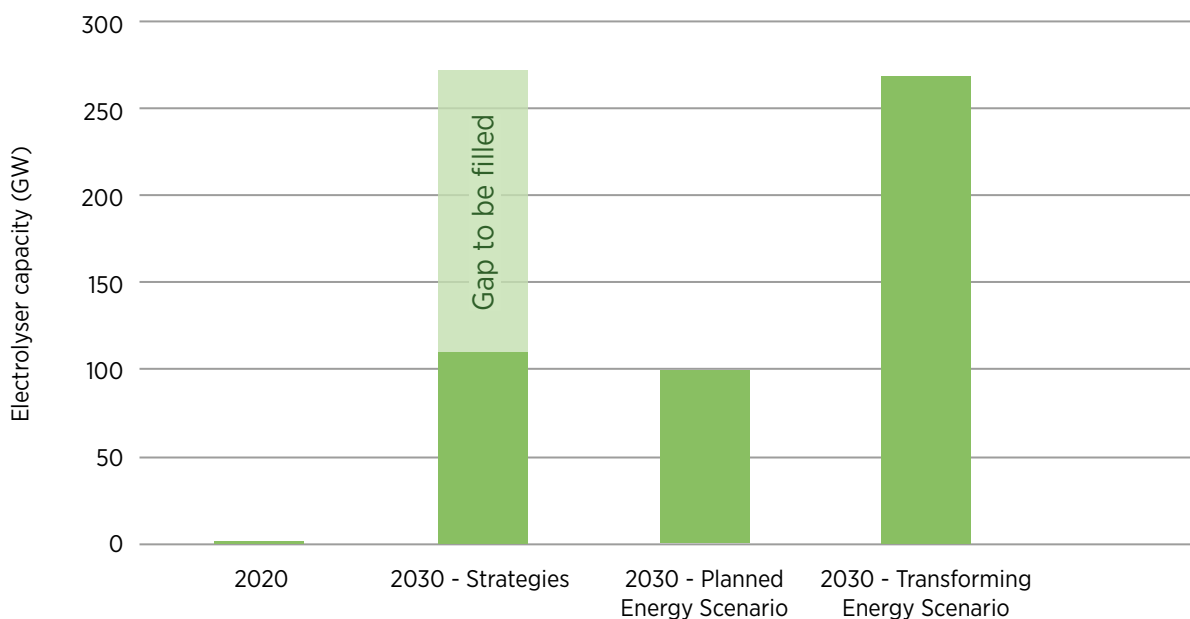

Based on IRENA analysis.

The fulfilment of the strategies announced so far would mean going from around 0.2 GW of water electrolysis today to about 85 GW in 2030 (see Figure 3). This represents an annual growth rate of almost 83% per year. As a reference, solar photovoltaic (PV) almost achieved such a pace in 2008-2011, but did so with a trained workforce in place and policy support (feed-in tariffs), while also being easier to install than electrolysers. This means that investments need to rapidly materialise to allow scale-up of electrolyser manufacturing capacity.

A few selected hydrogen strategies are highlighted here, in particular those with a clear focus on electrolysers scale-up. For a comprehensive overview of hydrogen policies in place and recommendation for hydrogen policy development, as well as a number of insights into strategies to

accelerate its development, refer to previous IRENA reports (IRENA, 2019a, 2020c).

Australia: National hydrogen strategy sets a vision for a clean, innovative, safe and competitive hydrogen industry, with the aim of positioning it as a major player by 2030. The strategy outlines an adaptive approach that equips Australia to scale up quickly as the hydrogen market grows. The strategy includes a set of nationally coordinated actions involving governments, industry and the community. Australia has adopted eight international standards to shape its hydrogen future, as it bids to use the fuel to enhance energy security and build a billion-dollar export industry. The rules have the potential not only to support the safety of users – with guidance on storage, transport and refuelling – but also to facilitate international trade, as the nation aims to assume a major role

in the global hydrogen economy. As mentioned above, one of the key targets is “H₂ under 2”, which targets a production cost of AUD 2/kg (USD 1.4/kg) for hydrogen to be competitive across various applications. By 2019, when the national strategy was launched, the government had committed over AUD 500 million (USD 355 million) towards hydrogen projects. Additionally, the government has announced an investment package of AUD 1.9 billion (USD 1.35 billion) to support new energy technologies, including hydrogen, with AUD 70.2 million (USD 49.8 million) dedicated specifically to hydrogen export hubs (Australian Government, 2020).

Chile: This country has some of the best renewable resources in the world, both in solar (desert in the north) and wind (Patagonia in the south). Electricity costs from solar and wind are expected to fall, from USD 20-30/MWh today to USD 10-20/MWh by mid-century. The renewable potential is attractive, not only in terms of cost, but in quantity. Chile’s renewable potential is equivalent to 70 times today’s electricity generation capacity. Based on this, Chile’s strategy is focused exclusively on green hydrogen and directed towards exports.

Hydrogen deployment in the country is expected in three waves: first, domestic use, replacing fossilbased hydrogen in industry and heavy, longdistance transport; second, ammonia exports, blending into the grid and a larger share of road transport; and third, scale-up of hydrogen exports and production for shipping and aviation. The targets include 5 GW of electrolysis capacity (operating and under development) by 2025 with a production of at least 0.2 MtH₂/year. The targets for 2030 are 25 GW of electrolysis, with a hydrogen production cost less than USD 1.5/kg – the cheapest in the world – and exporting the equivalent of USD 2.5 billion per year of hydrogen and derivatives. To achieve these targets, 15 actions have been identified across four main themes: promotion of domestic and export markets (including international collaboration, knowledge exchange and guarantees of origin); standards, safety and piloting (including market design to allow the participation of electrolyzers in the various markets); social and local development

(social acceptance and infrastructure); capacity building and innovation.

European Union: On July 8, 2020, the European Commission published its hydrogen strategy for a climate neutral Europe. This aims to boost the clean production of hydrogen to be used as a feedstock, fuel, energy carrier, and ultimate storage alternative for European renewables. The drivers for hydrogen are carbon neutrality, job creation, economic growth and technology leadership (especially for electrolyzers). The strategy has explicit electrolyzer capacity targets of 6 GW by 2024 and 40 GW by 2030, as well as production targets of 1 million and 10 million tonnes of renewable hydrogen per year for those two milestone years. Reaching these production targets would require a larger capacity than the 6 GW and 40 GW specified, which implies additional import from neighbouring countries. Investments in renewable hydrogen are estimated to be in the order EUR 220-340 billion (USD 280-430 billion) for the electricity production and EUR 24-42 billion (USD 30.5-53 billion) for the electrolyzers by 2030.

Hydrogen is seen by the European Commission as a key vector across energy sectors and this strategy was released together with a strategy called “Energy System Integration”, highlighting this function. The Clean Hydrogen Alliance (CHA), a platform that brings together multiple stakeholders from industry, government, civil society and academia, was also launched the same day. Besides bringing actors together, the CHA is also meant to provide a robust pipeline of projects that will support the scale-up process. The commission’s economic recovery plan, “Next Generation EU”, highlights hydrogen as an investment priority to boost economic growth and resilience, creating local jobs and consolidating the EU’s global leadership. The total fund is EUR 750 billion (about USD 950 billion) and while only a small share of this is expected to be used for hydrogen, it could represent a large step towards the 2024 goal of 6 GW.

Germany: The federal government of Germany released its hydrogen national strategy in June 2020. Among the drivers for hydrogen it contains

are hydrogen's potential contribution towards GHG neutrality and the need for action in hard-to-abate sectors, along with economic growth and the competitiveness of the domestic industry. Emphasis is given to the industrial and transport sectors. The need for potential hydrogen imports to complement domestic potential is also recognised. The German government will only support hydrogen produced from renewables, hence, it seeks the production and use of green hydrogen by promoting its rapid market rollout and establishing the necessary value chain within the country.

Germany has been a key proponent of hydrogen, having already invested around EUR 700 million (about USD 890 billion) between 2006 and 2016 under the National Innovation Programme in Hydrogen, with a total of EUR 1.4 billion (USD 1.7 billion) in funding set to be provided within its Hydrogen National Strategy, up to 2026. The German government expects that from 90 terawatt hours (TWh) up to 110 TWh of hydrogen will be needed by 2030. In order to cover part of this demand, Germany plans to deploy up to 5 GW of hydrogen generation capacity using water electrolyzers coupled to onshore and offshore wind farms by 2030, with this rising to 10 GW in total by 2035-2040. This corresponds to 14 TWh of green hydrogen production and would require 20 TWh of renewables.

German industry is highly dependent on hydrogen supplies, with more than 80 TWh of green hydrogen expected to be needed for GHG-neutral steel production by 2050. In addition, 22 TWh of demand is expected from German refinery and ammonia production. The EUR 130 billion (about USD 165 billion) economic recovery package proposed as a response to the COVID-19 crisis includes EUR 9 billion (USD 11.4 billion) for hydrogen, out of which, specifically, EUR 2 billion (USD 2.5 billion) will be targeted for international partnerships. Germany already collaborates with countries in North Africa and countries as far away as Australia, in view of the potential global market that can be developed in future.

Japan: This was the first country to adopt a “basic hydrogen strategy” and with specific plans to become a “hydrogen society”. The Japanese strategy primarily aims to achieve cost parity with competing fuels, such as gasoline in the transportation sector or liquefied natural gas (LNG) in power generation. The strategy also covers the entire supply chain, from production to downstream market applications.

Given limited natural resources and limited land availability, hydrogen import plays a key role in the Japanese strategy. The approach has been to pursue parallel demonstration projects with multiple sources, hydrogen carriers and end-use sectors to derisk future imports and increase the flexibility of supply. There are projects with Australia (coal with CCS and liquid hydrogen⁵), Saudi Arabia (oil and ammonia), Brunei (gas and liquid organic carriers) and Norway (hydropower and liquid hydrogen). Japan's strategy could have a positive global impact and contribute to the creation of new synergies regarding international energy trading and business cooperation. These will be crucial in driving development and making technologies more affordable. According to the roadmap of the Japanese Ministry of Economy, Trade and Industry (METI), Japan expects hydrogen technologies to become profitable by 2030. METI has set specific targets⁶ for green hydrogen in terms of electrolyser cost (USD 475/kW), efficiency (70%, or 4.3 kWh per normal cubic metre [Nm³]) and finally production cost (USD 3.3/kg) by 2030.

Morocco: In June 2020, Morocco signed a partnership agreement with Germany that aims to develop the production of green hydrogen and to set up related research and investment projects. The agreement represents the strong will of both countries to move forward in the development of renewable energies and their commitment to sustainable economic development, while making environmental protection a priority.

5 First item is the hydrogen production pathway and second item refers to the form of transporting hydrogen.

6 www.meti.go.jp/english/press/2019/pdf/O312_002a.pdf

Two initial projects were announced in the declaration of intent. First, the “Power-to-X” project proposed by the Moroccan Solar Energy Agency (MASEN) for the production of green hydrogen and the establishment of a research platform for this energy source. The second project covers knowledge transfer, which is one of the core activities of the “Green Hydrogen and Applications” platform from the Research Institute on Solar Energy and New Energies (IRESEN). Morocco and Germany’s plans are to develop the first industrial green gas production plant on the African continent. The industrial hydrogen plant to be built in Morocco is expected to transform the country’s renewable energy sector and thus reduce carbon dioxide emissions by 100 000 tonnes per year.

The Netherlands: The Ministry of Economic Affairs and Climate Policy presented the government strategy on hydrogen in March 2020. With this, the Dutch government has underlined its ambitions to use its unique position to develop a strong position for the country in the hydrogen market.

In this strategy document, the Dutch government elaborates on the necessity of developing a clean hydrogen economy, on the role of hydrogen in the energy transition and on its policy agenda in respect of the hydrogen market. The government notes that a completely sustainable energy supply in 2050 requires that at least 30% and up to 50% of final energy consumption be via gaseous energy carriers. Biogas and hydrogen are gaseous energy carriers which can be produced CO₂ free, but the government notes that there will not be sufficient biogas available, which makes hydrogen indispensable for meeting the expected demand for CO₂ free gas. The government states that the Netherlands is in a unique position to develop large-scale hydrogen infrastructure, specifically for the port of Rotterdam. Towards 2030, there is a desire from the industry to connect energy related clusters in order to scale-up electrolytic hydrogen production. In consultation with industrial clusters, the government will provide guidance with regard to the precise locations of electrolyzers through its Main Energy Infrastructure Programme.

Portugal: Portugal has some of the best renewable resources in the world, setting a record of USD 13.1/MWh for solar in August 2020. As such, the country’s strategy focuses only on green hydrogen. Targets for 2030 include an explicit goal for electrolyzers (2 GW-2.5 GW) and various blending and quotas that can drive demand uptake: 10%-15% blending in the gas grid; 2%-5% green hydrogen for industry; 1%-5% for transport, 3%-5% for shipping and 1.5%-2% in final energy demand. Hydrogen deployment is in line with the broader energy strategy that is part of the National Energy and Climate Plan, although this was issued just before the EU 2030 GHG reduction target was raised from 40% to 55%, which would mean a more ambitious plan is expected in its revision. Deployment is also in line with climate neutrality by 2050.

The strategy foresees investments in the order of EUR 7 billion by 2030 (mostly from private capital). There are three phases of implementation: 2020-2023 for setting up the regulatory framework and the governance system; 2024-2030 as a consolidation phase and project development; 2030-2050 for the growth of the market. Some of the shortterm measures the government will take to fulfil the strategy include: support mechanisms for the production of green hydrogen; financial resource guarantees; and a supportive regulatory framework. Already, in August 2020, hydrogen was included in the guarantees of origin system for renewable gases, as part of these measures. Portugal has also signed a memorandum of understanding with the Netherlands for large-scale trading of hydrogen. The “Green Flamingo” project covers the export from the Port of Sines in Portugal to the Port of Rotterdam in the Netherlands. The project has a size of 1GW of electrolysis and requires an investment of EUR 57 billion (including the renewable capacity).

2.

ELECTROLYSER TECHNOLOGY CHARACTERISATION

KEY POINTS

- The electrolyser is composed of the stack (where the actual splitting of water into hydrogen and oxygen takes place) and the balance of plant, which comprises power supply, water supply and purification, compression, possibly electricity and hydrogen buffers and hydrogen processing. Both components are important for the cost, since they have similar cost shares. The largest potential for near term cost reduction is in this balance of plant, while RD&D is required to reduce stack cost and increase its performance and durability, as trade offs among these are significant.
- The flexibility of alkaline and PEM stacks is enough to follow fluctuations in wind and solar. The flexibility of the system is limited, however, by the balance of plant (e.g. the compressors) rather than the stack. Furthermore, flexibility in the very short term time scales involved (*i.e.* sub-second) is not the key value proposition for electrolysers, as their key system value lies in bulk energy storage. This effectively decouples variability of generation from stability of hydrogen and power to X (PtX) demand through hydrogen storage in gas infrastructure (e.g. salt caverns, pipelines) and liquid e-fuels storage.
- There is no single electrolyser technology that performs better across all dimensions. The future technology mix will depend on innovation and competition among key technologies and manufacturers, leading to technological improvements and a better fit for different technologies and system designs in each specific application.
- Water and land use do not represent barriers to scaling up. In places with water stress, the source of water for hydrogen production should be explicitly considered in the strategies and further elaborated in project planning. Where access to sea water is available, desalination can be used with limited impact on cost and efficiency, potentially deploying multi-purpose desalination facilities to provide local benefits. A 1 GW plant could occupy about 0.17 square kilometres (km²) of land, which means 1000 GW of electrolysis would occupy an area equivalent to Manhattan (New York).
- Improving the performance of the electrolyser stack in one dimension usually goes along with reduced performance in other parameters (efficiency, cost, lifetime, mechanical strength and manufacturing). This leads to trade offs to be tackled through innovation in materials and manufacturing, leading to a set of specific system designs tailored to different applications in the future. Potential breakthroughs in technology development can be disruptive in terms of accelerating cost reductions for the stack, while for the balance of plant, it is more about economies of scale, standardisation of design and supply chains, and learning-by-doing.

Water electrolyzers are electrochemical devices used to split water molecules into hydrogen and oxygen by passage of an electrical current. They can be fragmented in three levels (see Figure 4):

- The cell is the core of the electrolyser and it is where the electrochemical process takes place. It is composed of the two electrodes (anode and cathode) immersed in a liquid electrolyte or adjacent to a solid electrolyte membrane, two porous transport layers (which facilitate the transport of reactants and removal of products), and the bipolar plates that provide mechanical support and distribute the flow.
- The stack has a broader scope, which includes multiple cells connected in series, spacers (insulating material between two opposite electrodes), seals, frames (mechanical support) and end plates (to avoid leaks and collect fluids).
- The system level (or balance of plant) goes beyond the stack to include equipment for cooling, processing the hydrogen (e.g. for purity and compression), converting the electricity input (e.g. transformer and rectifier), treating the water supply (e.g. deionization) and gas output (e.g. of oxygen).

Purified water is fed into the system using circulating pumps, or also by gravity. The water then reaches the electrodes by flowing through the bipolar plates and through the porous transport layers. At the electrode, the water is split into oxygen and hydrogen, with ions (typically H^+ or OH^-) crossing through a liquid or solid membrane electrolyte. The membrane or diaphragm between both electrodes is also responsible for keeping the produced gases (hydrogen and oxygen) separated and avoiding their mixture. This general principle has remained the same for centuries, but the technology has evolved since William Nicholson and Anthony Carlisle first developed it in 1800 (see Box 1).

Figure 4. Basic components of water electrolyzers at different levels.

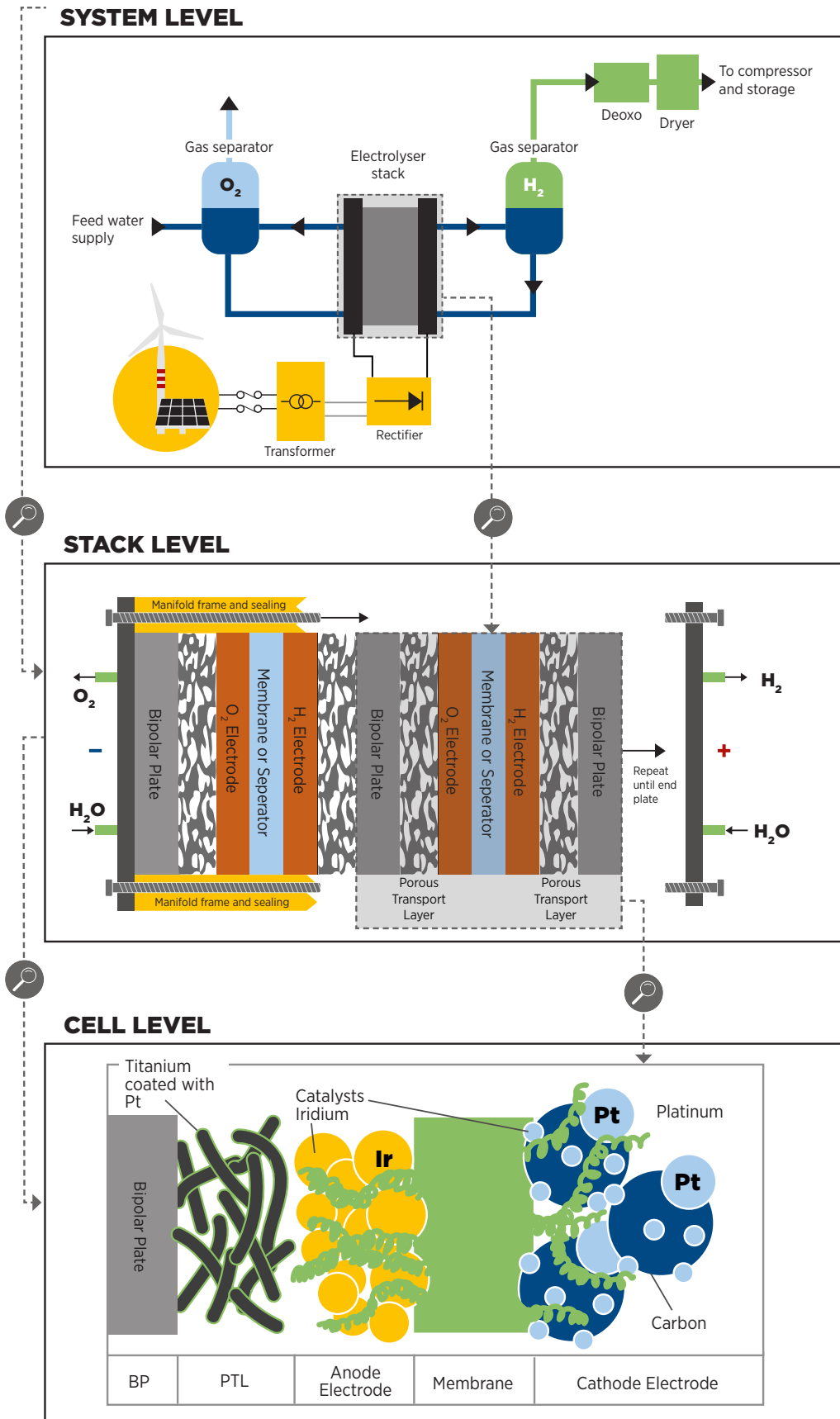

Based on IRENA analysis.

Box 1. A brief look at the historical development of electrolyzers

Electrolyzers have been known for over two centuries. While the fundamental technology has remained the same (see Figure 5), different trends have affected its development, with these splitting the period into roughly five generations.

1st generation (1800-1950): Electrolyzers were mainly used for ammonia production using hydropower (low-cost electricity). By 1900, there were more than 400 industrial electrolyzers in operation (Santos, Sequeira and Figueiredo, 2013). Electrolyzers were used in Norway, Peru, Zimbabwe and Egypt for this purpose. Alkaline electrolyser was the only technology used. They operated at atmospheric pressure, using concentrated corrosive basic solutions (e.g. potassium hydroxide [KOH]) and asbestos was used as gas separators (called diaphragms). Asbestos can pose large health hazards, but this was not known until late in the 20th century, when asbestos started to be replaced by other materials (such as ZIRFON®). While initially there were no good alternatives, composite zirconium oxide (ZrO₂) separators became the trend from mid-century. At the end of this generation, in 1948, Lonza (later IHT) was the first company to introduce pressurized alkaline electrolyser systems. Electrolyzers were also used for chlorine production, which uses the same electrochemical principle, but uses high concentrate sodium chloride in water as raw material and produces hydrogen as a by-product. This was an important application of electrolysis from the beginning of the 19th century.¹

Figure 5. Challenges and technological breakthroughs for each of the generation of electrolyzers.

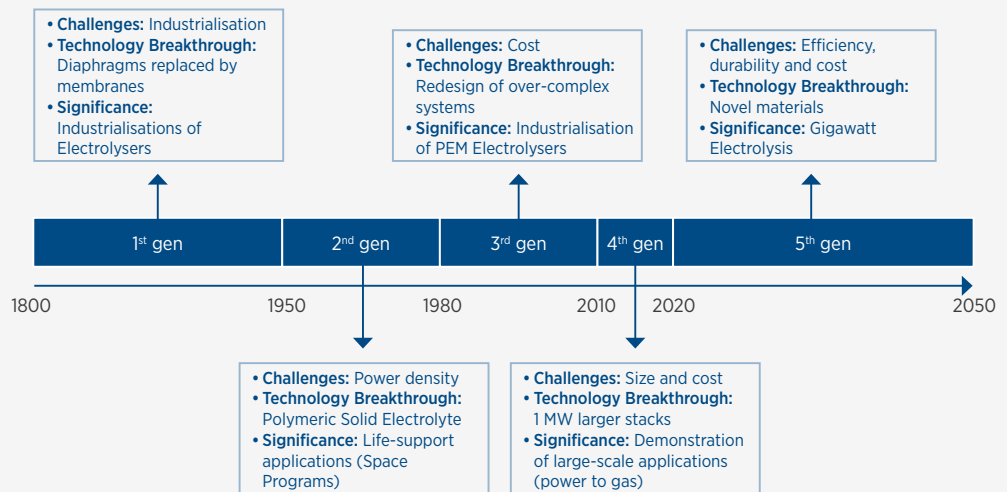

Based on IRENA analysis.

Box 1. A brief look at the historical development of electrolyzers

2nd generation (1950-1980): This generation was defined by a polymer chemistry breakthrough achieved in the last few years of the previous generation. In 1940, Dupont discovered a material that had both excellent thermal and mechanical stability, as well as ionic properties (meaning good transport properties for protons). This was the basis for PEM electrolyzers. PEM cells could be easily fed with pure water, instead of caustic solutions, as in alkaline systems, which provided a considerable reduction of system complexity, footprint, higher efficiencies and power densities. General Electric was one of the pioneers in developing PEM electrolyzers, later joined by Hamilton Sundstrand in the United States and Siemens and ABB in Germany. Deployment and learning for PEM electrolyzers were mainly driven by spaceship programs (e.g. Gemini) and military life-support applications in submarines.

3rd generation (1980-2010): With the space race over, other business opportunities had to be found for PEM electrolyzers. This required drastically simplifying the design, decreasing the cost and increasing the scale of the stacks to a few hundred kW. A higher system efficiency, lower capital costs and durability beyond 50 000 hours were the result of these changes. On the alkaline side, large units coupled to hydro-power plants had to be re designed to much smaller pressurised stacks, in order to introduce these into applications with less demand for hydrogen.

4th generation (2010-2020): Three trends characterise this generation. First, PV and wind installed capacity grew over 14 and 3 times respectively over this period, with costs dropping by 82%, 47% and 39% for PV, onshore wind and offshore wind, respectively (IRENA, 2020a). This made electricity, the main cost-component for green hydrogen, much cheaper, improving the business case for green hydrogen. Second, there has been the central role that climate change has taken in the political agenda. This has created support for decarbonising sectors other than power. Third, is the ever increasing capacity of advanced electrolyser stacks, leading to lower capital expenditure (CAPEX) for electrolyzers, allowing green hydrogen to move up the energy policy agenda.

5th generation (post-2020): This period is expected to take electrolysis from niche to mainstream, from MW to GW scale, from potential to reality. The goals for this period include a lower (< USD 200/kW) cost, high durability (> 50 000 hours) and a high (approaching 80% LHV) efficiency. This will require economies of scale, a larger manufacturing capacity and technological breakthroughs through research.

2.1 ELECTROLYSER TECHNOLOGIES

The principle of water electrolysis is simple, yet it allows the construction of different technological variations based on various physical-chemical and electrochemical aspects. Electrolysers are typically divided into four main technologies. These are distinguished based on the electrolyte and temperature of operation, which in turn will guide the selection of different materials and components.

The principles of all commercially available types of electrolysis cells are displayed in Figure 6. Many variations within each technology exist, with most radical differences being related to cell design, variation within components, and degree of technology maturity.

Solid oxide and anion exchange membrane (AEM) have high potential, but are much less mature technologies, with only a few companies and original equipment manufacturers (OEMs) involved in their manufacture and commercialisation. These are mostly based in Europe.

There are four types of electrolyser: Alkaline and polymer electrolyte membrane (PEM) are already commercial, while anion exchange membrane (AEM) and solid oxide, now at lab scale, promise a major step forward

Figure 6. Different types of commercially available electrolysis technologies.

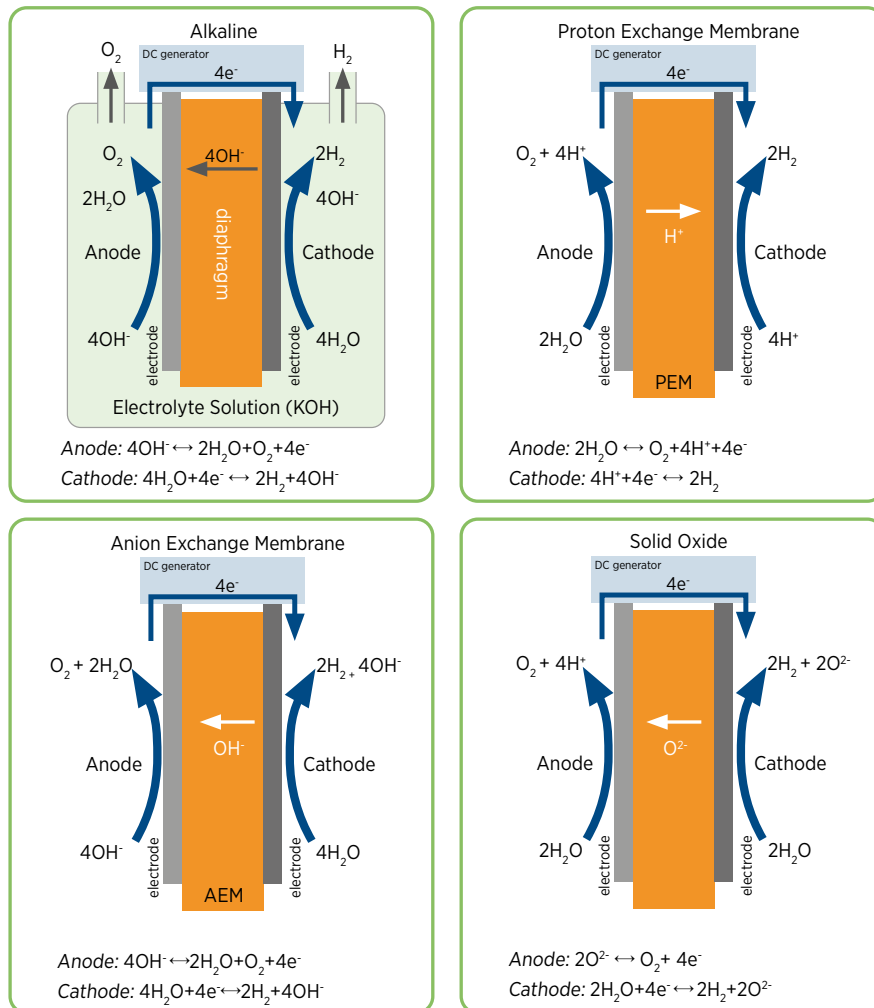

Based on IRENA analysis.

Hence, the basic principle of a water electrolysis cell consists of two electrodes separated by an electrolyte. The electrolyte is the media responsible for transporting the generated chemical charges (anions (-) or cations (+)) from one electrode to the other. In the alkaline type, the electrolyte responsible for transporting the OH⁻ anions is typically a highly concentrated potassium hydroxide solution. The electrodes and produced gases are physically separated by a porous inorganic diaphragm (also called a separator) that is permeable to the KOH solution. In PEM, AEM, and solid oxide electrolyzers, the electrodes are separated by an electron-insulating solid electrolyte, which is responsible for transporting

ions from one electrode to the other and at the same time physically separating the produced gases. For these, there is no need to add a liquid electrolyte solution, and the ion transport happens within the PEM, AEM or solid oxide component.

Table 1 summarizes the operating conditions and the most important components for the four types of electrolyzers. The coloured cells represent conditions or components with significant variation from different manufacturers or R&D institutions. In this respect, it also gives a sense of the less mature technologies, which is clear for the AEM and solid oxide types.

Table 1. Characterisation of the four types of water electrolyzers.

	Alkaline	PEM	AEM	Solid Oxide
Operating temperature	70-90 °C	50-80 °C	40-60 °C	700-850 °C
Operating pressure	1-30 bar	< 70 bar	< 35 bar	1 bar
Electrolyte	Potassium hydroxide (KOH) 5-7 molL ⁻¹	PFSA membranes	DVB polymer support with KOH or NaHCO ₃ 1molL ⁻¹	Yttria-stabilized Zirconia (YSZ)
Separator	ZrO ₂ stabilized with PPS mesh	Solid electrolyte (above)	Solid electrolyte (above)	Solid electrolyte (above)
Electrode / catalyst (oxygen side)	Nickel coated perforated stainless steel	Iridium oxide	High surface area Nickel or NiFeCo alloys	Perovskite-type (e.g. LSCF, LSM)
Electrode / catalyst (hydrogen side)	Nickel coated perforated stainless steel	Platinum nanoparticles on carbon black	High surface area nickel	Ni/YSZ
Porous transport layer anode	Nickel mesh (not always present)	Platinum coated sintered porous titanium	Nickel foam	Coarse Nickel-mesh or foam
Porous transport layer cathode	Nickel mesh	Sintered porous titanium or carbon cloth	Nickel foam or carbon Cloth	None
Bipolar plate anode	Nickel-coated stainless steel	Platinum-coated titanium	Nickel-coated stainless steel	None
Bipolar plate cathode	Nickel-coated stainless steel	Gold-coated titanium	Nickel-coated Stainless steel	Cobalt-coated stainless steel
Frames and sealing	PSU, PTFE, EPDM	PTFE, PSU, ETFE	PTFE, Silicon	Ceramic glass

Note: Coloured cells represent conditions or components with significant variation among different companies. PFSA = Perfluoroacidsulfonic; PTFE = Polytetrafluoroethylene; ETFE = Ethylene Tetrafluoroethylene; PSF = poly (bisphenol-A sulfone); PSU = Polysulfone; YSZ = yttrastabilized zirconia; DVB = divinylbenzene; PPS = Polyphenylene sulphide; LSCF = La_{0.58}Sr_{0.4}Co_{0.2}Fe_{0.8}O_{3-δ}; LSM = (La_{1-x}Sr_x)_{1-y}MnO₃; § = Crofer22APU with co-containing protective coating.

Based on IRENA analysis.

2.2 CELL LEVEL FOR EACH TYPE OF ELECTROLYSER

Alkaline electrolyzers: These have a simple stack and system design and are relatively easy to manufacture. Currently, they have electrode areas as high as 3 square metres (m²). They operate with high concentrate KOH (typically 57 moles of solute per litre of solution [mol*L⁻¹]) as electrolyte, robust ZrO₂ based diaphragms and nickel (Ni) coated stainless-steel for the electrodes. The ionic charge carrier is the hydroxyl ion OH⁻, with KOH and water permeating through the porous structure of the diaphragm to provide functionality for the electrochemical reaction. This allows the intermixing of the produced gases (hydrogen and oxygen – H₂ and O₂) that are dissolved in the electrolyte, limiting lower power-operating range and the ability to operate at higher pressure levels.

To prevent this, thicker (0.252 millimetre [mm]) diaphragms are used, but this creates a higher resistance and lower efficiencies. Spacers are sometimes included by some manufacturers between electrodes and diaphragms to further avoid the intermixing of gases. These thick diaphragms and added spacers result into high ohmic resistances across the two electrodes, drastically reducing current density at a given voltage. Today's advanced designs, using zero-gap electrodes, thinner diaphragms and different electrocatalyst concepts to increase current density, have already reduced their performance gap in comparison to PEM technology. On the other hand, classic and sturdy alkaline designs are known to behave very reliably, reaching lifetimes above 30 years.

Polymer Electrolyte Membrane (PEM) electrolyzers: These use a thin (0.2 mm) PFSA membrane and electrodes with advanced architecture that allows achieving higher efficiencies (*i.e.* less resistance). The perfluorosulfonic acid (PFSA) membrane is also chemically and mechanically robust, which allows for high pressure differentials. Thus, the PEM cells can operate at up to 70 bar with the oxygen side at atmospheric pressure.

The acidic environment provided by the PFSA membrane, high voltages, and oxygen evolution in the anode creates a harsh oxidative environment, demanding the use of materials that can withstand

these conditions. Titanium-based materials, noble metal catalysts and protective coatings are necessary, not only to provide long-term stability to cell components, but also to provide optimal electron conductivity and cell efficiency. These requirements have caused PEM stacks to be more expensive than alkaline electrolyzers. PEMs have one of the most compact and simplest system designs, yet they are sensitive to water impurities such as iron, copper, chromium and sodium and can suffer from calcination. Today, electrode areas are quickly approaching 2 000 square centimetres (cm²), yet this is still far from future concepts of large MW stack units using single stack concepts. Last but not least, the reliability and lifetime characteristics of large-scale, MW PEM stacks still have to be validated.

Each technology has its own challenges, from critical materials to performance, durability and maturity; there is no clear winner across all applications, which leaves the door open for competition and innovation driving costs down

Solid oxide electrolyzers (SOEC): These operate at high (700-850°C) temperatures. This enables: the favourable kinetics that allow the use of relatively cheap nickel electrodes; electricity demand decreases and part of the energy for separation is provided through heat (waste heat can be used and apparent efficiencies based on electricity can be higher than 100%); the potential for reversibility (operating as fuel cell and electrolyser)⁸; co-electrolysis of CO₂ and water to produce syngas (which is the basic building block for the chemical industry). On the downside, thermo-chemical cycling, especially under shutdown/ramping periods, leads to faster degradation and shorter lifetimes. Other issues related to stack degradation include: challenges related to sealing at higher differential pressure; electrode contamination by silica used as sealants; and other additional contaminant sources from piping, interconnects and sealing. SOECs are today only deployed at the kW-scale, although some current demonstration projects have already reached 1 MW.

8 Reversible PEM or Alkaline technologies exist, but are much less efficient and more complex, and have not being commercially demonstrated yet. Reversible operation also compromises durability

Anion Exchange Membranes (AEM): This is the latest technology with only a few companies commercialising it, with limited deployment. AEM’s potential lies in the combination of a less harsh environment from alkaline electrolyser with the simplicity and efficiency of a PEM electrolyser. It allows the use of non-noble catalysts, titanium-free components, and, as with PEM, operation under differential pressure. The reality, however, is that the AEM membrane has chemical and mechanical stability problems, leading to unstable lifetime profiles. Moreover, performance is not yet as good

as expected, mostly due to low AEM conductivity, poor electrode architectures and slow catalyst kinetics. Performance enhancement is typically achieved by tuning membrane conductivity properties, or by adding a supporting electrolyte (e.g. KOH, or sodium bicarbonate [NaHCO₃]). Such tuning could lead to decreased durability, however. The OH⁻ ion is intrinsically three-fold slower (lower conductivity) than H⁺ protons within PEM, which forces AEM developers to either make thinner membranes, or ones with higher charge density.

2.3 SYSTEM LEVEL FOR EACH TYPE OF ELECTROLYSER

System Components

Alkaline systems: As for the other types, alkaline electrolyser require recirculating the electrolyte (KOH) into and out the stack components. This creates a pressure drop that requires specific pumping characteristics and negatively affects the efficiency, which is typically less than 0.1% of the stack power consumption, but can be much higher for other manufacturers. Some alkaline systems are also operated without pumping peripherals. After leaving the stack, this alkaline solution needs to be

separated from the gases produced. This is done in gas-water separators that are placed above the stack at a given height, and KOH/water flows back to the stack. The water phase can be removed at the bottom and the gas phase at the top (see Figure 7). The water column within the separator also serves as a buffer storage for changing load specifications.

The water management system regulates the filling level of each gas separator, and water permeation via the diaphragm needs to be considered.

Figure 7. Typical system design and balance of plant for an alkaline electrolyser.

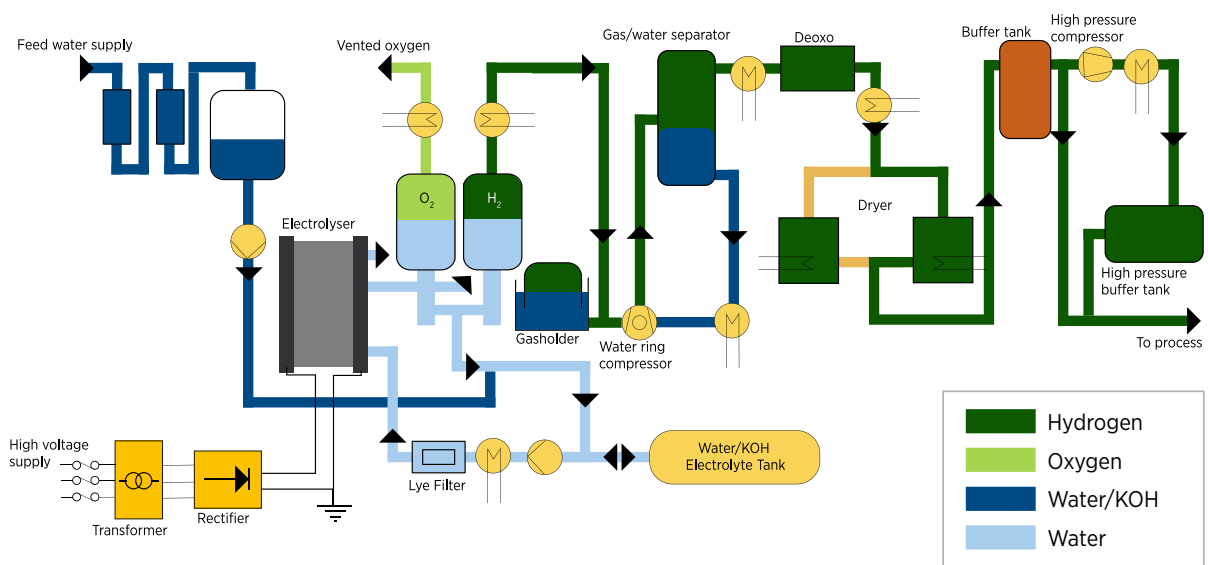

Note: This configuration is for a generic system and might not be representative of all existing manufacturers.

Based on IRENA analysis.

Water can be transported to the anode side by the solvated species and charges. A mixing pipe is also installed between the anode and cathode water/gas separator to balance the OH⁻ charges consumed/produced along with the electrochemical reaction.

Equipment around the electrolyser is affected by technology choice. There needs to be an integrated design for various components to achieve a low cost while satisfying demand requirements

The requirement to balance the charges between anode and cathode makes the stack more challenging to operate at differential pressures, as in PEM. Nevertheless, pressurised operation is possible and available in designs with pressures as high as 200 bar. But such operations are made by keeping both sides of the stack (hydrogen and oxygen) at high pressure and contained in a high-pressure vessel. For the high-pressure configuration, more resistance cell frames and balance of plant (BoP) materials are needed, which impact on CAPEX.

PEM systems are much simpler than alkaline. They typically require the use of circulation pumps, heat exchangers, pressure control and monitoring only at the anode (oxygen) side. At the cathode side, a gas-separator, a de-oxygenation component to remove remnant oxygen (typically not needed for differential pressure), gas dryer, and a final compressor step are required (see Figure 8).

More importantly, PEM systems have more design choices: atmospheric, differential, and balanced pressure (design is fixed to a single one); reducing costs, system complexity, and maintenance. Under a balanced pressure operation, the anode and cathode are designed to run under the same pressure level. Atmospheric pressure operation (< 1 standard atmosphere [atm]) represents a case of constant pressure operation mode. The PEM membrane electrolyte allows for operation under differential pressure, typically 30 bar to 70 bar. This, however, requires a thicker membrane to improve the mechanical stability and decreases gas permeation, which reduces efficiency. It could also require an additional catalyst to re-convert any hydrogen, which, due to higher pressures, would now permeate more, back to water.

Figure 8. Typical system design and balance of plant for a PEM electrolyser.

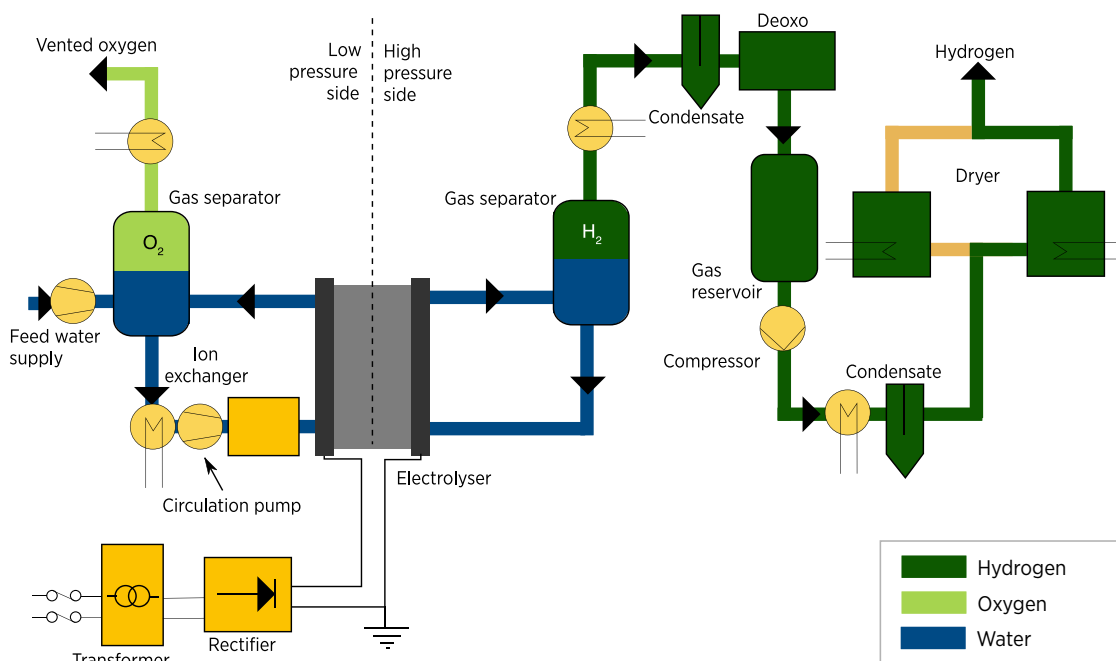

Note: This configuration is for a generic system and might not be representative of all existing manufacturers.

Based on IRENA analysis.

AEM electrolyzers have similar system design concepts to that of PEM electrolyzers (see Figure 9). Due to the low maturity of this technology, however, there is limited information on the challenges related to high differential pressure operation. At this early stage, improvements are expected in the mechanical stability of AEM

membranes, gas purity, their ability to withstand high pressure differentials and their greater power range compared to alkaline. AEM electrolyzers are still limited to a much narrower range of power input in comparison to PEM electrolyzers. The limitation, therefore, is not in the stack itself, but in the sizing of the balance of plant.

Figure 9. Typical system design and balance of plant for an AEM electrolyser.

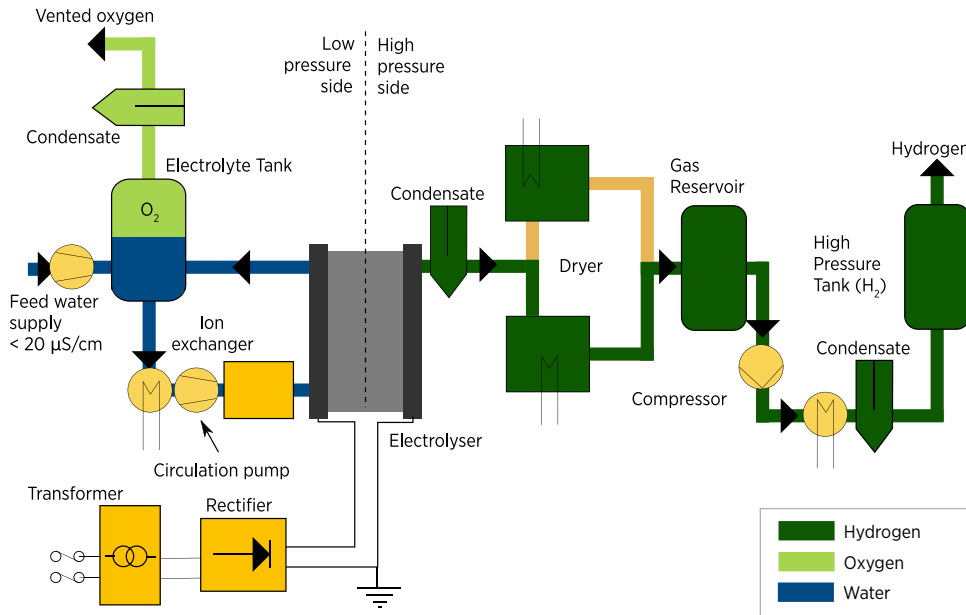

Note: This configuration is for a generic system and might not be representative of all existing manufacturers. Based on IRENA analysis.

Figure 10. Typical system design and balance of plant for a solid oxide electrolyser.

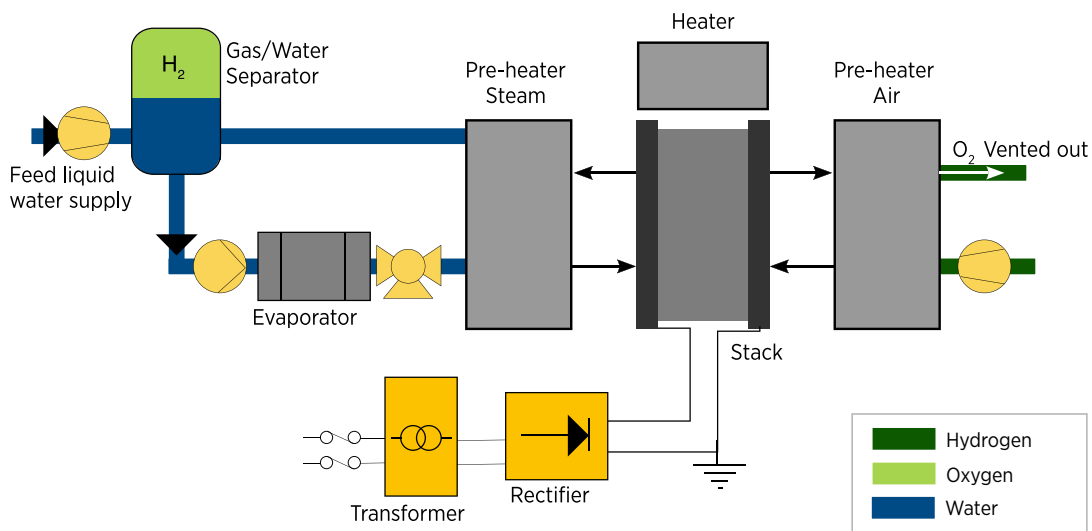

Note: This configuration is for a generic system and might not be representative of all existing manufacturers. Based on IRENA analysis.

Solid oxide electrolyzers can be coupled with heat-producing technologies for a higher system efficiency, as the electrolysis of water is increasingly endothermic with increasing temperature. Therefore, energy demand is rapidly reduced, due to the Joule heating of the cell, and then utilised in the water splitting reaction at high temperatures. When the cell runs endothermically, heat for water vaporisation can be supplied from other sources, such as waste-heat from industry or concentrated solar power plants. One important and fully renewable option is coupling SOECs with concentrated solar power, which could supply both electricity and the heat to the SOEC electrolyser. A typical system configuration for solid oxide is shown in Figure 10.

Hydrogen processing unit: Compression

Hydrogen from the electrolyser is in gaseous form, conventionally from atmospheric pressure to 30 bar, while higher pressures are possible. To facilitate hydrogen transport, a lower volume is needed. This means either increasing the pressure, liquefying the gas⁹, or converting it for liquid organic hydrogen carriers. Compression can make a large

difference. Going from atmospheric to 70 bar (a typical pressure for transmission pipelines) can already reduce the gas volume by a factor of 65. Compressing it to 1000 bar (a typical pressure for storage in tanks) can reduce the volume by a factor of 625 compared to atmospheric, and liquefaction by a factor of 870 (BNEF, 2019).

Compression can be done in mainly three ways: using a standard separate compressor; by changing the operating pressure of the electrolyser; using a separate electrochemical device. From the perspective of equipment count and process complexity, doing both the compression and the hydrogen production in the electrolyser might be an attractive option. The downsides, however, are the design of the electrolyser to be able to withstand a higher pressure (cost) and the potential increase in gas permeation through the membrane (efficiency and durability). With higher pressures in the electrolyser, the permeation losses increase, which means more hydrogen ends up on the oxygen side rather than on the product side, which in turn translates into a higher energy consumption for the same production rate and a higher safety risk for the anode (see Figure 11).

Figure 11. Energy losses for compression in a pressurized electrolyser as a function of delivery pressure and thickness of membrane.

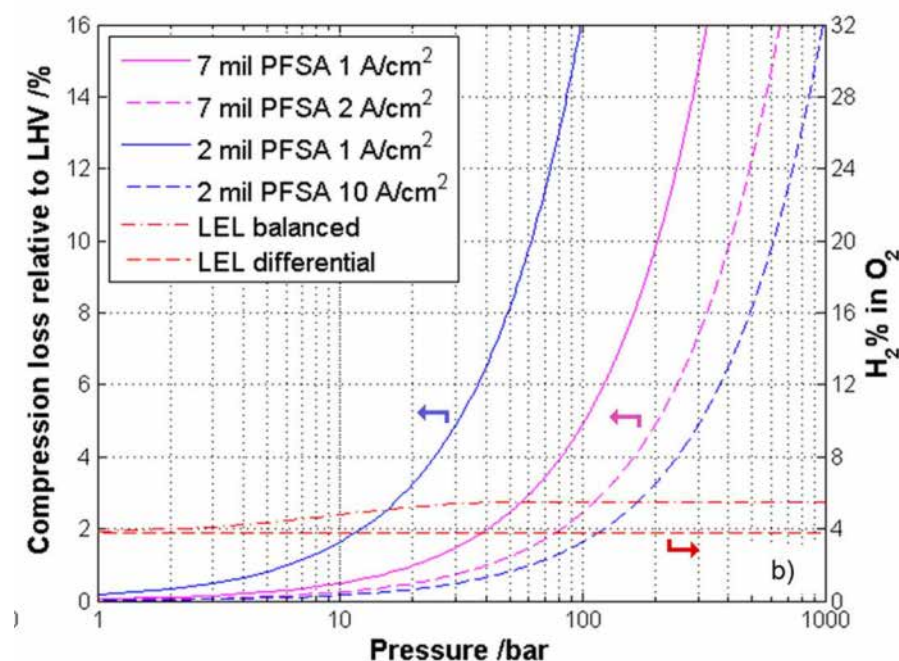

Source: Babic et al, 2017.

9 Another option is to convert it to ammonia, methane, liquid, but this section focuses on pure hydrogen.

For PEM electrolyzers, there are two modes of pressurized operation: balanced and differential. In the balanced mode, there is a similar pressure on the anode and cathode sides. This means the membrane, spacers and porous transport layer can all be thinner given the lower requirement for mechanical strength. This in turn translates into a higher efficiency, since there is less internal cell

resistance. The downside of the pressurised mode is that the entire equipment needs to be designed for a higher pressure, resulting in a penalty cost and safety issues due to the pressurised oxygen. In the differential mode, only the anode is subject to the higher pressure, as it receives all the pressure from the cathode side, where the production of pressurised hydrogen occurs.

Figure 12. Energy losses for the multi-stage mechanical compression of hydrogen.

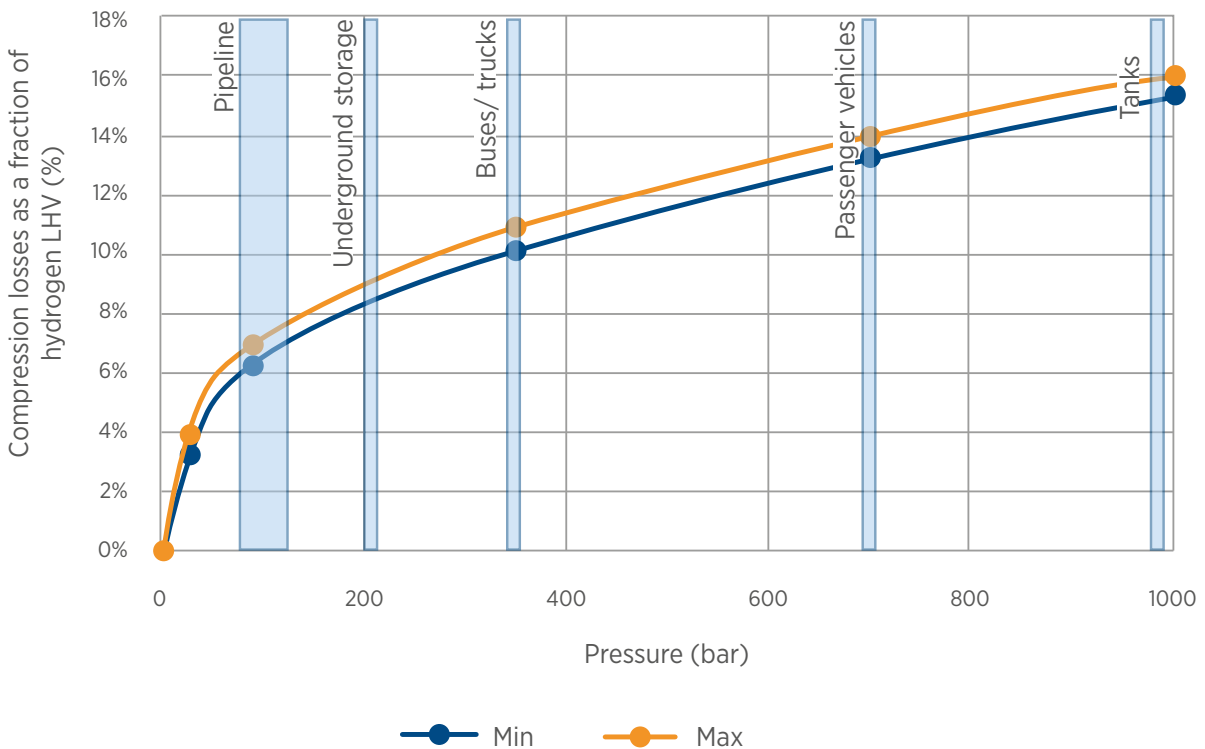

Based on IRENA analysis based on BNEF, 2019.

From an efficiency perspective, compressing to 30 bar in the electrolyser (or even 100 bar, depending on the specific membrane) has a relatively small penalty on efficiencies and additional costs for pressure vessels, while this region is the one with the steepest losses in mechanical compression¹⁰ (see Figure 12). Therefore, it makes sense to perform this step with the electrolyser to generate the largest savings for the system and compress to the final delivery pressure in a separate compressor. This means PEM, or pressurised alkaline, is preferred from this perspective. Otherwise, the additional energy penalty for compressing from 1 to 30 bar

(typical operating pressures for the alkaline and PEM electrolyzers respectively) is about 3.5%-4% equivalent of hydrogen lower heating value (this energy is used as electricity instead of directly from the hydrogen compressed).

Yet, efficiency is only one dimension. From a cost perspective, for a 100-MW electrolyser, a compressor of about 4 MW would be needed to take the stream from a typical atmospheric alkaline electrolyser to the typical operating pressure of a pressurised electrolyser (30 bar). This size already benefits from economies of scale and only adds about

¹⁰ A critical parameter for compression is the pressure ratio. Going from 1 bar to 60 bar is a ratio of 60 and therefore, it requires more energy than going from 60 bar to 300 bar.

USD 0.07/kg H₂. For higher pressures, the cost penalty would be the same for both technologies. This price differential translates to about USD 50/kW¹¹, which represents the cost differential threshold for atmospheric alkaline stacks to be on a par with 30 bar (PEM) stacks. According to Saba (Saba et al., 2018), the cost increase for changing the design pressure from 1 bar to 15 bar is about USD 150/kW for an alkaline electrolyser. Another factor affecting cost is the type of design for the PEM electrolyser. Differential pressure mode is preferable, as it eliminates balance-of-plant high-pressure components on the oxygen side. Stack costs are at the same time increased, however, since stack components on the oxygen side need to sustain the set operating pressure. A tradeoff sits between 30 bar and 70 bar, depending on each business case and application. Compression also has a cost associated with the disposal of the compressor condensate, which can be as high as USD 1 000 per day for a 20 MW system.

Compression costs are relatively small compared to overall production costs, even when considering operation at atmospheric pressure, with further benefits of a simpler design with cheaper materials for the lower pressures

There are two other factors to consider. The first one is scale. Large compressors are more efficient than small ones and will result in a smaller cost addition to the hydrogen produced. Hence, as the scale increases, it tends to favour mechanical compression over electrochemical. The second factor is final delivery pressure. In case a pressure higher than the operating pressure of the electrolyser is needed, mechanical compression will be needed, in any case. In this instance, making the compressor larger and being able to achieve a cost reduction in the electrolyser, might be attractive.

Power supply system

Power supply for electrolysers represents a significant cost component (20%-30% of the total), yet there is a high potential for cost reductions (see Chapter 2, Section 6). For small-scale electrolysis plants, power supply is often either part of the package sold by electrolyser manufacturers, or a custom design from engineering, procurement and construction (EPC) contractors for each individual facility. As the scale of the facility increases, standard utility scale power supply systems become available from leading manufacturers of electrical equipment. This can significantly reduce cost and increase the performance of the power supply for electrolysers. Further optimisation can be achieved by careful system integration of different components in the electrolyser facility, optimising the entire facility rather than individual components and leveraging efficiency gains in different parts of the balance of plant, including the power supply.

The water electrolysis industry is benefiting significantly from the improvements made in the solar industry, and the power supply also has an important role to play in maximising the efficiency of the electrolysis facility. While the electrolyser stack has a linear efficiency decrease with the increase in output, due to the increase in voltage, rectifiers have very low efficiency at low load (Kim et al., 2013). Depending on the expected operating regime (e.g. fixed output, variable input driven directly by solar or wind), the sizing and design of the power supply can be optimised to maximise system efficiency, defined as the minimisation of efficiency losses from power input to hydrogen output at the required pressure. Optimised design affects not only the efficiency, but also the flexibility of the system, as discussed in Chapter 3, Section 5.

Power supply system cost can decline through economies of scale, standardised designs and participation of specialised electrical equipment suppliers instead of electrolyser manufacturers

11 Assuming a 50% capacity factor for a hybrid PV-wind plant.

Water and land use for green hydrogen production

Green hydrogen production uses water as a key feedstock and renewable electricity as an energy source to separate hydrogen and oxygen from water in an electrolyser.

Water, as pure as possible, is therefore a key input. While the purity level required varies depending on the technology, the cost of water purification is marginal, starting from desalinated sea water (well below USD 1/cubic metre (m³) of water (Reddy and Ghaffour, 2007)). Impurities in the water, however, will have a major impact on the lifetime of the electrolyser stack (see Chapter 2, Section 4), which can in turn affect hydrogen cost by increasing the annuity of the electrolyser in the cost of hydrogen. In addition to desalination costs, the need for any water treatment in the electrolyser stack requires additional costs (e.g. deioniser). These can potentially become significant, depending on the purity level required, but are still of low impact on the overall cost of hydrogen, as in general they remain around USD 1/m³ (Hand, Guest and Cusick, 2019), or less than USD 0.01/kg H₂.

Water use is not barrier to scaling up electrolysis. Even in places with water stress, sea water desalination can be used with limited penalties on cost or efficiency

From a pure, stoichiometric perspective, 1 kg of hydrogen requires 9 kg of water as input. Due to some inefficiencies in the process, however, taking into account the process of water demineralisation, with typical water consumption, the ratio can range between 18 kg and 24 kg of water per kilo of hydrogen. The largest water consumption is actually upstream and it is the highest when the electrolyser is coupled with PV. Water consumption for green hydrogen from PV can vary between 22 and 126 kg of water per kg of hydrogen depending on the solar radiation, lifetime and silicon content (Shi, 2020). The water scarcity is highly specific to a region since it compares the water use to the replenishment of water in the

area, so local impact assessments are needed when there is hydrogen production in water-stressed regions. One of the methods to assess the impact from water use at the midpoint level is the Available Water REMaining (AWARE) method developed by a working group of the UNEP-SETAC Life Cycle Initiative (Mehmeti, 2018).

In terms of the impact of hydrogen production on water availability, this is clearly not an issue, as long as the assumption is that desalinated sea water is used. If freshwater is the preferred water source, a comparison can be made with current freshwater consumption for thermal power plants. Considering a very large 1 GW electrolyser, operating with an efficiency of 75% for 8 000 hours per year, the annual hydrogen production would be 0.15 million tonnes of hydrogen and 3 million tonnes of water (assuming 20 kg of water use per kilo of hydrogen). This corresponds to the consumption of water of a small city (around 70 000 inhabitants) with a consumption of 45 m³ per inhabitant. The acceptability of this will depend on the water availability at the location of the plant, with desalination remaining a key option to be part of the design of the plant, especially in water-stressed regions. The water source for large scale hydrogen production should be explicitly accounted for in hydrogen strategies, as the volumes might be significant for water-stressed regions. Desalination can, however, be deployed jointly for hydrogen production as well as other uses (e.g. human consumption and agriculture), with hydrogen production helping to increase water supply by driving the deployment of multi-purpose desalination facilities in water-stressed regions.

For the expected 19 exajoules (EJ) of green hydrogen (approximately 160 megatonnes [Mt]) in the Transforming Energy Scenario of the IRENA Global Renewables Outlook, we would require around 3 billion m³ of water per year in 2050. This is 0.08% of the current global consumption of freshwater. As freshwater is used for a multiplicity of non-energy uses (e.g. agriculture), a better comparison is the current consumption of thermoelectric power plants, which is significantly higher: for instance, the estimated water consumption by thermal power plants in the United States in the 2030 reference case was 5.8 billion m³ (IRENA, 2015). Even for more ambitious scenarios, where decarbonisation is

faster and hydrogen plays a larger role, the overall water demand would be relatively small compared to global water consumption. Additionally, any green hydrogen produced that is used in fuel cells for transportation purposes, or eventually re-electrification, will produce ultra-pure water that could be recovered where economically feasible, in particular, in stationary applications.

For the land area, there are no real projects of more than 100 MW in water electrolysis¹²(the largest one, as of November 2020, is 20 MW, in Becancour, Canada). Thus, so far, land area estimates rely on engineering estimates, rather than plot optimisation based on real experience. Yet, there are a couple of estimates available:

- A study funded by the German government in 2014 estimated that a 100 MW electrolyser plant would occupy about 6 300 m² (DLR, 2014).
- Siemens estimated back in 2017 that a 300 MW electrolyser plant would occupy about 180 metres (m) x 80 m (15 000 m²) (Bolhuis, 2017).
- ITM estimated in 2017 that one 100 MW electrolyser would occupy about 40 m x 87 m (3 500 m²), with the possibility of using multiple layout options to fit different applications and of replicating this easily by having a standardised design (Bourne, 2017).
- In 2018, McPhy proposed a 100 MW facility (composed of five modules of 20 MW each) with a plot size of 4 500 m² (McPhy, 2018).

More recently, given the various multi-GW national strategies, there are studies looking at what it could mean to have these multi-GW facilities. One study comes from the Institute for Sustainable Process Technology (ISPT) in the Netherlands, which made a detailed bottom-up study for a 1 GW alkaline and PEM plant (ISPT, 2020). As a result, the maximum area requirements were 13 ha and 17 ha (0.13 km²-0.17 km²) for a PEM and an alkaline electrolyser plant respectively, with the potential to decrease the land requirements with compact designs of 8 ha and 10 ha respectively (see Figure 13 left for the plot size of an alkaline electrolyser). The bulk of this space (65%-75%) is for the electrolyser building and the electrical equipment (e.g. switchgears and transformers), with the least space used by the hydrogen processing section.

To put these numbers in perspective, a global capacity of 1 000 GW of electrolysers, which would be enough to replace the entire current pure and mixed hydrogen fossil-based production, would occupy a land area of the size of Manhattan, New York, using the most conservative estimate (i.e. 0.17 km²). Another reference is that this energy density of almost 7 500 MW/km² is almost 1500 times larger than a relatively good onshore wind density of 5 MW/km² (Enevoldsen et al., 2019), which means the electrolyser would only be a fraction of the space occupied by the renewable electricity input, highlighting the need to use hydrogen only for applications that are hard to electrify and reduce the upstream renewable capacity needed to satisfy the same demand.

Figure 13. Plot size for an alkaline 1-GW electrolyser plant (left) and for a 100-MW alkaline electrolyser from Thyssenkrupp (right).

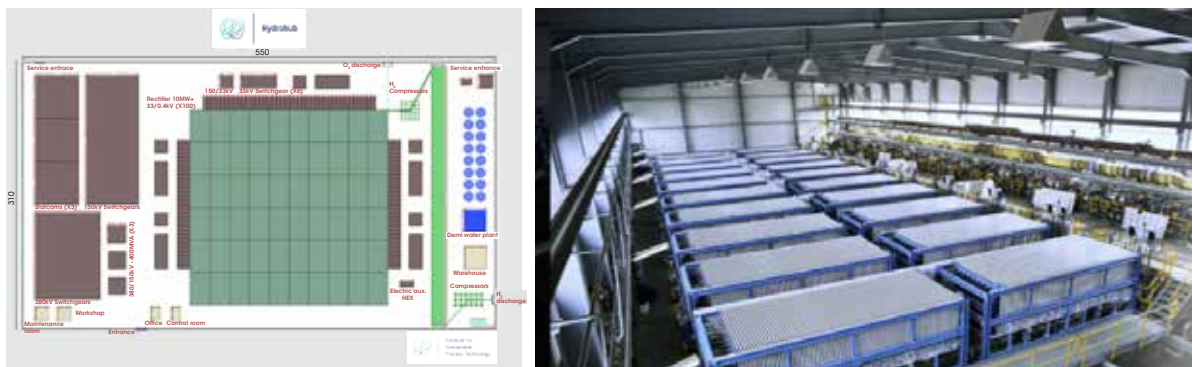

Based on IRENA analysis based on ISPT, 2020.

12 There are electrolyser plants of this size (and larger) for chlorine production (see Figure 13).

2.4 TRADE-OFFS TO CONSIDER IN THE DESIGN OF THE ELECTROLYSER

On the supply side, the prospects for green hydrogen depend on the performance of the electrolyser. The key dimensions that R&D strategies need to address are:

- The efficiency increase at the cell, stack, and system level (this reduces operational cost).
- The current to the stack is directly related to cell and stack capacity and therefore to hydrogen production.
- A durability increase to more than 100 000 hours for any developed system concept.
- An investment cost reduction (both stack and system).

These four dimensions are related to each other, however, and improvement in one of them usually leads to a poorer performance in another. For example, a thicker membrane is mechanically stronger and leads to longer lifetime profiles, but

it also increases the resistance to the transport of charges, which in turn decreases the efficiency. While the longer lifetime results in a lower cost contribution of the investment component, the lower efficiency results in a higher operating cost given the higher electricity consumption. Figure 14 shows the positive or negative effect (arrows + colour) some of the independent choices during manufacturing and research (green boxes) can have on each dimension. Another two important aspects are the use of more active catalysts that are able to improve efficiency levels, but could have negative impact on durability. One example is ruthenium catalysts, which are more active than iridium, but suffer from long-term stability. Moreover, any catalyst free of critical raw materials needs to be aimed at higher efficiencies, but this typically result in catalysts that are less robust and more prone to dissolution.

Figure 14. Trade-offs between efficiency, durability and cost for electrolysers.

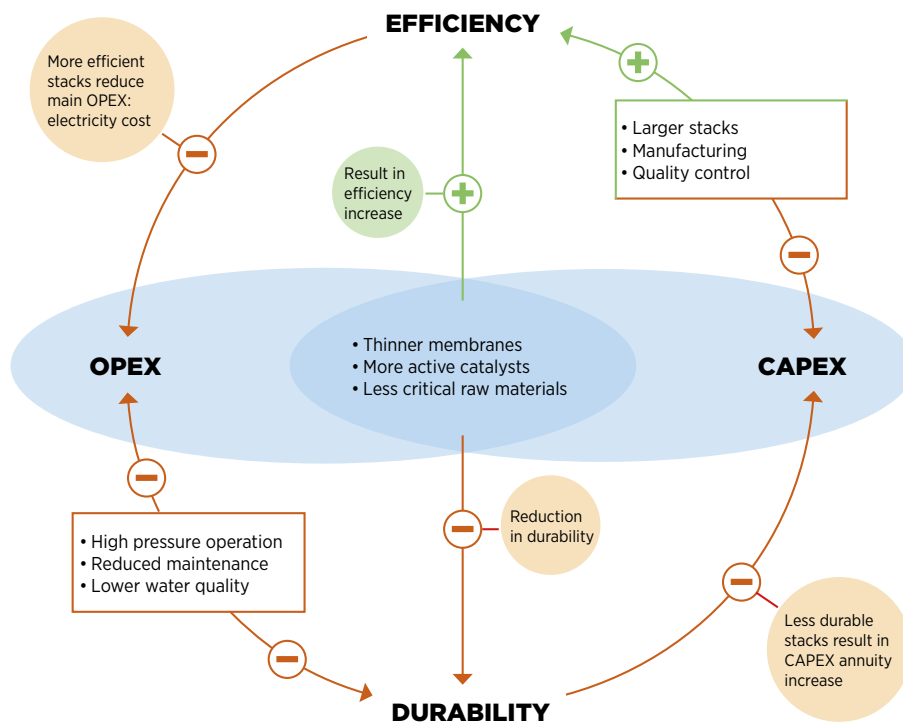

Note: The arrows represent a direct impact or effect from the R&D of a given material or component over each relevant dimension. CAPEX = capital expenditure; OPEX = operational expenditure.

The specific business case for the electrolyser will also affect the optimisation of these parameters. For example, an electrolyser that is coupled with PV could only operate typically less than 2000 hours in a year, making the capital cost a critical parameter to tackle. With such limited operating hours, durability might be less of an issue, since a short operating lifetime still translates into a longer actual lifetime. This could lead to using materials that are cheaper, but degrade faster. This case is different to one where the electrolyser is coupled with a concentrated solar power that has higher operating hours in a year, but that delivers a higher electricity price, making efficiency more important to reduce the operational cost.

Improving the performance of the electrolyser in one dimension usually goes along with reduced performance in other parameters. This leads to trade-offs during the innovation process instead of having a single best-performing design

Broadening the scope and looking beyond cost also influences the tradeoffs between these parameters. Considering the revenue side could lead to changing the operating strategy of the electrolyser. For instance, bidding in the balancing market to complement the revenues from hydrogen sales. This could have a negative effect on durability, since it could result in faster membrane degradation, requiring a more frequent replacement of membranes and consequently all other related components, but could also slightly reduce the contribution of the capital cost given increased operating hours (*i.e.* times when the electrolyser would not be operating based on hydrogen sales only, but doing so based on the additional revenues from balancing). Similarly, increasing the current operating density can create higher production flow at the expense of faster degradation.

Lifetime aspects related to materials and components

The lifetime of electrolyser technologies is a function of the cumulative current passing through the stack, which can be represented by the number of full load hours¹³ as well as the number of operating hours – the number of hours during which the facility is on, regardless of load operating levels.

Alkaline electrolysers are the most robust, with proven lifetimes of over 30 years. Some of the factors that affect their lifetime are:

- **Gas permeation:** The diaphragm is exposed to a continuous flow of KOH, gas permeation, and local hot spots created by the deposition of impurities on electrode coatings. This eventually causes small, pin-hole failures that increase in size over time and lead to gas contamination. Since the stacks usually have large areas, reaching up to 3 m in diameter and hundreds of cells, inspecting is not a feasible option. Instead, the oxygen stream is monitored and when the hydrogen concentration reaches 2% on the oxygen side, the stacks are sent for repair or disposal. One solution is to use polyphenylene sulphide fabric diaphragms. This negatively impacts the hydrogen production efficiency, but has a positive effect on lifetime, since it limits gas permeation. These negative aspects have been constantly changed for new generation diaphragms and under low pressure operation, and a few companies have claimed to have already solved these issues.
- **Electrodes:** Deactivation of electrodes on the cathode and anode sides have been prevented in some systems by using small idle protective currents within a few microamperes of current to avoid reversal of potentials of cathodes, potentially leading to less active electrodes overtime.

¹³ Full Load hours are the number of hours the electrolyser would have taken to consume the amount of energy current consumed over a period of time (typically one year), had it been operating at full capacity, in relation to the electrolyser plate capacity.

- **Nickel alloys:** Highly caustic KOH at high concentrations requires inorganic ZrO₂ diaphragms, nickel- and zinc-based materials. Nickel alloys need to be free from chromium and iron, which could leach and end up contaminating the electrodes, which reduces efficiency and durability.
- **Water impurities:** Higher degradation due to low-quality water circulation has been observed, so the lifetime of the plant is affected as a function of operating hours. Many elements, including the diaphragm, catalysts, and other components, can be adversely affected by water impurities such as iron (Fe), chromium (Cr), copper (Cu), silicon (Si), aluminium (Al) and boron (B).

PEM electrolyzers have reported lifetimes of more than 50 000 hours. Some of the factors affecting their lifetime are:

- **Operating conditions:** Higher temperature, pressure and current density can have a negative impact on lifetime. Mild conditions are 50-60°C, 10 bar and 2 ampere per square centimetre (A/cm²) respectively, while the next generation PEM is expected to run at more demanding conditions (80°C, 70 bar and 5 A/cm²). Some solutions to handle these conditions are oversized stacks with thick membranes, high catalyst loadings and protective coatings over porous transport layers (PTLs) and bipolar plates.
- **Variable load:** Electrolyzers were previously operated with almost constant power supply to satisfy a fixed demand. The coupling with variable renewable electricity will lead to a variable load, which results in voltage fluctuations that can potentially trigger additional corrosion of stack components and reduce durability. Though very true in PEM fuel cells, there is little evidence of this in PEM electrolyzers.
- **Gas permeation:** The membrane is subject to a large differential pressure (if it is operated under this) that negatively affects membrane mechanical stability. This also increases gas permeation, which can potentially lead to further degradation issues. A measure to tackle this is to use an additional catalyst to reconvert the permeated hydrogen (to the oxygen side) back to water.
- **Anode dissolution:** Iridium oxide on the anode can be prone to dissolution depending on the temperature, voltage and electrode architecture. One solution is to use a larger amount of catalyst (> 5 milligrammes per square centimetre [mg/cm²] or 2.5 grammes per kilowatt [g/kW]) and additional high loadings of precious metals in protective layers over the stack components. The anodic PTL uses porous titanium with a thickness above 1 mm to support the membrane, especially under differential pressure. This PTL is typically coated with platinum (> 1 mg/cm² or 0.5 g/kW) to minimise or mask the titanium oxidation.
- **Water impurities:** Poor water quality is one of the main reasons for stack failure for PEM electrolyzers. Higher degradation due to water circulation is seen at partial load, so the lifetime of the plant is affected as a function of operating hours. Many elements are quickly affected due to impurities such as membrane, ionomer in the catalyst layer, catalysts, and PTLs. The water purification unit, responsible for providing American Society for Testing and Materials (ASTM) type II water, contributes to lower efficiency.

SOEC electrolyzers can achieve lifetimes of 20 000 hours, but under constant power and well-defined operating conditions (*i.e.* not coupled to variable renewable energy [VRE]). The main degradation mechanism is the thermal cycling, due to the high operating temperatures and need to cool down in case of dynamic operation. Reversible operation of solid oxide cells (electrolysis + fuel cell) could help increase the hours of operation and thus keep the system at operating temperature. Deploying SOEC at large scale would require larger cells than currently used (up from 300 cm² to more than 1000 cm²), which renders them more prone to failure. Another important aspect is silica contamination and the instabilities of sealing concepts.

AEM electrolyzers suffer from a short lifetime, while limited information about their long-term operation, reliability and robustness is available. The stability of the AEM polymer used to fabricate membrane and catalyst layers is well recognised as a major issue, especially when operated with KOH as the supporting electrolyte. The main degradation mechanism is hydroxide (OH⁻) attack on the polymer backbone, which leads to membrane collapse and catalyst layer dissolution within a few days. One solution is cross-linking chemical methods, but this comes at a cost of cell efficiency. Another approach is by operating the stack without a supporting electrolyte (*i.e.* using only pure water), which can lead to a durability beyond 5 000 hours, but this results in much lower efficiencies, or current densities.

Efficiency of a hydrogen production facility

The system efficiency of a green hydrogen production facility, measured in units of kilowatt hours consumed per kilograms of hydrogen produced ($\text{kWh}_{AC}/\text{kgH}_2$), is a result of the individual efficiencies of the cell, stack and balance of plant, as follows.

- **Cell:** The efficiency profile decreases linearly from lower to higher load levels, so the higher the current input, the lower the stack efficiency. Naturally, the higher the hours of operation, the lower will be the efficiency due to degradation, though the aforementioned dynamic remains. At the operational level, the cell voltage is the element actually measured to infer the system performance, in such a way that, the higher the cell voltage, the lower the stack efficiency. Alkaline and PEM operate at different power density ranges, which has an impact on each technology's footprint:
 - **Alkaline:** Typically operates in a range of 0.2-0.8 A/cm², since the diaphragm and electrodes are not manufactured to operate at higher current densities.
 - **PEM:** Operates at higher current densities compared to alkaline, of about 2.0-2.3 A/cm², though more efficient at 1.6 A/cm² (with 1 MW as reference).

- **Balance of plant:** A range of system elements such as cooling, purifiers, thermal management, water treatment and others, consume power in order to operate, which also needs to be considered in the facility's overall efficiency. Efficiency losses can be minimised by: designing the electrolyser facility while taking a whole-of-system perspective; using commercially-available components rather than custom made ones; and maximising system efficiency including balance of plant, tailored for the specific application. Rectifiers are a key component of the balance of plant. Rectifiers generally have very low efficiency at lower loads, rapidly improving until 15%-20%, which then remains relatively high from this point on. For this reason, the balance of stack efficiency can be improved by using the same rectifier for multiple stacks. This approach would reduce the number of rectifiers needed (investment costs) while also maintaining operation at higher efficiency levels, suitable in particular for hydrogen facilities of 20 MW or larger. As a drawback, the system becomes less flexible and, therefore, such a setting would be recommended for facilities operating at flat power input/hydrogen production levels.

At very low loads (marginally above zero), when water starts circulating, the system efficiency is low because equipment is already in operation, but production has not started yet, or is very minimal. From this stage to roughly 30% load, efficiency progressively increases and peaks at this level. Beyond 30% load, the overall system efficiency starts to decrease towards the nominal rate value.

This behaviour is different than in, for example, many thermal power plants, which exhibit reduced efficiency with lower than nominal loads. It also presents a new feature that changes the operational strategy of the electrolyser. This can be operated at a lower-than-design load, benefiting from a higher efficiency (*i.e.* lower electricity cost per unit of hydrogen), at the expense of lower hydrogen production (and lower total revenues). Therefore, there is a tradeoff between capital and operational cost that should be considered at the project level.

As presented in Chapter 3, Section 3, compressors,

storage and subsequent stages of the hydrogen supply chain will naturally impact the overall efficiency, from renewable power to the hydrogen actually consumed. Naturally, the fewer the conversion stages over the chain (compression,

liquefaction, embedding in liquid organic hydrogen carriers and others), the higher will be the overall efficiency.

2.5 FLEXIBILITY OF GREEN HYDROGEN PRODUCTION FACILITIES

To ensure that green hydrogen supply cost is as low as possible, a holistic approach needs to be applied to system design and operations. System design can be optimised to minimise cost and increase flexibility as necessary, depending on a variety of factors. These can include: the variability of electricity supply (*i.e.* constant consumption of grid electricity, or direct feed from variable solar or wind farms); the technology used for the stack (*e.g.* alkaline, PEM and AEM being more flexible than solid oxide); and the flexibility of hydrogen demand (*e.g.* constant demand for chemical processes, general annual demand for export without hourly or daily constraints). Storage can significantly help to decouple variable supply from hydrogen demand. This can come in the form of

electrochemical storage for shortterm fluctuations (before the electrolyser stack), or in the form of hydrogen storage for long-term fluctuations (after the stack, before the downstream offtaker). Similarly, hydrogen storage in tanks, caverns and pipelines can help decouple variable hydrogen production from inflexible hydrogen demand (*e.g.* to produce ammonia). No single blueprint exists, however, the type of electricity supply and hydrogen demand will drive system design, where no single electrolyser technology is better than any other, as the combination with electricity and hydrogen storage can effectively provide any level of flexibility, as illustrated in Figure 15.

Figure 15. System schematic for green hydrogen production facility that includes electricity and hydrogen storage on site.

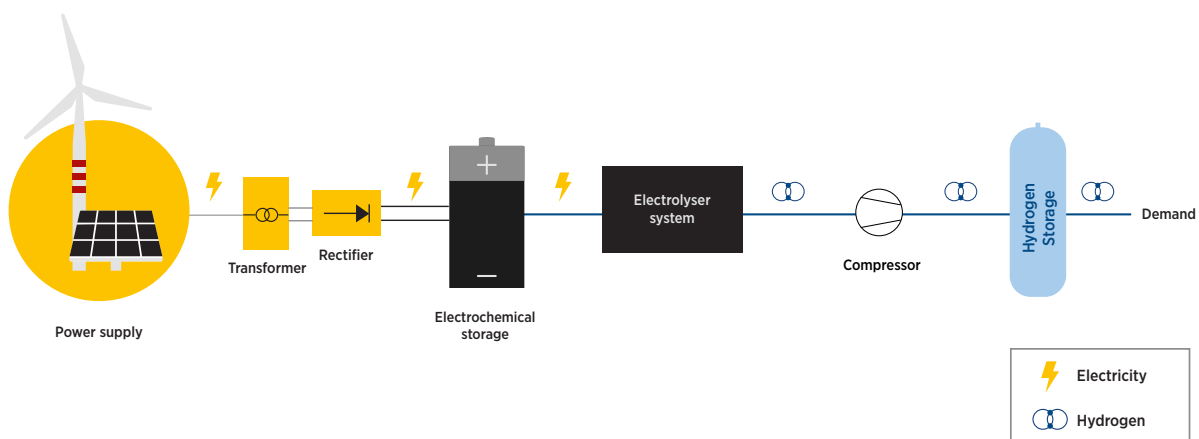

Based on IRENA analysis.

Both alkaline and PEM electrolyser systems have been certified to provide primary reserves (*i.e.* the most rapid, short term grid service) (IRENA, 2019b; thyssenkrupp, 2020), therefore highlighting how flexibility is more of a design issue related to balance of plant components and sizing. Many small modular stacks, for example, each one with its own rectifier, make a significantly more flexible electrolyser plant than a single large stack with single rectifier, regardless of stack technology.

In terms of hydrogen storage, hydrogen in a gaseous form can be stored in two favoured approaches: pressurised steel tanks and underground reservoirs. Hydrogen can also be liquefied. This would deliver about 75% higher energy density than gaseous hydrogen stored at 700 bar, while requiring the equivalent of 25%-30% of the energy contained in the hydrogen. Promising developments in large scale facilities show energy consumption as low as 6 kWh/kg of hydrogen (Walnum et al., 2013). Underground storage of hydrogen using, for instance, salt caverns is considered to be the most appropriate solution to store hydrogen on a large scale. This method comprises some interesting storage characteristics, such as low investment costs, high sealing potential, and low cushion gas requirement (Ozarslan, 2012). Salt caverns typically allow storing hydrogen from 100 bar up to 275 bar.

Hydrogen storage at output pressure from the electrolyser is useful, if the objective is to maximise flexibility, as mechanical compression can limit the speed at which electrolyser output can change. The use of pressurised electrolysers (*e.g.* 30 bar, achievable with both alkaline and PEM technologies today), in combination with a buffer to decouple the electrolyser operating regime from the compressor operating regime, helps to prevent the compressor from becoming the bottleneck for the flexibility of the electrolysis facility as a whole.

As far as the ability of electrolysers to provide flexibility to the power system, this can be achieved at multiple time scales. A mapping of system services (IRENA, 2020f) is provided in Figure 16. Except for the provision of inertia, electrolyser facilities can provide all system services, if designed with this in mind. While PEM might eventually be

more effective than alkaline for fast frequency response (FFR), batteries are clearly more efficient and effective in providing fast response to system operator's signals and can quickly saturate such a market, which makes any additional cost incurred for designing electrolyser facilities capable of providing FFR questionable in terms of potential return. For the remaining services, all electrolyser technologies can provide them effectively without technical challenges, provided they are designed with grid service provision in mind.

The electrolyser stack is fast enough to follow fluctuations from wind and solar. The limitation arises from the surrounding equipment. Seasonal rather than short-term may be hydrogen's highest value

Where hydrogen has a significant role to play in terms of flexibility provision in future decarbonised power systems is in long duration storage and system adequacy. The seasonality of solar, wind and hydropower resources can provide challenges in terms of adequacy – if not every year, at least in unusual weather years (*e.g.* dry years, or years with extended periods of low wind). Hydrogen from renewable power can be stored cost effectively – for example, in salt caverns – and can be used for power generation in these particular periods (Diesendorf and Elliston, 2018).

Notably, if hydrogen-to-power is performed using gas turbines or internal combustion engines, hydrogen can then also contribute to the provision of system inertia (unlike fuel cells).

Based on IRENA analysis, in the Transforming Energy Scenario (TES) of the Global Renewables Outlook a significant capacity of electrolysers will be deployed by 2050. IRENA developed a global power system model based on this scenario that includes electrolysers as purchasers that buy electricity when it is most affordable, with the objective of producing hydrogen. In the 2050 TES scenario, renewables will supply 86% of total electricity, with solar and wind alone providing over

60%. Due to the near-zero short run marginal cost of solar and wind, when they reach significant generation share in a market interval (e.g. in a one-hour period), they drive down electricity prices. Figure 17 shows how hydrogen production follows renewable electricity availability, highlighting an important seasonality in the production of hydrogen.

The key message is that hydrogen production from electrolyzers can be uniquely positioned to provide seasonal flexibility to the power system – something

that no other resource can effectively provide.¹⁴ This can play a significant role in balancing a power system with high shares of solar and wind, not only instantaneously and intra-day, but also across seasons. To be able to provide such services, electrolyzers must be designed not to operate at full capacity the entire year, but rather to purchase electricity when green¹⁵ and affordable. This is only possible if they are sufficiently oversized to avoid purchasing non-renewable electricity, or prohibitively expensive electricity, just to be able to meet hydrogen demand.

Figure 16. Power system services that can be provided by energy storage.

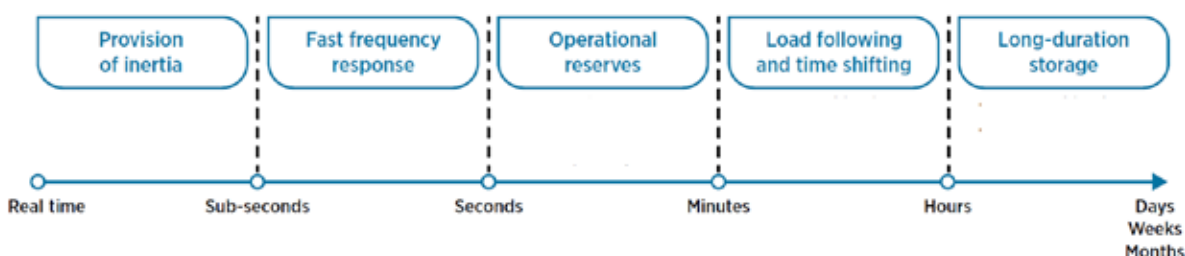

Based on IRENA analysis, 2020f.

Figure 17. Seasonality of hydrogen production in Europe in the IRENA global power system model for 2050 (based on the TES).

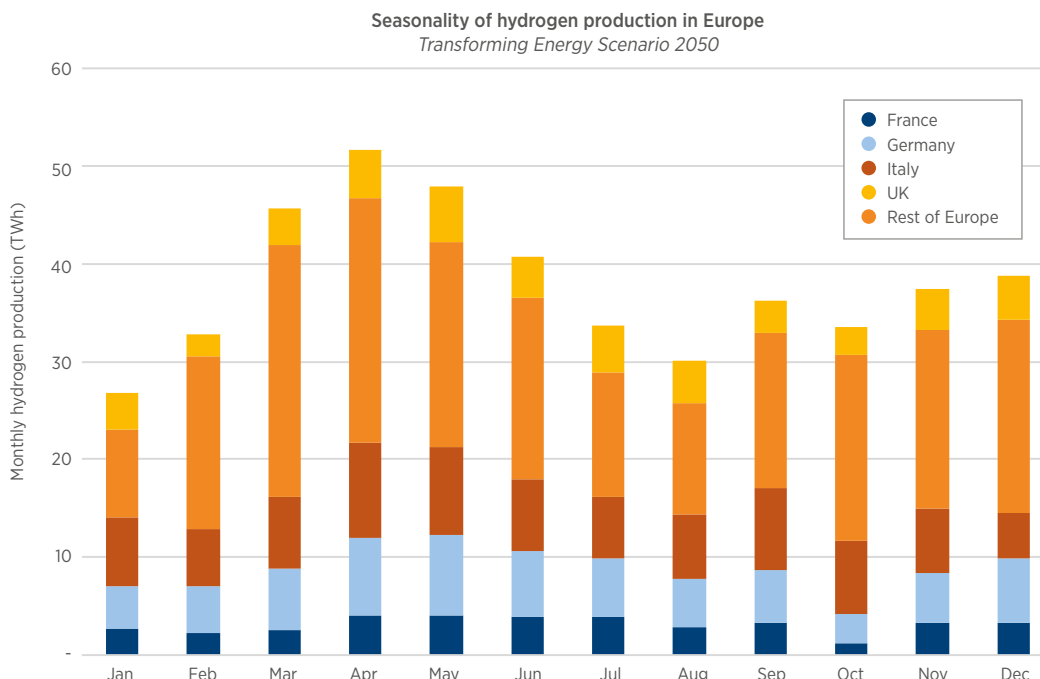

Based on IRENA analysis.

14 Hydro power can provide seasonal flexibility. Uncertainty about future availability of water, however, makes multi-season hydro power scheduling one of the most complex stochastic problems in power systems, while electrolyzers can simply respond to day ahead as well as intra day electricity prices and provide the same seasonal flexibility when coupled with hydrogen storage.

15 Appropriate mechanisms such as Guarantees of Origin are required to certify that green hydrogen is indeed produced exclusively with renewable electricity. New electrolysis capacity, however, must fundamentally be accompanied by new renewable capacity to provide the necessary green electricity.

Hydrogen can be stored and transported in multiple ways. In terms of flexibility services, electrolyzers have been evaluated in terms of:

1. The time they take to respond to a change in power set-point.
2. The time they take to settle after a power set-point change.
3. The rate at which they can change power consumption.
4. The lower operation limit, or the minimum turndown level.
5. The time they take to start up and shut down.

A report (Eichman, Harrison and Peters, 2014) has found that:

1. Small electrolyser systems (around 40 kW units) begin changing their electricity demand within milliseconds of a set-point change.
2. The settling time after a set-point change is in the order of seconds.
3. Electrolyzers can reduce their electrical consumption to zero for an unlimited amount of time.
4. Electrolyzers exhibit low partload operation capabilities.
5. Electrolyzers can start up and shut down in several minutes.

The study also concluded that electrolyzers acting as demand response devices can respond sufficiently fast and for a long enough duration to participate in energy management on the utility scale and at end user facilities. This has also been presented in some real applications by IRENA (IRENA, 2019b).

From the point of view of short-term flexibility, alkaline and PEM water electrolyzers still present the most interesting technical capability, as they have

proven to provide very fast dynamics among all available electrolysis process. Alkaline electrolyzers have been successfully tested for primary control reserve in Germany, which demonstrates that for practical purposes, these are as fast as PEM (thyssenkrupp, 2020) . All manufacturers have typically guaranteed ramping up and down to change the consumption of electricity to be completed in less than one second (ITM Power, 2017; Siemens, 2020), and that is primarily a function of the rectification system. They can also operate at partial load as low as 5%, which can be sustained during long periods of time, although this might lead to significant efficiency losses due to the rectifier's characteristics. In addition, PEM electrolyzers can reach cold startup in less than 5 minutes, and completely shut down within a few seconds. The cited technical characteristics open up several potential demandside response schemes to support the operation of electrical power systems. For instance, fleets of electrolyzers could be controlled to quickly ramp-up their consumption at times when there is a surplus of renewable energy generation, hence contributing to the minimisation of electricity curtailment, or simply participating in balancing markets either individually (if sufficiently large) or through aggregators. On top of that, they could be coordinated with renewable energy sources to help mitigate the fluctuations of the generated power in offgrid applications.

For congestion management, large scale electrolyzers can contribute to the reduction of critical peak loads by reducing their electricity demand, or even by completely interrupting operation. This service should be remunerated adequately, however, to compensate for the economic incentive to operate the electrolyser as many hours as possible to reduce the contribution of the investment cost to the total cost. Moreover, such an application can also have its limitations, since several industrial processes cannot be stopped when integrated with the electrolyser facility, therefore limiting flexibility of operations based on the size of the hydrogen storage.

The key message is that hydrogen production through electrolysis can provide significant flexibility to match the seasonality of renewable energy generation, rather than follow short-term fluctuations, which can be provided by short-term storage technologies like batteries (including those in battery electric vehicles). The coupling with gas infrastructure (including salt caverns and pipeline systems) can provide extremely large energy storage volumes to perform seasonal energy storage of renewable electricity in molecular form, effectively decoupling hydrogen (and Power-to-X) demand from variable renewable electricity supply.

This de facto provides the largest contribution to power system flexibility in terms of volume of all sources. For such system service, the speed of response of different electrolyser technologies is irrelevant, although both PEM and alkaline have been certified to provide primary reserves.

Flexibility provided by large deployment of electrolysers into high renewable power systems will be a fundamental pillar of the transformation of the power sector, in combination with a set of other technologies, such as batteries (including in electric vehicles [EVs]), hydropower and pumped hydro, and demand response.

2.6 COSTS: CURRENT STATUS

Despite their market availability and maturity, PEM and alkaline water electrolysers are still considered highly expensive from both CAPEX and OPEX perspectives, compared to fossil fuel-based hydrogen production. PEM water electrolysers are 50%-60% more expensive than alkaline (see Chapter 3, Section 2), representing an additional barrier to market penetration. Both are still considered to have untapped potential for cost decrease when considering economies of scale, automation, an increase in availability of components from various OEMs, massive market demand and deployment for energy storage (coupling electrolysers with underground storage or tanks).

For AEM and solid oxide electrolysers, these cost considerations are much more challenging, as there are only a few companies responsible for their commercialisation. Moreover, many of their components are still lab-scale based, with no OEM responsible for their manufacturing and commercialisation. These are small stacks, and system sizes are only up to a few kilowatts. While these two technologies can still contribute to a low production cost of green hydrogen, they have a longer way to go compared to alkaline or PEM. For these reasons, only the cost breakdown for these two technologies is explored in more detail below. Significantly, AEM can use less-expensive materials (in particular titanium, which can represent around half the stack cost for PEM) and therefore AEM has an advantage over PEM in cost-reduction potential.

There are two main problems with cost estimates for electrolyzers. First, the availability of data, given its confidential nature and the retention of competitive advantage. Second, the boundaries for the cost estimates are not consistent (e.g. stack, balance of plant, full system) and, in many cases, not even specified, which makes the comparison across studies more difficult. To deal with these challenges, this report performed a thorough literature review validated by consultations and a peer review with various leading manufacturers, which informed the cost breakdowns shown in Figure 18 and Figure 20. For the second barrier (boundaries), different system scopes are analysed for the cost estimates in this report:

- The first level is a single **cell** unit. This is the core of the electrolyser where the main electrochemical process takes place. This includes the catalyst coated membrane where the catalyst layers are coated directly as electrodes onto the membrane for the PEM type and the electrodes and diaphragms for the alkaline type, plus the manufacturing of these components which can represent a large share of the costs.
- The second level within **stack** costs includes the cells plus the PTLs, bipolar plates, end plates and other small parts such as spacers, seals, frames, bolts and others. This level usually represents about 40%-50% of the total.
- The third level is the **system** costs. The scope is all the balance of plant components and peripherals responsible for operating the electrolyser, but excluding any component responsible for further gas compression and storage. The major components for the balance of plant cost models typically include rectifier, water purification unit, hydrogen gas processing (compression and storage) and cooling components. These items can constitute 50%-60% of the total cost.

Today, the main contributor to system costs is still the stack, which represents 40%-50% of the total, for both alkaline and PEM electrolyzers. This share greatly depends on design, manufacturing strategy, business case, and customer specifications. Cost breakdowns for AEMs and solid oxide systems

are still not available, due to the limited number of systems that have been deployed commercially.

A paper published in 2018 (Saba et al., 2018) showed a comparison of cost studies from the previous 30 years, and projections of these costs for PEM and alkaline electrolyser systems. The study showed there had been significant cost reductions over the period for both PEM and alkaline systems, but this reduction was more pronounced for PEM. Saba et al. depict a significantly large spread in the costs of PEM systems, ranging from USD 306/kW up to USD 4 748/kW, demonstrating the challenge of finding representative numbers for the current system costs (Saba et al., 2018).

Figure 18 and Figure 20 show a breakdown of cost components for both PEM and alkaline electrolyzers, while Figure 19 and Figure 21 combine this information with the potential for cost reduction of the various items in order to identify priority areas for innovation and deployment. First scalingup initiatives into systems larger than 1 MW will allow quick cost reduction of balance of plant components, as discussed above. Beyond this point, innovation becomes key for any further significant cost reduction. Most of the stack components are still over designed, and significant potential for cost reduction can be found for PTLs, bipolar plates and the highly expensive protective coatings on these.

Figure 18 shows that for PEM electrolyzers the stack represents slightly less than half of the electrolysis system cost. For the balance of plant, power supply represents a very significant cost component.

For PEM stacks, bipolar plates are a significant cost component, as they are often built to provide multiple functions and require advanced materials such as gold or platinum coated titanium (Hermann, Chaudhuri and Spagnol, 2005). This is one of the areas where innovation can play an important role in both performance and durability enhancement, as well as cost reduction. Research is ongoing to replace titanium with cheaper materials, relying on the coating for its functional characteristics to remain unaffected, while reducing cost.

For the core of the stack, the catalyst coated membrane (CCM), rare metals represent an important part of the cost. Put into context, however, they represent less than 10% of the cost of a full PEM electrolysis system. Yet, for iridium

in particular, they might represent a bottleneck for scaling up manufacturing of PEM electrolyzers, in the absence of a significant scale-up of iridium supply (see Chapter 3, Section 3).

Figure 18. Cost breakdown for a 1 MW PEM electrolyser, moving from full system, to stack, to CCM.

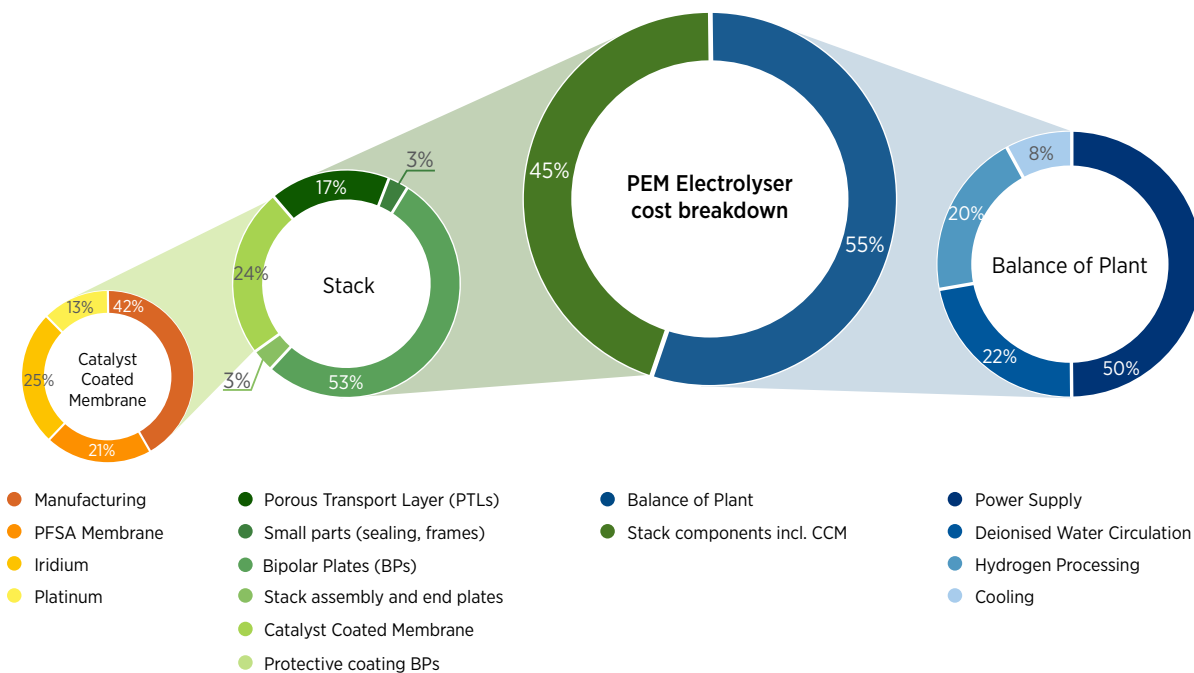

Note: The specific breakdown varies by manufacturer, application and location, but values in the figure represent an average.

Based on IRENA analysis.

When the dimension of potential for cost reduction is combined with the current share of total system cost of each component, some clear priority areas for innovation emerge. Power supply is the single largest area where cost reduction could be achieved (see Figure 19). Bipolar plates, although with a lower cost reduction potential, also represent

almost a quarter of the total PEM electrolysis system cost and should be a priority area. Other balance of plant components, like water circulation and hydrogen processing, also represent important areas where cost reduction can be achieved.

Figure 19. System components for a 1 MW PEM electrolyser classified based on contribution to total system cost and potential for cost reduction.

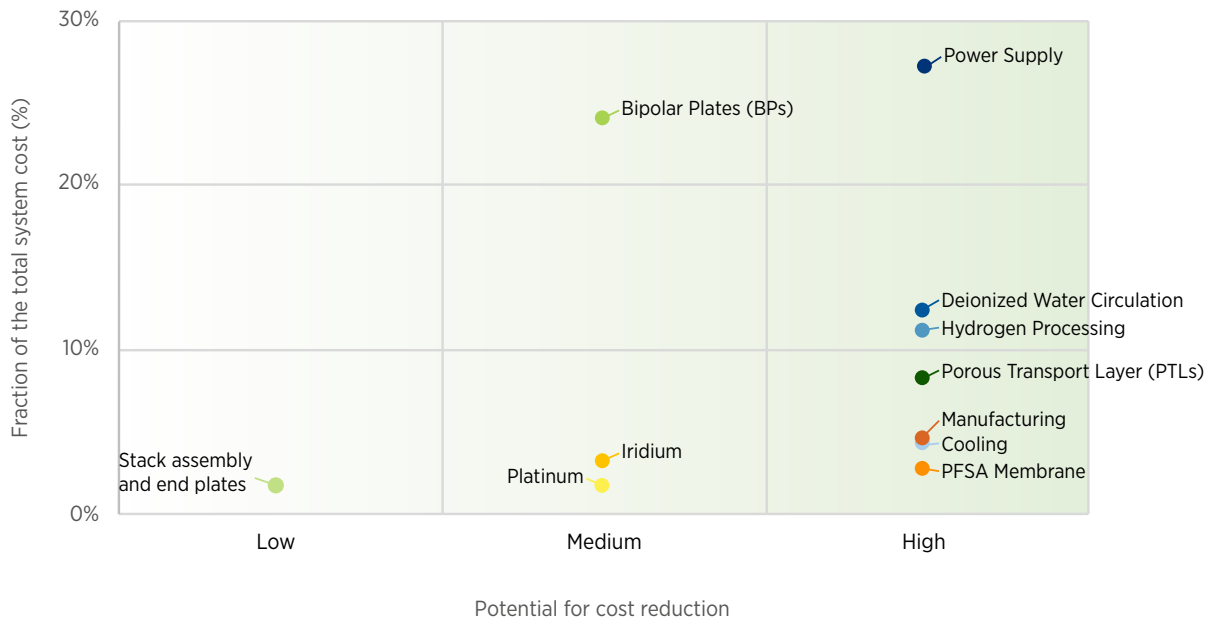

Based on IRENA analysis.

For alkaline electrolysers, the same reasoning in reducing the costs of the balance of plant components applies. As illustrated in Figure 20, within the stack, over 50% of the costs relate to electrodes and diaphragms, as opposed to 25% of the cost in the CCM for PEM. Significant cost is associated with manufacturing of the electrodes (E4tech, 2014; NOW, 2018) where learning-by-

doing, automatisisation of the manufacturing process and economies of scale can play an important role in cost reduction. Bipolar plates for alkaline, however, account for only a small part of stack costs, as opposed to over 50% in the case of PEM, due to a simpler design, simple manufacturing and cheaper materials (nickel-coated steel) for bipolar plates in alkaline stacks.

Figure 20. Cost breakdown for 1 MW alkaline electrolyser, moving from full system, to stack, to membrane electrode assembly (MEA).

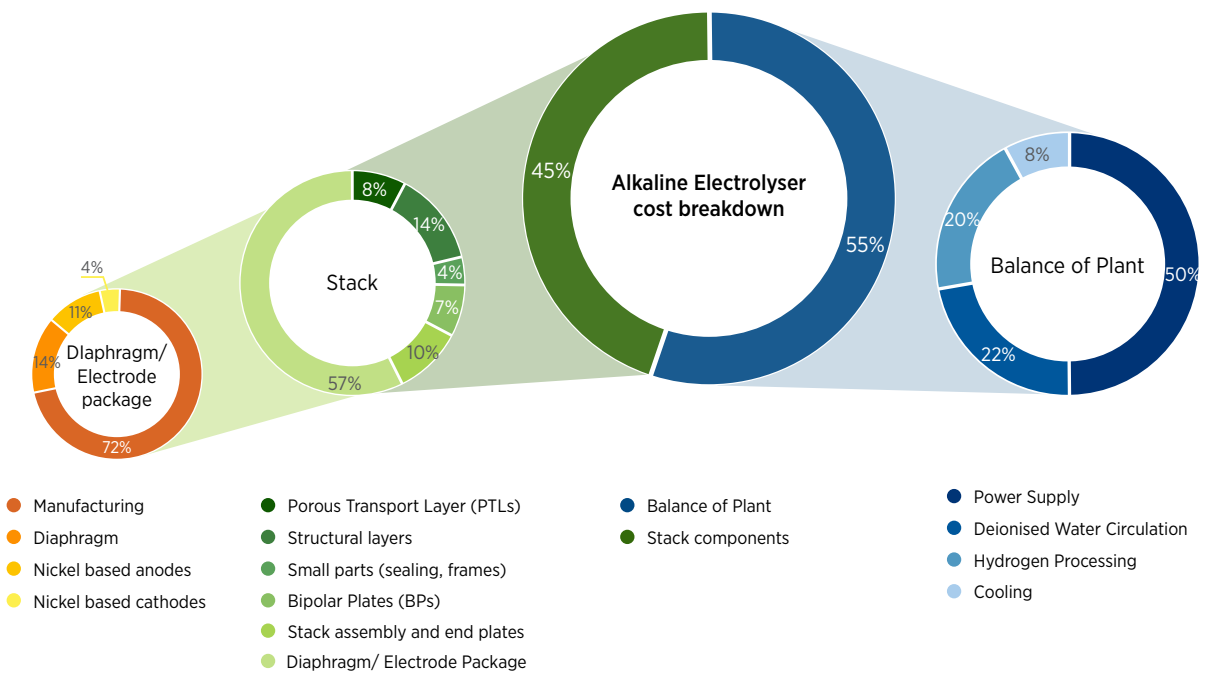

Note: The specific breakdown varies by manufacturer, application and location, but values in the figure represent an average.

Based on IRENA analysis.

Similar to what happens with PEM, some clear priority areas arise for alkaline electrolyzers when the potential for cost reduction is combined with the current share of total system cost of each component (see Figure 21): power supply is the single largest area where cost reduction could be achieved, followed by the manufacturing of the electrodes and diaphragms. The strategy can be to

completely reengineer them, demonstrating CCM concepts similar to the PEM type, where a single component comprised of membranes, electrodes, and eventually PTLs, is fabricated. Balance of plant items, such as lye circulation and hydrogen processing remain important for alkaline too, although no significant potential for reduction in the cost for materials has been observed.

Figure 21. System components for a 1-MW alkaline electrolyser classified based on contribution to total system cost and potential for cost reduction.

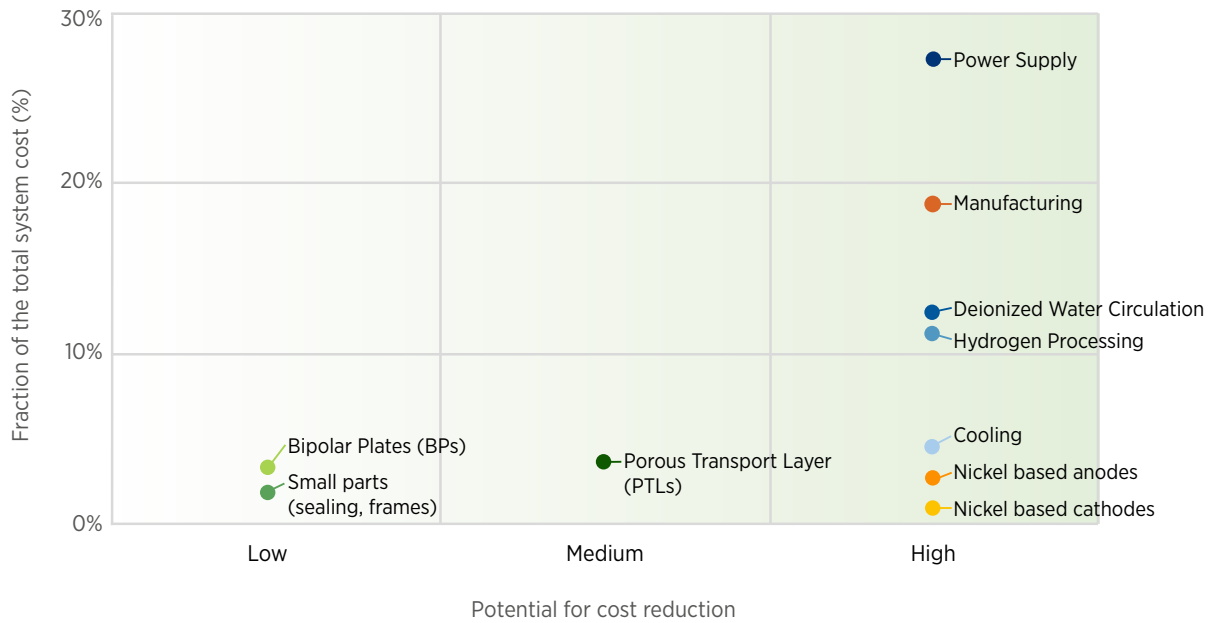

Based on IRENA analysis.

3.

STRATEGIES FOR COST REDUCTION: STACK LEVEL

KEY POINTS

- Government support for research programmes is needed to continue improving commercially available technologies and make potential breakthroughs in emerging technologies. The key areas of focus for this research are identified in this section.
- Given the difference in design and maturity for the different technologies, the use of comparable performance indicators seems to be a suitable approach to guide innovation efforts. These performance indicators, including the long term targets defined in this section, can be used by governments to benchmark performance of funded projects and to set research programme goals.
- To prevent critical materials from becoming a barrier to scaling up, alkaline systems need to transition to platinum and cobalt free designs. This is already commercially available from some manufacturers today; yet, it has to become a prerequisite for policy support before scaling up manufacturing capacity. For PEM electrolyzers, further efforts are needed to reduce the platinum and iridium content by at least one order of magnitude and, if possible, in the future, replace these with more common materials. Titanium is also a significant cost component that should be reduced in use. Although less scarce than other materials, it is still required in significant quantities for current PEM designs.
- Increasing the facility size can have the largest cost reduction effect on the balance of plant. Yet, facility size is not defined based on cost only, but is also based on the application (e.g. the residential or transport sectors use smaller sizes than industrial applications). Higher cost due to smaller scale can partly be offset by savings in the delivery of the hydrogen, due to on-site production.

At the stack level, there are mainly two strategies to achieve a lower costs:

- **Stack design and cell composition:** This includes using less critical materials, redesigning the stack to achieve a higher efficiency (*i.e.* lower electricity cost), higher durability (longer lifetime to distribute the investment) and increase the current density (higher production rate).
- **Increase the module size:** This can bring economies of scale to some of the balance of plant components. This strategy should consider a trade-off between a small module size that enables mass-manufacturing, standardisation and replication, and a large module size that achieves larger cost reduction in balance of plant components at the expense of fewer units deployed and less learning by deployment.

3.1 STACK DESIGN: WHAT CAN BE DONE?

Alkaline electrolyzers

Concerning stacks for alkaline electrolyzers, the key areas to focus on are the electrodes and the diaphragms. Bipolar plates and PTLs have less priority, since they are based on stainless steel plates coated with nickel, which are already significant, cost-effective components. Strategies to integrate PTLs into electrodes and consequently diaphragms can also be of key importance in reducing costs, as outlined below:

Increase current densities: The current densities of the stacks can be increased, from the current, 0.5 A/cm² to more advanced units of 2-3 A/cm². This current density increase cannot be made, however, at the penalty of lower efficiency.

Higher current densities have already been accomplished by some manufacturers, too, with electrode-separator packages that can deliver a performance range as high as 1.2 A/cm² at 2 volts (V) now available. Power densities of 2-3 W/cm² could be achieved by demonstrating thinner diaphragms or membranes for alkaline electrolyzers. As with PEM, alkaline electrolyzers also need to improve their voltage efficiency levels, reducing ohmic losses and increasing electrode kinetics.

Reducing diaphragm thickness: This could improve efficiency and reduce electricity consumption. The thinner the diaphragms, the lower the resistance to transporting the OH⁻ species from the cathode to the anode. Eventually, however, this comes at a cost of higher gas permeation, which contributes to higher safety concerns. The other downside is the lower durability, given the higher chance of pinhole formation in the diaphragm and less mechanical robustness. Overall, the diaphragm thickness should reach values that approach those of PEM and AEM. State-of-the-art membranes for PEM are about 125-175 micrometres (µm) (Babic, 2017) with a potential decrease to 20 µm or lower. Below this point (for PEM), there are limited efficiency benefits. For alkaline electrolyzers, the current diaphragm thickness is about 460 µm. Decreasing this to 50 µm would contribute to improving the efficiency from 53% to 75% at 1 A/cm² (see Figure 22).

Figure 22. Relationship between voltage (the higher, the lower the efficiency) and current density (the higher, the higher the production volume) for various diaphragm thickness of alkaline electrolyzers.

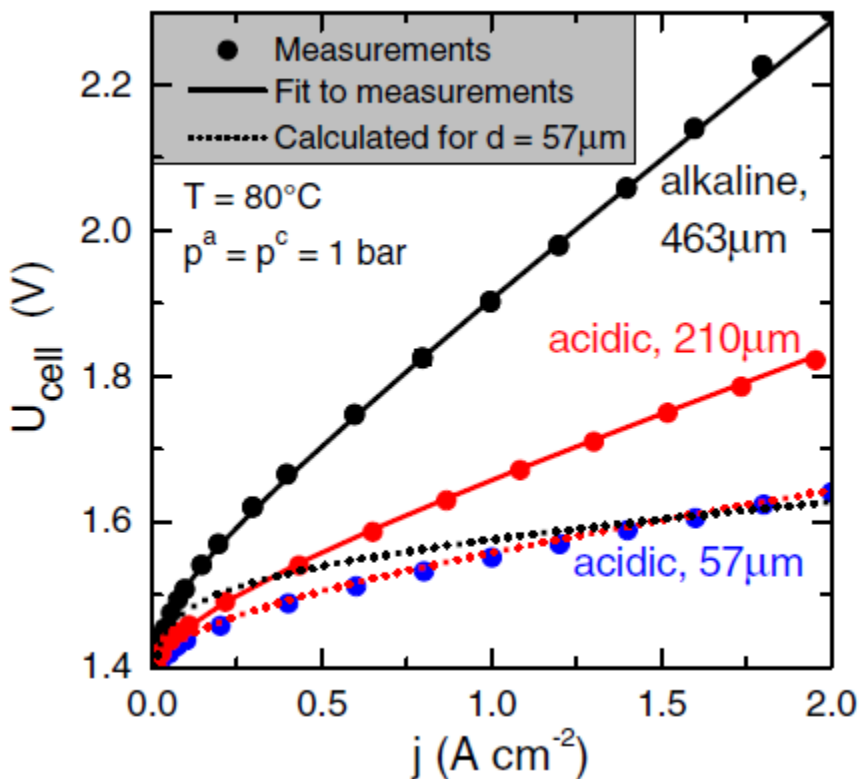

Source: Schalenbach et al., 2016.

Re-designing catalyst compositions and electrode architectures into electrodes with a high specific surface area: Despite using cheap and widely available Nickelbased catalysts for their electrodes, alkaline electrolyzers have traditionally encountered many challenges in moving away from rudimentary, or archaic electrode designs and reaching much higher efficiencies for both hydrogen and oxygen

evolution reactions. Efficiency differences with other technologies are small and best-in-class designs result in even higher efficiencies. Table 2 shows a list with the ten main R&D aspects that need to be addressed, so that electrodes used in these stacks can be transformed and implemented in more advanced stack concepts.

Table 2. Proposed activities to improve the performance of alkaline electrolyzers.

	CHALLENGE	BENEFIT
1. High catalyst surface area > 50 m ² /g	Easy	Medium
2. High catalyst utilization > 80%	Moderate	Medium
3. Improved kinetics for both hydrogen and oxygen evolution with novel nickel-based alloys	Moderate	High
4. Mitigate catalyst poisoning/deactivation by foreign elements from electrolyte, and components present in the system	Moderate	Low
5. Design, create, and integrate forms of recombination catalysts for gas permeation (crossover)	Moderate	Medium
6. Mitigate critical degradation of catalysts on the anode side to avoid loss of surface area	Difficult	High
7. Mitigate nickelhydrogen (NiH) formation on the cathode side	Difficult	Low
8. Eliminate mechanical degradation of catalyst layers (delamination, dissolution)	Difficult	High
9. Identify stable polymer chemistry that can be used as ionomer (OH ⁻ transport) to be used to fabricate electrodes for alkaline electrolyzers	Difficult	High
10. Identify and reduce interface resistances from catalyst layer to PTLs	Difficult	High

Based on IRENA analysis.

Apart from increasing surface area, which was traditionally and simply achieved with Raney-Ni catalysts (nickel-aluminium [Ni-Al], or nickel-zinc [Ni-Zn]), the other points are considered moderate and difficult challenges. In addition, any novel concept still needs to keep long-term durability, comparable to those presented by current nickelcoated stainless steel perforated sheets. That is the reason why Raney-Ni electrodes have not been commercially deployed, at least not in large-scale electrodes, since they have presented some critical durability aspects for

long-term operation (low mechanical robustness) and much higher costs, due to the use of expensive manufacturing techniques.

Novel PTL concepts: Alkaline electrolyzers are also not well developed in the use of efficient PTLs, potentially based on nickel. This is especially so in regard to optimising these for reduction of mass transport limitations (e.g. gas bubble resistance, trapped inside alkaline PTLs), and optimal protective coating alternatives to decrease interface resistances on the anode side.

PEM electrolyzers

For PEM stacks, the focus areas are bipolar plates and PTLs, given their large cost contribution and large potential for reduction. Based on these two criteria (cost share and potential), the catalyst-coated membrane is the next priority.

Re-designing the stacks can achieve large cost reductions, since it enables the reaching of higher power densities, up from the current (conservative) 2 A/cm² to 6 A/cm² or more in the next few decades. Next, electrodes should be scaled up from the current 1500-2 000 cm², up to 5 000 cm² and eventually 10 000 cm². The larger area should go in tandem with more mechanically robust membranes that can use the same thickness. Such a strategy would allow an increase in the size of the PEM stacks, from the current 1 MW/unit to next generation stacks of 5 MW or even 10 MW per stack. These need to run at much lower levels of cell voltage to allow for an increase in efficiency and the simplification of waste heat management.

Reducing membrane thickness: This enables an increase in efficiency, which in turn enables a reduction in electricity consumption. Thick membranes (Nafion N117 with approximately 180 µm thickness, for example) are still state-of-the-art and are responsible for efficiency losses of about 25% (at 2 A/cm²). There are much thinner membranes that are commercially available, with thicknesses as low as 20 µm, yet these are not designed for electrolysis requirements. This thickness reduction would allow a reduction in efficiency losses to about 6% (at 2 A/cm²). Further reduction of membrane thickness, down to 5.0 µm or lower (membraneless electrolysis), is not encouraged, since a decrease of no more than 0.5 kWh/Kg H₂ can be extrapolated. In this case, R&D is therefore not justified. Looking at the experience in PEM fuel cells (reverse process of electrolysis), commercial stacks are already equipped with membranes that are 810 µm thick, as gas permeation is not a concern, since they operate at much lower pressures (36 bar) on the air side.

The two challenges that arise with thinner membranes are: their lower durability, given their potentially lower mechanical strength and being more prone to defects and pinhole failures; and the manufacturing of such membranes. During manufacturing, the process of enlarging the catalyst-coated membranes and porous transport layers into large electrodes is challenging and therefore of high R&D risk. The thin membrane and electrodes need to be mechanically stabilised over the full area to avoid undesired mechanical stresses that can tear these films and delaminate thin electrodes. This is especially critical at differential pressure operations, where one side is subjected to much higher pressures coming from the other electrode. Re-designing PTLs will be crucial – *i.e.* with finer structures at the catalyst interface that can better support a thinner membrane and prevent creep failure, thereby enabling lower membrane thickness.

Removing expensive coatings and redesigning the PTLs and bipolar plates: On the anode side, commercial stacks demand the use of platinum-coated titanium porous sintered PTLs, which is not possible with non-PGMs at this stage. Platinum loadings on the anodic PTL vary from 1-5 milligrammes per square centimetre (mg/cm²) or 1 2.5 g/kW. Platinum has a dual purpose: to protect the titanium against passivation¹⁷ and provide an optimal interface resistance. This is needed because titanium is prone to severe quick and detrimental passivation. Studies have shown that interface resistance at the PTL is responsible for an electricity consumption as high as 1.35 kWh/Kg H₂ (4% of hydrogen LHV) (Liu et al., 2018; Kang et al., 2020). The bipolar plates made of titanium also possess protective layers of platinum on the anode side, and gold on the cathode. Alternatives are needed for titanium plates, based on such materials as niobium, tantalum and eventually stainless steel approaches, but using protective coatings that are stable and also free from platinum or gold.

Re-designing catalyst-coated membranes: For catalyst coated membranes (electrodes), the strategy can be divided into different timescale scenarios. An initial approach could be to tackle

17 'Passivation' refers to a material becoming less affected or corroded by the environment.

the economies of scale for CCM fabrication via automation over manufacturing, establishing more reliable and less expensive supply-chains for catalysts and membranes, and implementing quality control. If possible, parallel work can be done to reduce the amount of electrocatalysts by re-engineering the electrodes over the membrane.

Supply chain for PFSA membranes: For PFSA membranes, various suppliers (e.g. Chemours, Solvay, Asahi-Kasei, 3M and Gore) are available. This is also one of the most solid supply chains for PEM

components. Moreover, these membranes have been traditionally supplied at scale for chloroalkali electrolyzers, with membranes reaching areas as high as 3 m². Therefore, significant cost reduction is expected as soon as PEM water electrolyzers reach high market volumes.

Table 3 shows a list with the main R&D aspects that need to be addressed, so that catalysts, electrodes, and stack components can be transformed and implemented in more advanced PEM electrolyser concepts.

Table 3. Proposed activities to improve the performance of PEM electrolyzers.

	CHALLENGE	BENEFIT
1. Mitigate membrane poisoning/deactivation by foreign elements from components and system	Easy	Medium
2. Design, create, and integrate forms of recombination catalysts for gas permeation (crossover)	Easy	Medium
3. Increase catalyst utilisation of anode and cathode catalysts	Moderate	High
4. Identify and reduce interface resistances from catalyst layer to PTLs	Moderate	Medium
5. Reduce the ohmic losses and gas permeation of PFSA membranes	Difficult	High
6. Improve kinetics for oxygen evolution using iridium-free catalysts and maintain stability comparable to iridium SoA	Difficult	High
7. Eliminate mechanical degradation of catalyst layers (delamination, dissolution)	Difficult	Medium
8. Create noble metal free protective layers for PTLs	Difficult	High
9. Create titanium free PTLs	Difficult	High

Based on IRENA analysis.

AEM electrolyzers

In terms of components, the AEM membrane and ionomer are the main and most challenging. In terms of performance, the most critical item is durability, but also conductivity. Research efforts are targeted to finding AEM membranes with desirable properties (high mechanical, thermal, and chemical stability, ionic conductivity, and lower permeability with respect to electrons and gases). The polymer backbone is responsible for mechanical and thermal stability. The functional group that transports the OH⁻ anion is accountable for the ion exchange capacity, ionic conductivity, and transport number.

The trade-off for AEM is between mechanical stability, ionic conductivity and cost. For instance, the production of commercial AEM that achieves a high mechanical stability and high

ionic conductivity is challenging and therefore expensive. There are known chemical strategies to increase the AEM ionic conductivity, but it leads to loss of mechanical strength due to excessive water uptake. The AEM then becomes chemically unstable, which leads to poor ionic conductivity. Another major limitation of an AEM is degradation of the polymer due to KOH attack, which quickly reduces the conductivity of the membrane and ionomer within the catalyst layer. The ionic conductivity of an AEM plays a significant role in the performance of the AEM. Higher levels of ion conductivity allow much higher current densities to be achieved. Tasks to increase efficiency and durability of electrodes and PTLs are analogous to those related to alkaline electrolyzers.

Table 4 has the key areas in the stack that can lead to the largest performance improvement in AEM electrolyzers.

Table 4. Proposed activities to improve the performance of AEM electrolyzers.

	CHALLENGE	BENEFIT
1. Development of cost effective PTLs for AEM electrolyzers	Moderate	Medium
2. Identify and reduce interface resistances from catalyst layer to PTLs	Moderate	Medium
3. Control the oxidized state of electrocatalysts on the oxygen side (anode)	Moderate	Medium
4. Reducing the ohmic losses and gas permeation of AEM membranes	Moderate	High
5. Improve kinetics for hydrogen and oxygen evolution and maintain long-term stability	Moderate	High
6. Increase AEM membrane durability	Difficult	High
7. Eliminate mechanical degradation of catalyst layers (delamination, dissolution) and improve ionomer/catalyst binding properties	Difficult	High

Based on IRENA analysis.

Solid oxide electrolyzers

The potential for this technology lies in its higher efficiency, while its main challenge is durability. Some of the areas to focus on are: the improvement of electrolyte conductivity, optimisation of chemical and mechanical stability, matching the thermal expansion coefficient to both electrodes, and ensuring minimal reactant crossover. State-of-the-art electrolytes used in these cells have already exhibited remarkable conductivity for stack operation for thousands of hours, but the degradation of the electrolyte (which translates into a reduction in performance) is still of high importance for research. Structural

changes within the electrolyte accelerate the formation of voids within its structure, increasing electrolyte resistance. Moreover, electrolyte also reacts with vaporised water and forms volatile products such as nickel hydroxide ($\text{Ni}(\text{OH})_2$) that also deactivates it.

As for the other electrolysis technologies, electrodes used for solid oxide stacks are key components, and many key properties are required to provide high efficiency and durability. Table 5 provides a list of challenges and their respective ranking related to future R&D tasks to improve them, both to reach higher efficiency and durability.

Table 5. Proposed activities to improve the performance of solid oxide electrolyzers.

	CHALLENGE	BENEFIT
1. Stabilise the chemical structure and compatibility of the electrodes	Moderate	Medium
2. Control the oxidation state of electrocatalysts on the oxygen side (anode) or nickel agglomeration	Moderate	Medium
3. Increase the electro catalytic activity of electrodes at lower temperatures	Moderate	Low
4. Solve challenges related to lanthanum manganite (LSM) or lanthanum ferrite (LSF) delamination from electrolyte	Moderate	High
5. Improve kinetics for hydrogen and oxygen evolution and maintain long-term stability	Difficult	High
6. Eliminate or reduce contamination issues related to silicon dioxide (SiO_2) dissolution from stack sealants	Difficult	Medium
7. Eliminate thermal instability issues caused by an expansion coefficient mismatch between electrolytes and electrodes	Difficult	High
8. Scaling up of stack components towards larger stack MW units	Difficult	High

Based on IRENA analysis.

3.2 SETTING TARGETS FOR STACK DESIGN: A KEY PERFORMANCE INDICATOR (KPI) DRIVEN APPROACH

Table 6 lists KPIs for the four-electrolysis technologies considered here, both for the state-of-the-art in 2020 and as targets for 2050. The table also displays which main component is specifically related to, or individually affects a given KPI, and that can be used as **guideline for both the electrolyser industry and OEMs to transform the technology by 2050.**

For **PEM water electrolysers**, significant development of the technology can be obtained by:

- replacing thick membranes,
- reducing catalyst quantities after reengineering electrode concepts,
- removing or substituting expensive coatings on PTLs,
- developing novel concepts for recombination catalysts.

For **alkaline electrolysers**, the focus on increasing efficiency can be accomplished by:

- increasing the limit for the operating temperature,
- replacing thick diaphragms,
- redesigning catalyst compositions,
- moving electrode architectures into high area electrodes,
- introducing novel PTL/electrode concepts.

Alkaline electrolysers need to reach similar concepts in catalyst coated membranes or membrane electrode assemblies as used in PEM electrolysers. Such a strategy works to reduce ohmic and interface resistances and improve electrode kinetics. Any novel diaphragm or membrane concept that is fabricated needs to respect the necessary gas permeation threshold, not exceeding the current values already observed for classic alkaline electrolyser concepts.

A parallel – and equally valid – approach is to focus on designing three dimensional (3D) electrode structures, profiting from the high conductivity of KOH across the components, which goes against the development of electrodes similar to PEM.

While today, performance ranges widely by technology, these gaps are expected to close over time. A performance-driven approach serves as guidance for research and innovation

For **AEM electrolysers**, the main hurdle still lies in the complex, yet unstable polymer chemistry used in the membranes and ionomers. If a stable AEM membrane is found, novel membrane electrode assemblies using anion exchange membranes need to be proven for acceptable electrode and PTL concepts to be used within these stacks. These also need to be envisioned for membrane electrode assemblies of much larger cell area, similar to that currently observed in stateoftheart PEM electrolysers.

For all technologies, a crucial challenge is related to the long-term characteristics of any novel material or component that needs to prove reliability beyond 50 000 hours. Hence, there is an intrinsic hurdle in running durability experiments for thousands of hours, or even a few years, making R&D of these components very slow and/or inefficient.

Prior to such long-term experiments, degradation mechanisms should be unveiled for each novel component, along with accelerated stress tests and insitu/operando techniques to identify degradation issues. This challenge is related to the R&D of all electrolysis technologies, since all are aimed at stationary applications.

The research and development of materials, thin films, components, cells, stacks, systems peripherals, and integration for water electrolyzers is very much dependent on the definition of a solid and trustworthy state-of-the-art that correctly represents what can currently be found at the commercial level. Only a reliable state-of-the-art allows the implementation of solid baselines to different metrics, such as the physical-chemical characteristics of materials, performance, selectivity, durability, cost, and so on.

PEM and alkaline electrolyzers have historically relatively well-defined benchmarks, with metrics fairly well known by the R&D community and industry.

This is unfortunately not the case for solid oxide and AEM electrolyzers. These are of high potential, but are also much less mature technologies, with only a few companies and OEMs interested or involved in their manufacture and commercialisation.

Table 6. State-of-the-art and future KPIs for all electrolyser technologies.

	2020	Target 2050	R&D focus
PEM electrolyzers			
Nominal current density	1-2 A/cm ²	4-6 A/cm ²	Design, membrane
Voltage range (limits)	1.4-2.5 V	< 1.7 V	Catalyst, membrane
Operating temperature	50-80°C	80°C	Effect on durability
Cell pressure	< 30 bar	> 70 bar	Membrane, reconversion catalysts
Load range	5%-120%	5%-300%	Membrane
H ₂ purity	99.9%-99.9999%	Same	Membrane
Voltage efficiency (LHV)	50%-68%	>80%	Catalysts
Electrical efficiency (stack)	47-66 kWh/Kg H ₂	< 42 kWh/Kg H ₂	Catalysts/membrane
Electrical efficiency (system)	50-83 kWh/Kg H ₂	< 45 kWh/Kg H ₂	Balance of plant
Lifetime (stack)	50 000-80 000 hours	100 000-120 000 hours	Membrane, catalysts, PTLs
Stack unit size	1 MW	10 MW	MEA, PTL
Electrode area	1 500 cm ²	> 10 000 cm ²	MEA, PTL
Cold start (to nominal load)	< 20 minutes	< 5 minutes	Insulation (design)
Capital costs (stack) minimum 1 MW	USD 400/kW	< USD 100/kW	MEA, PTLs, BPs
Capital Costs (system) minimum 10 MW	700-1400 USD/kW	< 200 USD/kW	Rectifier, water purification
Alkaline electrolyzers			
Nominal current density	0.2-0.8 A/cm ²	> 2 A/cm ²	Diaphragm
Voltage range (limits)	1.4-3 V	< 1.7 V	Catalysts
Operating temperature	70-90°C	> 90°C	Diaphragm, frames, balance of plant components
Cell pressure	< 30 bar	> 70 bar	Diaphragm, cell, frames
Load range	15%-100%	5%-300%	Diaphragm
H ₂ purity	99.9%-99.9998%	> 99.9999%	Diaphragm
Voltage efficiency (LHV)	50%-68%	> 70%	Catalysts, temperature
Electrical efficiency (stack)	47-66 kWh/Kg H ₂	< 42 kWh/Kg H ₂	Diaphragm, catalysts
Electrical efficiency (system)	50-78 kWh/Kg H ₂	< 45 kWh/Kg H ₂	Balance of plant

	2020	Target 2050	R&D focus
Lifetime (stack)	60 000 hours	100 000 hours	Electrodes
Stack unit size	1 MW	10 MW	Electrodes
Electrode area	10 000-30 000 cm ²	30 000 cm ²	Electrodes
Cold start (to nominal load)	< 50 minutes	< 30 minutes	Insulation (design)
Capital costs (stack) minimum 1 MW	USD 270/kW	< USD 100/kW	Electrodes
Capital costs (system) minimum 10 MW	USD 500-1 000/kW	< USD 200/kW	Balance of plant
AEM electrolyzers			
Nominal current density	0.2-2 A/cm ²	> 2 A/cm ²	Membrane, reconversion catalysts
Voltage range (limits)	1.4-2.0 V	< 2 V	Catalyst
Operating temperature	40-60°C	80°C	Effect on durability
Cell pressure	< 35 bar	> 70 bar	Membrane
Load range	5%-100%	5%-200%	Membrane
H ₂ purity	99.9%-99.999%	> 99.9999%	Membrane
Voltage efficiency (LHV)	52%-67%	> 75%	Catalysts
Electrical efficiency (stack)	51.5-66 kWh/Kg H ₂	< 42 kWh/Kg H ₂	Catalysts/membrane
Electrical efficiency (system)	57-69 kWh/Kg H ₂	< 45 kWh/Kg H ₂	Balance of plant
Lifetime (stack)	> 5 000 hours	100 000 hours	Membrane, electrodes
Stack unit size	2.5 kW	2 MW	MEA
Electrode area	< 300 cm ²	1 000 cm ²	MEA
Cold start (to nominal load)	< 20 minutes	< 5 minutes	Insulation (design)
Capital costs (stack) minimum 1 MW	Unknown	< USD 100/kW	MEA
Capital costs (system) minimum 10 MW	Unknown	< USD 200/kW	Rectifier
Solid oxide electrolyzers			
Nominal current density	0.3-1 A/cm ²	> 2 A/cm ²	Electrolyte, electrodes
Voltage range (limits)	1.0-1.5 V	< 1.48 V	Catalysts
Operating temperature	700-850°C	< 600°C	Electrolyte
Cell pressure	1 bar	> 20 bar	Electrolyte, electrodes
Load range	30%-125%	0%-200%	Electrolyte, electrodes
H ₂ purity	99.9%	> 99.9999%	Electrolyte, electrodes
Voltage efficiency (LHV)	75%-85 %	> 85%	Catalysts
Electrical efficiency (stack)	35-50 kWh/Kg H ₂	< 35 kWh/Kg H ₂	Electrolyte, electrodes
Electrical efficiency (system)	40-50 kWh/Kg H ₂	< 40 kWh/Kg H ₂	Balance of plant
Lifetime (stack)	< 20 000 hours	80 000 hours	All
Stack unit size	5 kW	200 kW	All
Electrode area	200 cm ²	500 cm ²	All
Cold start (to nominal load)	> 600 minutes	< 300 minutes	Insulation (design)
Capital costs (stack) minimum 1 MW	> USD 2 000/kW	< USD 200/kW	Electrolyte, electrodes
Capital costs (system) minimum 1 MW	Unknown	< USD 300/kW	All

Based on IRENA analysis.

3.3 MATERIALS: USE, BARRIERS AND SOLUTIONS

Critical materials are mostly a limitation for PEM. The anode side is subject to a high potential for oxidising (> 1.4 V) and not many materials can provide long-term operation under these conditions. Because of this, iridium – a scarce material – is used and the PTL requires significant amounts of titaniumbased (*i.e.* expensive) materials, coated with platinum. Although other options are available, platinum is used for the cathode, although tantalum seems to be a promising alternative for the coating. Titanium components are also responsible for the high costs of PEM, but this is mostly related to the expense of manufacturing titanium components, and less related to the raw cost of titanium.

Alkaline electrolyzers mostly use nickel to resist the highly caustic environment. Some designs derived from the chlor-alkali industry include platinum and cobalt. For alkaline water electrolysis designs optimised for green hydrogen production, however, we have commercial examples available today that do not use these materials. Platinum and iridium, used in PEM, are two of the scarcest, most energy-intensive and emission-intensive metals (see Figure 23).

Figure 23. Global warming potential and cumulative energy demand for critical materials used in electrolyzers.

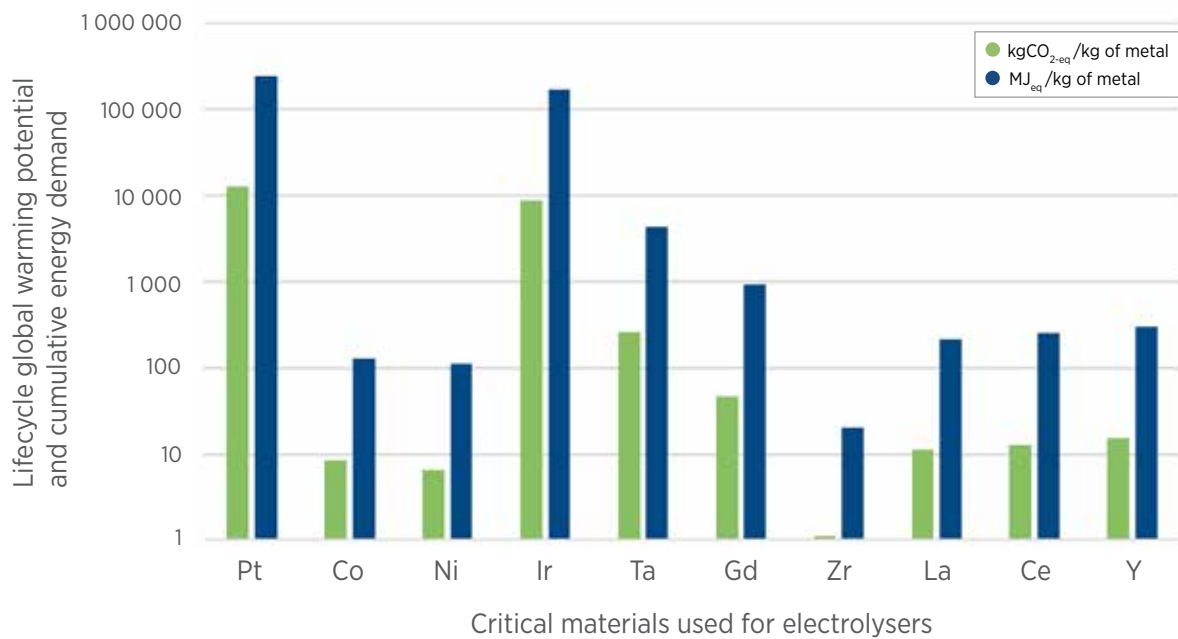

Source: Nuss and Matthew, 2014.

Platinum use is currently about 1g/kW (FCH JU, 2019). At the same time, primary platinum production is in the order of 200 tonnes per year (t/year)¹⁸ with about 20% more coming from the recycling of catalytic reformers in cars and electronic equipment. Two factors that further increase this number are the potential recycling of the platinum used by the industry and the expected decrease in platinum content, over time. These two factors are discussed further below. In the hypothetical case of using the entire production of platinum for electrolyzers, this would support the deployment of 200 GW per year (GW/year). Considering a lifetime of at least ten years and full recycling of platinum from decommissioned stacks, this pace of deployment would support the deployment of 2 000 GW in the next decade and 4 000 GW by the 2030s. Combined with the planned reduction of platinum requirements in PEM electrolyzers, this will further reduce the risk of material supply bottlenecks.

To avoid becoming a barrier to large-scale deployment, all the alkaline designs need to transition to platinum and cobalt free designs and platinum and iridium in PEM needs to be significantly reduced

Iridium use is currently about 1-2.5 g/kW. Global iridium production is about 7-7.5 t/year (Garside, 2019), which would support the deployment of 3-7.5 GW/year or 30-75 GW of electrolyser capacity in the next decade, reflecting the criticality of reducing iridium content rapidly and significantly.

Additionally, platinum and iridium are two of the most carbon and energy intensive materials in the electrolyzers (see Figure 23). Platinum production emits about 12.5 tonnes of carbon dioxide (tCO_{2-eq}) per kilo of metal. This translates into about 0.01 kg CO_{2-eq}/kg H₂¹⁹, which is relatively small compared to the electricity input (only 10 grammes of CO_{2-eq}/kWh would be equivalent to 0.5 kg CO_{2-eq}/kg H₂). Similarly, platinum production is the most energy intensive among the critical materials in electrolyzers with 243 gigajoules per kilo (GJ/kg). Given the high energy consumption of the electrolyser, however, the share of total electricity consumption in the system taken by producing these metals upstream is less than 0.01%. The supply of critical materials in electrolyzers is mostly dominated by a few countries (see Figure 24). South Africa supplies over 70% of global platinum and over 85% of global iridium. This would strongly link PEM electrolyser deployment to supply from a few (mainly one) countries, with limited short-term alternatives in sight for replacing these materials for PEM.

Solid oxide electrolyzers, which have the potential for much higher efficiencies, would also suffer from a similar risk, since almost 95% of the supply for all their critical materials (see Figure 24) currently comes almost exclusively from China.

Alkaline electrolyzers do use some platinum and cobalt, but there are already commercial designs that do not include these materials and the supply of nickel is more diversified when compared to the other metals.

The same applies to AEM, which does not use scarce materials and mostly requires steel and nickel.

¹⁸ Some 40% of this is used for catalytic converters in cars, so could eventually be available for other uses, as combustion engines are phased out.

¹⁹ Assuming a 10-year lifetime, a 50% capacity factor and platinum loading of 1 g/kW.

Figure 24. Top producers of critical materials in electrolyzers.

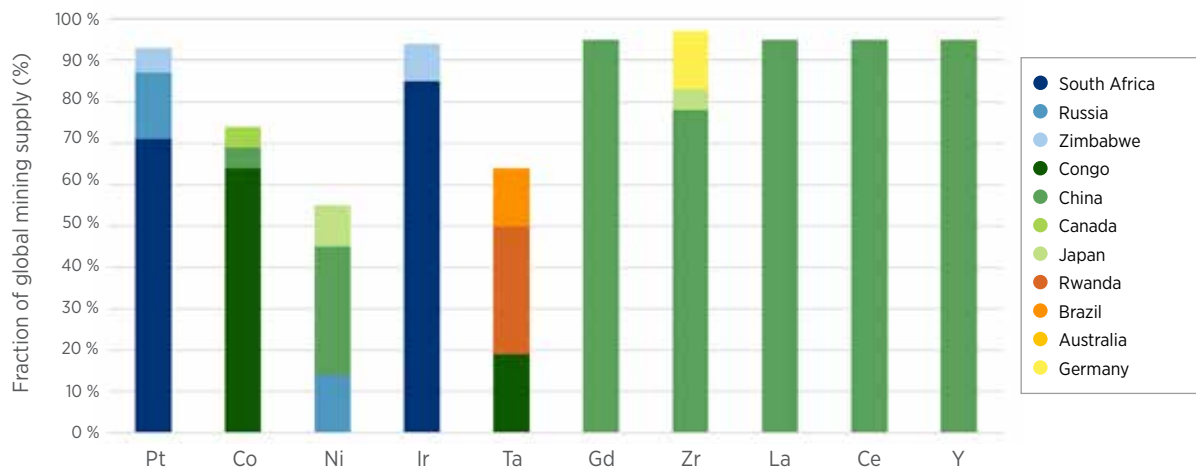

Source: European Commission, 2020.

In terms of cost, the market for iridium is relatively small (7-7.5 t/year), illiquid and subject to high price volatility (European Commission, 2020). The ratio between the highest and lowest price over the last 20 years is approximately 15 times. The highest price was in 2019, with USD 1480 per troy ounce, which is equivalent to about USD 46/kW (considering an iridium content of 1g/kW). Furthermore, in the 2016-2018 period, the market was undersupplied (European Commission, 2020), which created an upward pressure on price, with this potentially boosted further by a step demand increase coming from electrolyzers. For platinum, the market is larger than iridium, but the price volatility is still high, with a ratio of five times between the highest and lowest price over the last 20 years. The peak price in that period was just before the 2008 financial crisis, when it was USD 2000 per troy ounce, which would be equivalent to almost USD 60/kW (with an iridium content of 1 g/kW), while more recently the price has stayed in the USD 800-1000 per troy ounce range.

There are **three main strategies** to reduce dependence on critical materials (Van Berkel et al., 2020):

- Prevention or reduction of use: This covers substitution of the materials, reducing their amount per unit of installed capacity, or varying the technology mix to achieve a lower use overall (e.g. more alkaline instead of PEM that uses iridium). There are various options being investigated:
 - Use of high surface area supported catalysts – for example, titanium or tin oxide supports (Babic, 2017).
 - Increase the catalyst surface area through improved catalyst manufacturing techniques, for example using nanostructured thin film catalysts.
 - Use a thinner layer of coating material, for example through atomic layer deposition.
 - Reengineer the electrode concept. For example, support nanoparticles of iridium on high conductive semi-conductor oxides, alloy iridium to other transition metals, change the morphology of the electrode and shape the nanoparticle of iridium.

- **Extension of the use of equipment, or increasing its efficiency:** This includes achieving a higher productivity of the stack, which translates into a smaller area (and less material per kilo of hydrogen) or extend the lifetime of the electrolyser (*i.e.* the same amount of material allocated over greater production).
- **Recycling:** There are various methods available for recovering noble metals from electrochemical devices such as fuel cells and electrolysers. These include: hydrometallurgical treatment, transient dissolution, acid process and selective electrochemical dissolution. All of these can be used for platinum in PEM. Further research is needed to estimate the potential benefit of recycling, which could have an impact on large-scale applications. It could also have an impact in creating a parallel recycling industry to recover these materials and would be fundamental in preventing potential materials bottlenecks, as we rapidly scale-up manufacturing.

Reducing platinum use is not only beneficial from the perspective of scaling up electrolysers and reducing reliance on critical materials, but also from the perspective of reducing environmental impact. Platinum production dominates in

almost all environmental impact categories (*e.g.* acidification, eutrophication, photochemical oxidation) and its lower use will also result in lower overall impact (Duclos *et al.*, 2017).

Implementing these strategies, in combination with the improved electrolyser performance, can ultimately reduce the specific iridium content by 96% and the platinum content by 97.5% (see Table 7). Parallel to this development, the electrode area is expected to increase almost fourfold and the current density by 2.5 times. This means the loading per unit of capacity will not decrease as drastically, but it can still achieve reductions of 70% and 80%, respectively, for iridium and platinum. The electrolyser will also be developed in terms of delivering higher current densities (higher hydrogen production) for the same stack unit, which consequently means less catalyst needed per unit produced.

This is an area where the role for innovation will be increasingly important. Large players from the tech scene are getting involved in the context of leveraging their expertise to fight climate change. For instance, Facebook recently started a project focused on using artificial intelligence to find new catalysts to improve the transformation of renewable electricity into hydrogen (Wong, 2020).

Table 7. Iridium and platinum loading for PEM electrolysers with increased performance and material reduction strategies.

	TODAY	FUTURE
Current density (A/cm ²)	2	5
Electrode area (cm ²)	1200	5 000
Iridium loading (mg/cm ²)	5	0.2
Iridium loading (g/kW)	1.3	0.4
Platinum loading (mg/cm ²)	2	0.05
Platinum loading (g/kW)	0.5	0.1

Based on IRENA analysis.

3.4 INCREASING MODULE SIZE

The largest cost share is the balance of plant and not the stack itself (see Chapter 2, Section 6). Increasing the module size can lead to some benefits in economies of scale, with these greater for the balance of plant. The stack has limited economies of scale since it cannot be greatly increased in size, but will most likely be increased in number. This is due to problems that include, for example, leakage, limitations in the manufacturing of large-scale components, mechanical instability issues for large-scale components, the maximum

area of the cell, and others. The balance of plant, however, can have strong economies of scale. For instance, a compressor that is ten times larger (e.g. going from 1MW to 10 MW) is not ten times more expensive, but only about four times. This would reduce the cost that such a compressor has on the overall cost, since the stack would be 9-10 times more expensive for the same capacity increase. This leads to the stack having a larger contribution to the total cost, as module size increases (see Figure 25).

Figure 25. Cost breakdown by major component for alkaline electrolyzers based on current costs.

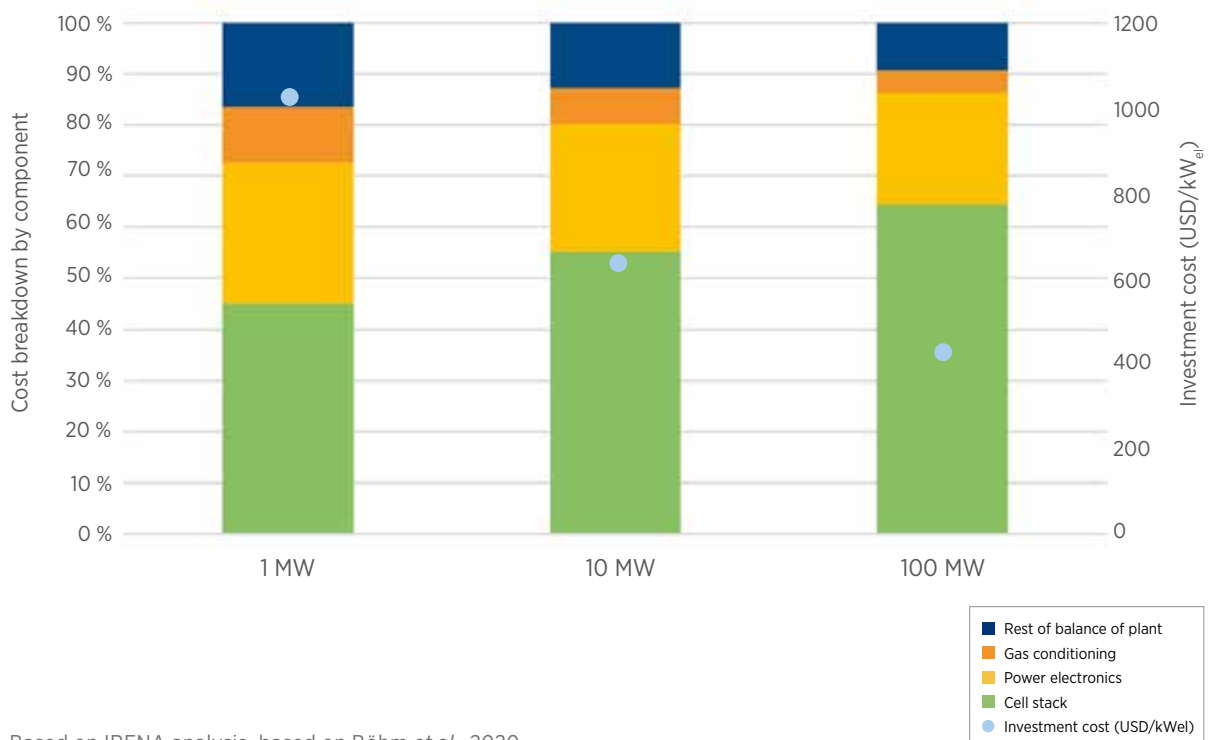

Based on IRENA analysis, based on Böhm *et al.*, 2020.

Some studies have looked into the potential cost decrease for increasing the module size and reaping these economies of scale (Saba *et al.*, 2018; Böhm *et al.*, 2020; Proost, 2020) a literature review was conducted to evaluate the published data on investment costs and learning rates for PEM and alkaline electrolyzers from the 1990s until 2017 and the years beyond. The collected data are adjusted for inflation and specified in €2017 per kW-output using the higher heating value (HHV). Böhm *et al.* estimates the cost exponent to be 0.60.75 for the balance of plant (Böhm *et al.*, 2020). This would lead to a cost increase of 4-5.6 times when

increasing the capacity by ten times. Saba *et al.* use data from NEL (one of the main electrolyser manufacturing companies) and also include the cost penalty for increasing the operating pressure (Saba *et al.*, 2018). Proost identifies 3-4 MW module size as a tipping point to go from a single stack to a multi-stack and achieve a significant change in the cost increase for every additional MW of capacity (Proost, 2020). This is highly dependent on stack design, however, and will vary from one manufacturer to another. Figure 26 shows a comparison between the estimates of these studies plus the use of the cost shares in Section 3.6 and

the cost exponents from Böhm et al (Böhm et al., 2020). The largest economies of scale are reaped around the 1020 MW module size. Beyond this point, the marginal cost decrease for increasing the capacity is much lower than for module sizes in the 12 MW range. The “PlanDelyKad” study in Germany performed a bottom-up design and cost assessment finding close to 50% cost reduction for a 100 MW alkaline electrolyser (EUR₂₀₁₄ 520/kW_{input}) vs a 5 MW electrolyser (EUR₂₀₁₄ 1070/kW_{input}) (Noack et al., 2015). One of the manufacturers, Thyssenkrupp, claims significant cost benefits can still be achieved by going to 100 MW.

Today, the largest electrolyser installed is a 10 MW facility in Fukushima, Japan, which is a single stack (FCW, 2020). Thyssenkrupp and NEL already offer designs up to 20 MW, achieved with multiple stacks (thyssenkrupp, 2018; Nel, 2019) without degradation in the efficiency or response capability of the electrolyser. The largest module from McPhy is 4 MW (McPhy, 2020), while the Sylizer 300 from Siemens is designed for 17.5 MW, constituted by 24 modules (of less than 1 MW each) (Bergen, 2019). Cummins (Hydrogenics) is building a 20 MW PEM

water electrolyser in Becancour-Canada, based on stack platforms of 2.5 MW. The plant is expected to be operational before the end of 2020.

Another approach applied by some AEM manufactures is a strategy that focuses on design, achieving cost reduction by mass-manufacturing, standardisation, and supply efforts on a single stack offering. Larger capacities are achieved by using multiple stacks of this single size. Advantages include: the different flexibility response (*i.e.* a set of smaller electrolysers can react more quickly than a single, large stack); a reduction in the impact of failure by a single unit; and a higher utilisation of the manufacturing equipment.

Figure 26. Electrolyser investment cost as a function of module size for various technologies.

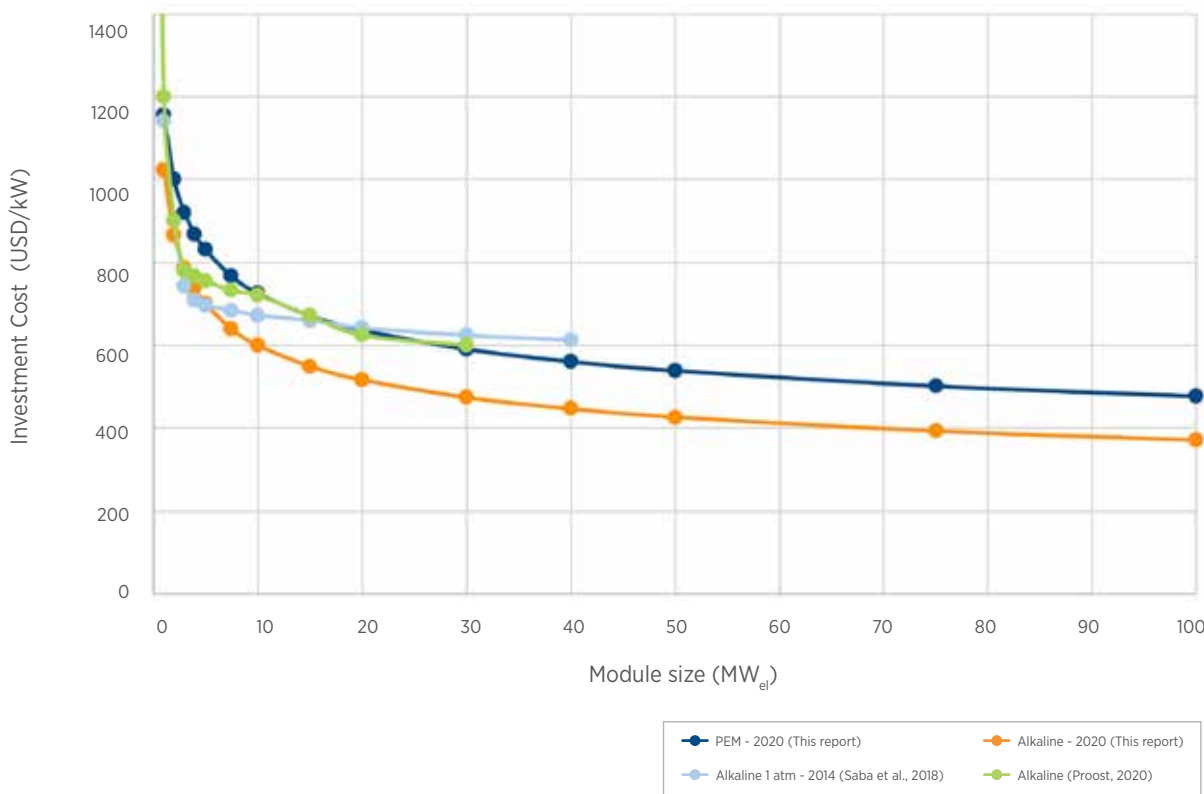

Source: Saba et al., 2018; Proost, 2020.

4.

STRATEGIES FOR COST REDUCTION: SYSTEM LEVEL

KEY POINTS

- The largest benefits for economies of scale for electrolyser manufacturing seem to be reached around the 1GW/year level. Several industrial players claim to have reached this scale or are working towards expansion. One measure governments could take is to set manufacturing capacity targets, manufacturing tax benefits, grants and loans for capacity expansion and work in close collaboration with industry. The Netherlands and the UK are examples of where this is happening. A predictable 5-10 year pipeline of electrolysis projects – driven by green hydrogen demand – will be key for manufacturers to invest in new, larger and automated production facilities. Uncertainties about the demand for green hydrogen versus fossil-fuels based hydrogen is a key obstacle to the scaling up of electrolyser manufacturing: policy makers should carefully assess the balance, as learning from investments in green hydrogen versus blue hydrogen production are not interchangeable.
- Water electrolysis deployment for green hydrogen has been limited so far, which introduces uncertainty around the cost reduction that can be achieved by scaling up. From this limited experience, it seems electrolysers have a similar relationship between cost decrease and global capacity as solar PV does – which could lead to 40% cost reduction, given the capacity targets governments have already announced. One action governments could take is to ensure cost is communicated transparently, in order to be able to track progress and identify potential.
- Cost decrease is greatest during the current early stage of deployment, when cumulative capacity deployed is still small and the market is relatively concentrated in a few companies. Current costs suffer from lack of transparency, due to the nascent stage of the industry, which will likely be resolved as large-scale manufacturing facilities come online and large projects get commissioned. This, in turn, will facilitate price discovery and improve cost reduction forecasts.

Looking beyond the stack to include the balance of plant, there are two main strategies to reduce the cost:

- Increasing the **manufacturing scale** of the plant. This allows reducing the cost contribution of each component by performing a high throughput, automated manufacturing operation. This includes, for example, rolltoroll manufacturing of the catalystcoated membrane (for PEM) and advanced coating processes for metal plates (Mayyas et al., 2019).

- **Learning-by-doing.** This relates to standardisation, applying lessons learned from deployment and optimising the installation of equipment through the execution of multiple projects.

These two effects are not independent, since increasing the global cumulative deployment is expected to be linked to an increase in global manufacturing capacity. Nevertheless, applying both concepts separately allows us to draw different insights into the drivers of lower production costs.

4.1 MANUFACTURING SCALE OF ELECTROLYSERS

Increasing the manufacturing scale of the electrolyser plants can have a positive impact on their specific cost. Large manufacturing volumes can decrease the cost contribution of buildings, improve the utilisation of equipment (*i.e.* increasing the volume produced from each unit and reducing the cost contribution) and improve the process yield (reducing losses). Furthermore, for low volumes, manual assembly might be necessary, while higher volumes make automatic assembly

attractive. These economies of scale during manufacturing have been assessed in the past for PEM (NREL, 2019). Figure 27 shows the system cost for producing 1-MW units. Two aspects to note are: the annual production rate where most of the cost benefits have been achieved; the cost categories that do not change significantly with the production rate and dominate the cost, even at high volumes.

Figure 27. Cost breakdown for PEM electrolyzers as a function of manufacturing scale (units of 1 MW per year).

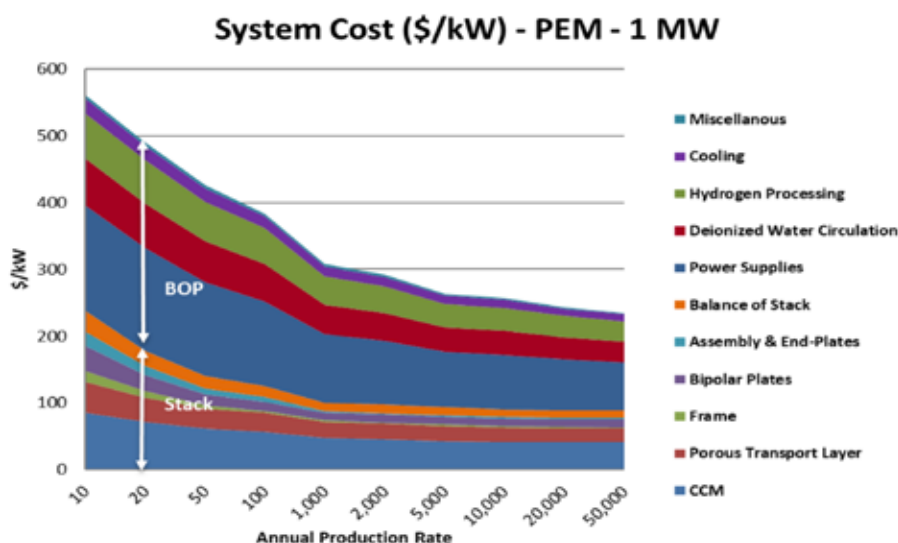

Note: Costs include material, labour, capital, energy, maintenance, buildings and scrap costs.

Source: Mayyas et al., 2019.

Focusing on the stack first, Table 8 shows that the point where most of the components are dominated by the costs of material (and labour in the case of the assembly) is about 1 000 units per year (*i.e.* 1 GW/year). Going from a 10 MW/year scale to 1 GW/year allows a 70% reduction in the stack cost, to about USD 70-80/kW. The largest benefit is for the stack assembly, which can experience a 90% cost reduction by going from a manual to a semi-automated assembly at a volume of about 1 GW/year, with a subsequent change to fully automated at 2 GW/year. This automation needs to happen at two levels: the cell and the stack, to have the highest cost impact. The cost saving is not only from automation of the process, but also from using advanced coating technologies, such as roll-to-roll and replacing

current processes, such as spray coating. This allows for a faster, higher throughput process capable of producing thicker uniform catalyst layers (Mayyas and Mann, 2019) material handling equipment (MHE). Frame manufacturing achieves a similar (85%-90%) cost reduction at the same scale (*i.e.* 1 GW/year). The cost reduction for components that contain rare materials is less pronounced, with the CCM and PTL only being able to achieve between 45%-55% cost reduction at the 1 GW/year scale. This results in stack cost being dominated by the platinum, iridium,²⁰ membrane, titanium and gold costs, for large production volumes. Further cost reductions can only be achieved through the material reduction strategies presented in Section 4.3 of this report.

Table 8. Economies of scale for PEM stack manufacturing.

Stack component	Capacity to reap most of the economies of scale	Dominant costs at high production rates	Cost penalty for low production volumes	Cost achieved at 1 000 units/year
Catalyst coated membrane	1 000 units/year	Platinum, iridium, (Nafion) membrane	75%-80%	≈ USD 46/kW
Porous transport layer	20-100 units/year	Titanium powder, gold (coating material)	110%	≈ USD 26/kW
Frame	1 000 units/year	Materials (95%)	800%-900%	≈ USD 1.8/kW
Membrane Electrode Assembly	1 000 units ¹ /year	Materials (90%)	350%	≈ USD 11/kW
Assembly	1 000 units/year	Labour (50%)	1 000%	≈ USD 2/kW

Source: Mayyas *et al.*, 2019.

20 r(NREL, 2019) reflects assumptions of 7 g/m² for platinum loading in the anode, 4 g/m² for the anode (platinum-iridium), a platinum price of USD 1 500 per troy ounce, a Nafion 117 (membrane) and titanium plates coated with 100 nanometres (nm) of gold.

21 One unit requires about 50 MEA, assuming a 1 MW system, so 1 000 units is equivalent to 500 000 MEA/year, which is assumed to trigger the shift from manual to semi-automated assembly.

For the balance of plant, however, the cost reduction is smaller than for the stack. The same increase in production rate, from 10 MW/year to 1 GW/year, leads to a cost reduction of about 40% in the balance of plant. This means the balance of plant goes from about 55% of the total cost to almost 75% on a 1 GW/year scale (see Figure 28).

The largest cost reductions – of 50%-60% – can be achieved in the deionized water circulation and the cooling systems. These, however, are relatively small and the dominant costs of the power supply and hydrogen processing only reduce by about 30%.

Figure 28. Cost breakdown for PEM electrolyzers for a (a) 10 MW/year; (b) 1 GW/year production scale.

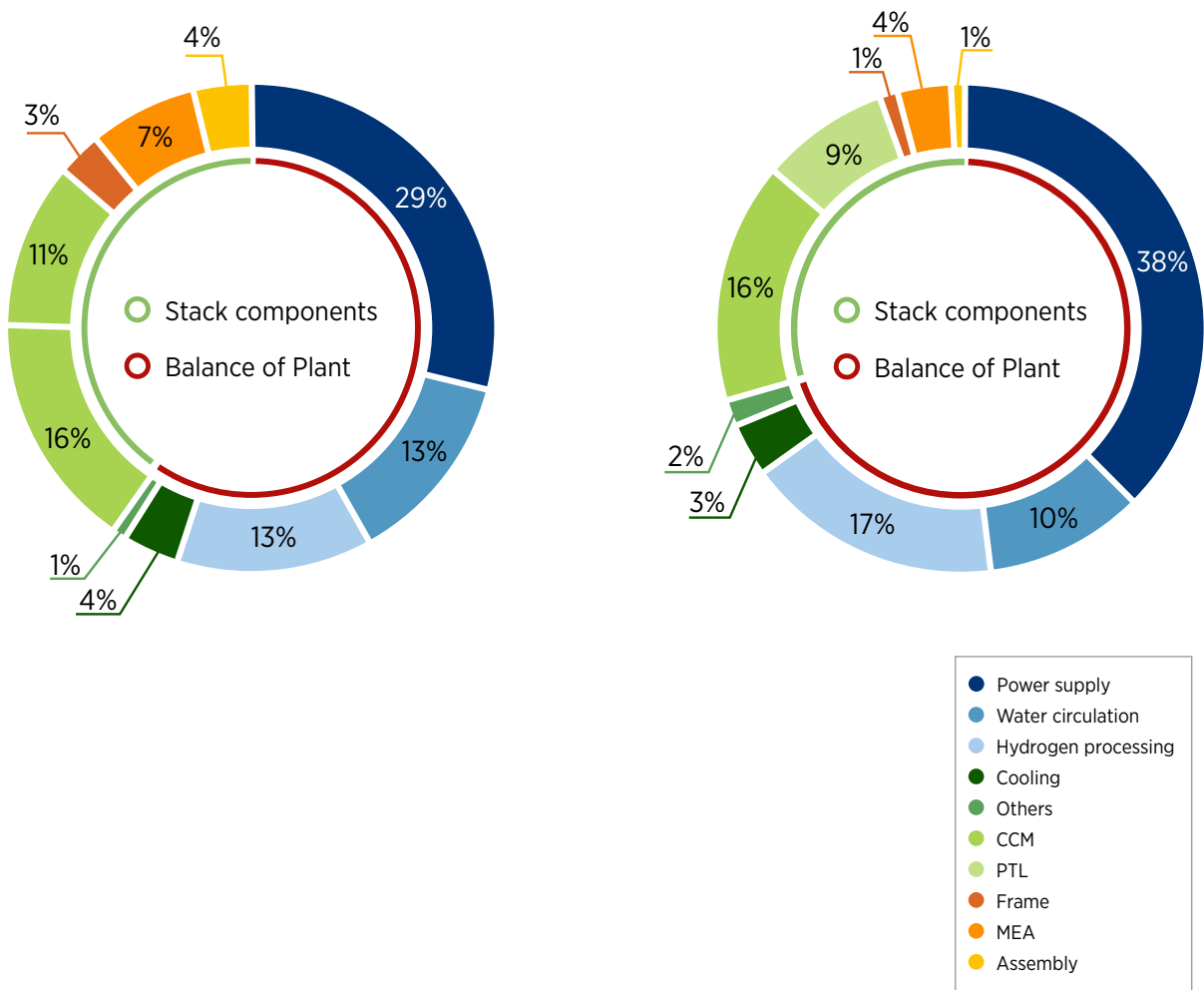

Based on IRENA analysis based on Mayyas et al., 2019.

Two years ago, the electrolyser market was about 135 MW/year, with the largest manufacturers in the order of 10-20 MW/yr. As shown in the figures above, this is where the cost contribution of fixed costs is the largest. Today, various estimates and announcements point towards a higher manufacturing capacity. The World Bank estimates the capacity to be 2.1 GW/year with announcements on capacity expansion adding up to 4.5 GW/year (World Bank, 2020). The IEA estimates a capacity of 1.2 GW/year just in Europe. Looking at claims and announcements from manufacturers:

- Thyssenkrupp has a manufacturing capacity of 1 GW/year that could be expanded.
- NEL is expanding the capacity of their facility at Herøya Industrial Park (Norway) from 40 MW/year to 360 MW/year, with future expansion plans of up to 1 GW/year.
- ITM is part of the Gigastack project, that aims to ramp up production capacity to 60 stacks per year (300 MW/year) by 2023 and 200 stacks (1 GW/year) by 2025. This is to be done with a simultaneous increase in the system size to 20 MW to achieve a specific investment cost of GBP 400/kW with a module size of 100 MW. The ramping up is 60 stacks per year (300 MW/year) by

2023 and 200 stacks (1 GW/year) by 2025. The project is currently in the frontend engineering and design (FEED) phase (Phase II), with the design of the 100 MW facility, which is 5x20 MW, with this expected to be completed by the end of 2020.

A scale of 1 GW/year for the manufacturing plant might be enough to achieve economies of scale during production. Some manufacturers already claim to be at this scale or with plans to achieve such a production level

- While Siemens does not have an explicit manufacturing target, it is also involved in various 100 MW+ projects around the globe, putting them in a good position to expand capacity. One of these projects is the Murchison Renewable Hydrogen Project in Australia, which has scope for up to 5 GW of renewable capacity and is initially expected to produce hydrogen for transport fuels, followed by blending with natural gas and exports.

4.2 LEARNING-BY-DOING

The experience curve or learning curve²² refers to the decline in production cost as the cumulative capacity for a specific technology doubles. This represents innovation by production and is driven by competition between firms in the market that complements innovation driven by research. There are multiple ways this cost decrease can be achieved. For example, a lower contribution from fixed costs, a reduction in the production time, standardisation, specialised companies for certain parts of the value chain, and alternative processing steps, including simplification.

Larger cumulative deployment not only leads to more experience from project developers, but also financial institutions. This can in turn lead to lower risk perception, lower the cost of debt and further cost reduction.

Water electrolysis shares the same principles as chlor-alkali production (which already produces hydrogen today). This means, for learning purposes, the starting point for water electrolysis is not the 0.2 GW of PtX existing today, but instead the cumulative 20 GW of electrolyser capacity that

²² In a more nuanced differentiation, the learning curve refers to the relationships between cumulative capacity and lower production time, while the experience curve relates capacity to cost (Böhm, 2019).

has been deployed for chlor-alkali. Similarly, the learning rate for electrolysis can build upon existing studies that look at fuel cells, since these are the same fundamental process, but in the reverse direction²³. Fuel cells and electrolyzers can benefit from developments in batteries (IEA, 2020), since they also use the same principle and share the same component families (anodes, cathodes, membranes and assemblies). This would allow electrolyzers to indirectly benefit from battery electric vehicle (BEV) and fuel cell deployment across the various transport modes and even on large-scale stationary use. These cumulative cost reductions can be captured in a learning rate.

Table 9 shows a survey of the studies that have estimated learning rates for electrolyzers and fuel cells, with data going back over 60 years in some cases. Most of the studies find a learning rate of 16%-21%, with several having the mid estimate at 18%. One of the studies (Wei, Sarah Josephine Smith and Sohn, 2017), which focuses on smallscale fuel cell applications in California, does not, however,

demonstrate any learning throughout the period analysed (2007-2015).

Electrolyzers have similar learning rates to solar PV and could experience similar cost decreases with large-scale deployment. This learning opportunity might decrease over time as deployment takes place

Reasons for the lack of learning in that study included the lack of a competitive market, lack of favourable market conditions and lack of government targets for technology adoption. This shows the importance of public support for both deployment and learning. Considering the mid-estimate of 18% and the 20 GW of existing capacity, the potential cost decrease from deployment is shown in Figure 29.

Table 9. Learning rate estimates for electrolyzers and fuel cells.

Learning rate (%)		Notes	Reference
9	Electrolysis	Alkaline for 2020-2030	(Hydrogen Council, 2020)
13	Electrolysis	PEM for 2020-2030	(Hydrogen Council, 2020)
18 +/- 6	Electrolysis	1956-2014 data (alkaline)	(Schmidt <i>et al.</i> , 2017)
18 +/- 13	Electrolysis	1972-2004 data	(Schoots <i>et al.</i> , 2008)
8	Electrolysis	Floor cost of USD 350/kW (alkaline)	(Gül <i>et al.</i> , 2009)
18 +/- 2	PEM fuel cell	1989-2012 data	(Schmidt <i>et al.</i> , 2017)
18	PEM fuel cell	Initial capacity of 1.1 GW	(McDowall, 2012)
15	PEM fuel cell	Based on proprietary data	(McKinsey, 2010)
21 +/- 3	PEM fuel cell	1996-2006 data	(Schoots, Kramer and van der Zwaan, 2010)
15	PEM fuel cell	Floor cost of USD 50/kW	(Gül <i>et al.</i> , 2009)
0%	Solid oxide fuel cell	California self-generation incentive programme	(Wei, Sarah Josephine Smith and Sohn, 2017)
16 +/- 3	µCHP	Based on EneFarm, Korean demonstration and PEMFC manufacturer	(Staffell and Green, 2013)
18 +/- 2	µCHP	Based on EneFarm	(Wei, Sarah J. Smith and Sohn, 2017)

Source: See "Reference" column.

Figure 29. Potential cost decrease for electrolyzers based on a learning rate and costs achieved by deployment in IRENA scenarios by 2030 and 2050.

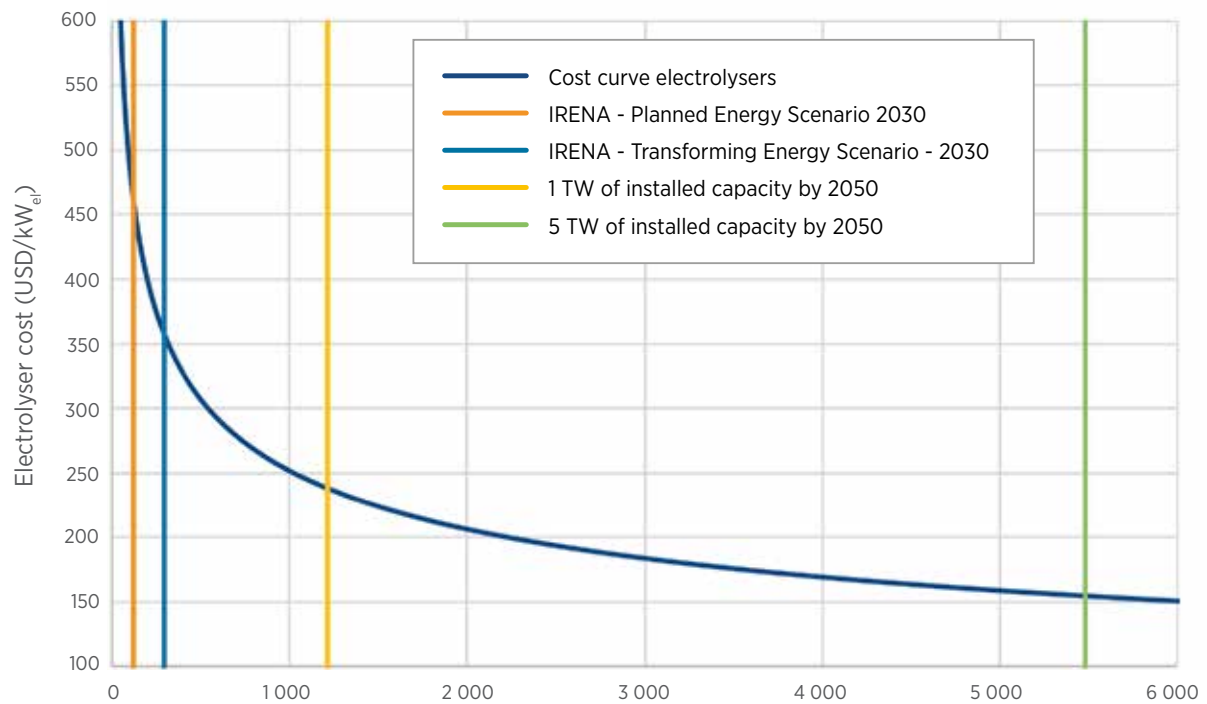

Notes: 1 TW of installed capacity by 2050 is about 1.2 TW of cumulative capacity due to lifetime and replacement. Similarly, 5 TW by 2050 is equivalent to 5.48 TW of cumulative capacity deployed.

Based on IRENA analysis.

In the Planned Energy Scenario from IRENA, electrolyzers could achieve about 40% cost reduction by 2030 with 100 GW of capacity deployed. In the case of the Transforming Energy Scenario that requires a more aggressive deployment of 270 GW of electrolyzers by 2030, an almost 55% cost reduction is achieved. In the long term, looking at a closetozero emissions system, where 1700 GW of electrolysis is deployed by 2050, the cost reduction can be over 70%. This is not dramatically different from the Hydrogen Council estimate of a cost reduction of 60% by 2030 through a combination of manufacturing scale, learning rate, technological improvements and increase in the module size from 2 MW to 90 MW (Hydrogen Council, 2020).

Similar to the economies of scale for manufacturing, where components reduce their cost unevenly with scale, the potential for learning is also different by component. A recent report (Böhm, Goers and Zauner, 2019) looked into the learning rate by component for alkaline, PEM and solid oxide electrolyzers (see Table 10). For this, components are assigned one of three learning rates: 5% for technologyindependent standard parts (e.g. flanges); 8% for peripheral parts that are technology specific (e.g. catalysts); and 18% for the core components of the electrolyser.

Table 10. Learning rate by stack component for three types of electrolyzers.

TECHNOLOGY	COMPONENT	LEARNING RATE (%)
Alkaline	Structural rings	5%
	Polytetrafluoroethylene seal	8%
	Bipolar plates	18%
	(Pre)electrodes	18%
	Membrane	18%
	Flanges	5%
	Tie rods	5%
PEM	Stack assembling	8%
	Small parts	5%
	MEA manufacturing	8%
	Catalysts	8%
	Membranes	18%
	Current collectors	18%
	Bipolar plates	18%
	End plates	8%
Solid oxide	Stack assembling	8%
	Electrolyte	18%
	Catalysts	18%
	Porous transport layer	18%
	Interconnector	18%
	Sealings	5%
	End and pressure plates	8%
Balance of plant	Power supply	12%
	Gas conditioning	7%
	Small purchased parts	12-15%
	Machining	10%
	Welding	10%

Source: Böhm, Goers and Zauner, 2019.

Components that have a high learning rate will represent a smaller share of the overall cost as capacity increases, since their cost decrease is larger than components with a low rate. This means the overall learning rate goes towards the

lower values with larger capacities (see Figure 30). This approach indicates that using a fixed value for the learning rate can result in an overestimation of the potential cost decrease.

Figure 30. Variable learning rate based on components for three types of electrolyzers.

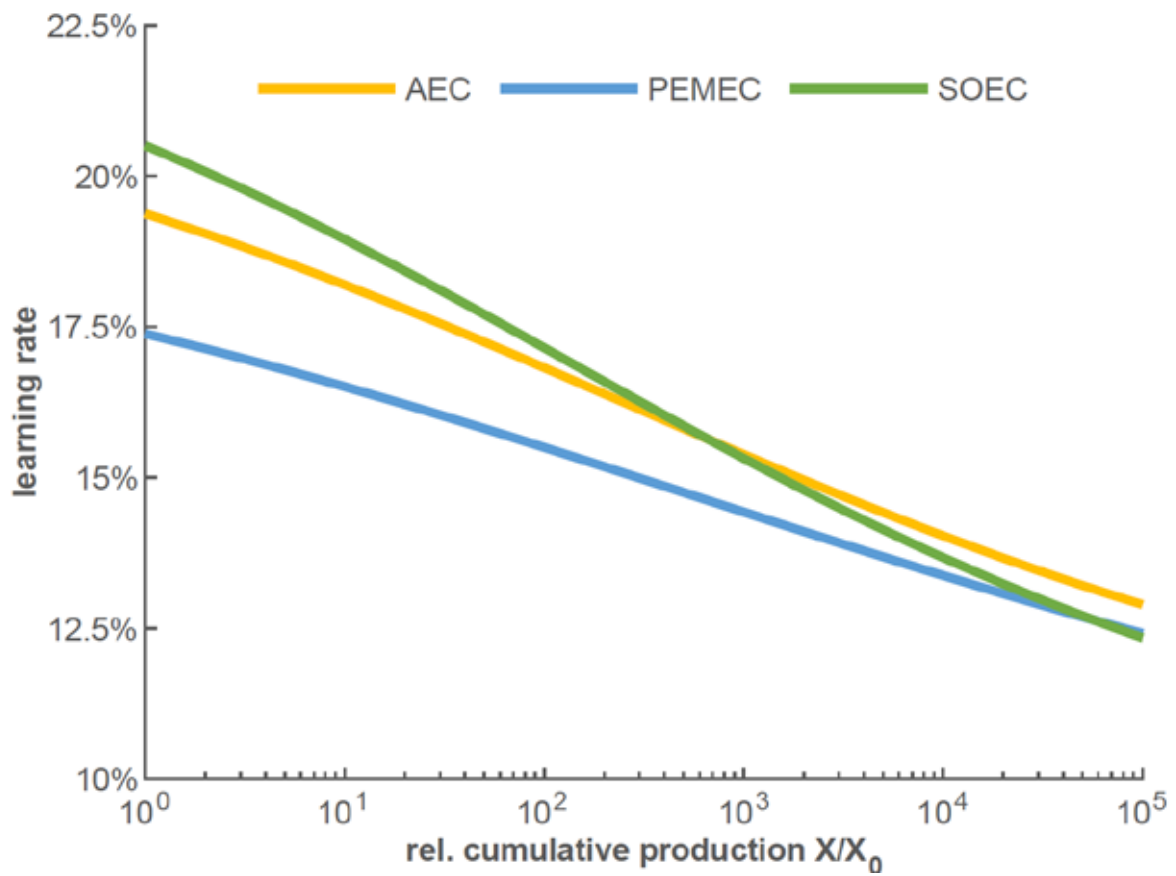

Source: Böhm, Goers and Zauner, 2019.

5.

GREEN HYDROGEN PROJECT PIPELINE

KEY POINTS

- Announcements of projects coming online in the next five years add up to a total that is two orders of magnitude greater than today's globally installed capacity. Yet, even steeper growth would be needed to be in line with 1.5°C pathways. This requires a further acceleration in the deployment of renewable power capacity, which needs to be at least ten times higher in 2050 than what it was in 2019. Therefore, hydrogen use should be limited to sectors where direct electrification is more difficult, to maximise the efficiency of renewable electricity use.

5.1 KEY PLAYERS

R&D institutions and industry will appear, increasing competition that leads to much faster R&D and a significant reduction in costs. Currently, the field of green hydrogen generation is growing at such a fast rate that is quite challenging to follow or identify new players. Historically, with a few exceptions, water electrolyzers were manufactured by small companies. Now, large enterprises are currently very active in acquiring and

merging small/medium sized electrolyser companies into their subsidiary portfolios. This will dramatically and positively increase investment, much more rapidly changing the technology and decreasing costs. Table 11 shows a non-exhaustive list of companies, enterprises and key players involved in the manufacturing and/or commercialisation of water electrolyzers.

Table 11. A nonexhaustive list of key players involved in the manufacturing of water electrolyser systems.

COMPANY	MANUFACTURING SITE	ELECTROLYSER TYPE
AQUAHYDREX	AUSTRALIA, USA	ALKALINE
ASAHI KASEI	JAPAN	ALKALINE
AREVAH ₂	FRANCE, GERMANY	PEM
CARBOTECH	GERMANY	PEM
COCKERILL JINGLI	CHINA	ALKALINE
CUMMINS - HYDROGENICS	BELGIUM, CANADA, GERMANY	PEM AND ALKALINE
DENORA	ITALY, JAPAN, USA	PEM AND ALKALINE
ENAPTER	ITALY	AEM
GINER ELX	USA	PEM
GREEN HYDROGEN SYSTEMS	DENMARK	ALKALINE
HALDOR TOPSOE	DENMARK	SOLID OXIDE
HITACHI ZOSEN	JAPAN	ALKALINE AND PEM
HONDA	JAPAN	PEM
HYDROGENPRO	NORWAY	ALKALINE
iGAS	GERMANY	PEM
ITM	UK	PEM
KOBELCO	JAPAN	ALKALINE AND PEM
KUMATEC	GERMANY	ALKALINE
MCPHY	FRANCE, ITALY, GERMANY	ALKALINE
NEL Hydrogen	DENMARK, NORWAY, USA	PEM AND ALKALINE
PERIC	CHINA	ALKALINE
PLUG POWER	USA	PEM
SHANGHAI ZHIZHEN	CHINA	ALKALINE
SIEMENS ENERGY	GERMANY	PEM
SOLIDpower	ITALY, SWITZERLAND, GERMANY, AUSTRALIA	SOLID OXIDE
SUNFIRE	GERMANY	SOLID OXIDE
TIANJIN	CHINA	ALKALINE
TELEDYNE	USA	PEM
THYSSENKRUPP UHDE	GERMANY	ALKALINE
TOSHIBA	JAPAN	SOLID OXIDE

Based on IRENA analysis.

5.2 PROJECT PIPELINE AND EXPECTED FUTURE MANUFACTURING CAPACITY

Figure 31. (a) Historical and (b) Future (based on announcements and projects) electrolyser capacity.

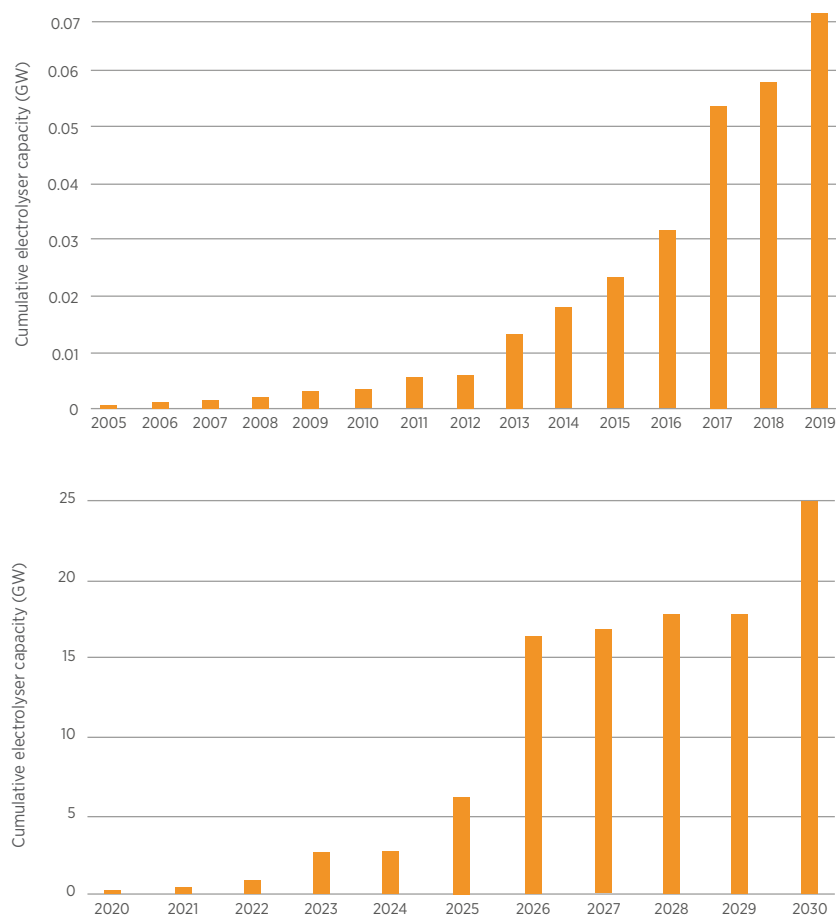

Note: Only water electrolysis included.

Source: IEA TCP

With such a challenging background in mind, powertogas demonstration projects of current generation using electrolysis technologies are important. The number of demonstration projects using electrolysers at scale has significantly increased and evolved in recent years (see Figure 31), and most of these for PEM and alkaline electrolysers. In addition, many demo projects have also tackled the hydrogentoefuels route, as a way of increasing the speed of hydrogen’s market penetration, especially for transportation purposes and other important markets. A consortium of seven private companies have also established a target of 25 GW of electrolysers capacity by 2026 aiming to reduce the cost to less than USD 2/kg. This coalition is called Green Hydrogen Catapult and it is part of the Race to Zero Campaign from the United Nations Framework Convention on Climate Change.

Increasing manufacturing capacity at pace is going to be equally important, to avoid bottlenecks in electrolyser supply. To reach an estimated 15 TW of installed capacity in 2050,²⁴ a rapid scale up of electrolysis capacity from an estimated 2 GW in 2020 to at least 10-60 GW/year by 2030 and 70-360 GW/year by 2040 – as estimated in Figure 32 – is required. This necessitates a rapid acceleration in the industrialisation of electrolyser manufacturing. This also has to happen together with development of the necessary, related EPC capacity to design, build and commission such facilities at an increasingly rapid pace. To reach net zero emissions by 2050, nothing less than the upper end of the range will be necessary.

Figure 32. Estimated necessary electrolyser manufacturing capacity (GW/year) to meet different installed capacity targets by 2050.

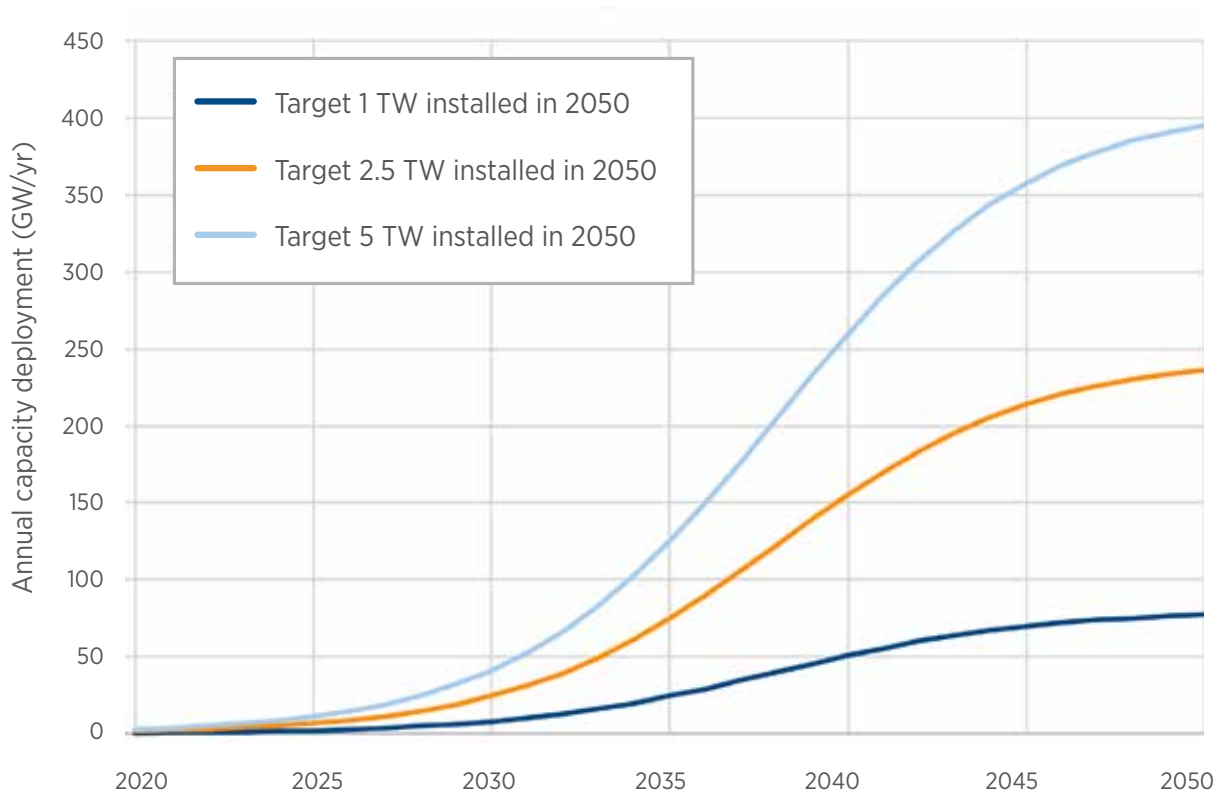

Based on IRENA analysis.

In terms of the investment necessary to scale up manufacturing capacity, a recent report (Cihlar et al., 2020) estimates a cost per GW of annual manufacturing capacity in the range of EUR 45-69 million, with the lower end for alkaline and the higher end for PEM. Combined with the estimated manufacturing capacity requirements in Figure 32, this translates into a cumulative

investment in manufacturing capacity of between USD 5-45 billion for the period 2020-2050, depending on the installed capacity target.

6.

THE ROAD TO SCALING UP GREEN HYDROGEN: A MILESTONE-DRIVEN APPROACH

KEY POINTS

- Progress towards a lower cost is not a time bound trajectory. The cost-reduction pathway will be defined by how quickly specific key milestones are achieved. This depends on governments setting time bound targets and measures to support green hydrogen demand, which in turn will promote scale up (explicitly or implicitly) and increased competition in electrolyser manufacturing and deployment.
- No single cost reduction strategy is recommended to be pursued, as the four strategies presented in this report should be considered in parallel. A combination of government support for research programmes in parallel with the establishment of policies and targets, combined with private sector efforts towards standardisation and optimised designs will lead to lower electrolyser costs and ultimately cheaper green hydrogen.
- A 40% cost decline could be achievable in the short term, with a final 80% cost reduction in the long term when all the targets are achieved.
- Investment cost is only one component of the total green hydrogen cost. To achieve cost competitiveness with fossil-based hydrogen, low electricity cost, favourable regulation, higher efficiency and a longer lifetime will be needed.

The strategies for cost reduction presented in this report are highly interrelated and pursuing only one might not even be possible. Furthermore, this is not a sudden process involving abrupt changes. Instead, it is gradual, with multiple reinforcing loops.

Larger manufacturing capacities are likely to be associated with the deployment of larger modules and will also favour more deployment, since production cannot be too far ahead of market demand. Therefore, to reach multi-GW production capacities, a multi-GW market also has to exist. There is a positive feedback, similar to any other

part of the energy system, where research leads to improvement in performance (durability, efficiency and cost), which makes the technology more competitive, triggering deployment (learning-by-doing), which enables lower cost, attractive private capital for R&D and further improvement.

In exploiting these synergies, different stages of development can be identified, where each strategy reinforces changes taking place in other parts of the value chain and all act in the same direction to drive the cost down. Figure 33 splits the period from where we are today to a future

with a low cost of investment in electrolyzers into three stages. Each is followed by a description of what should happen in every stage and every strategy to achieve long-term, low-cost hydrogen. Progressing from one stage to the next is not a timebound activity. Instead, how fast the end cost in Stage 3 is achieved will depend on how fast the milestones are reached. This will depend on policy support, capital invested and deployment.

Figure 33. Milestones for four cost reduction strategies across three stages of deployment for electrolyzers.

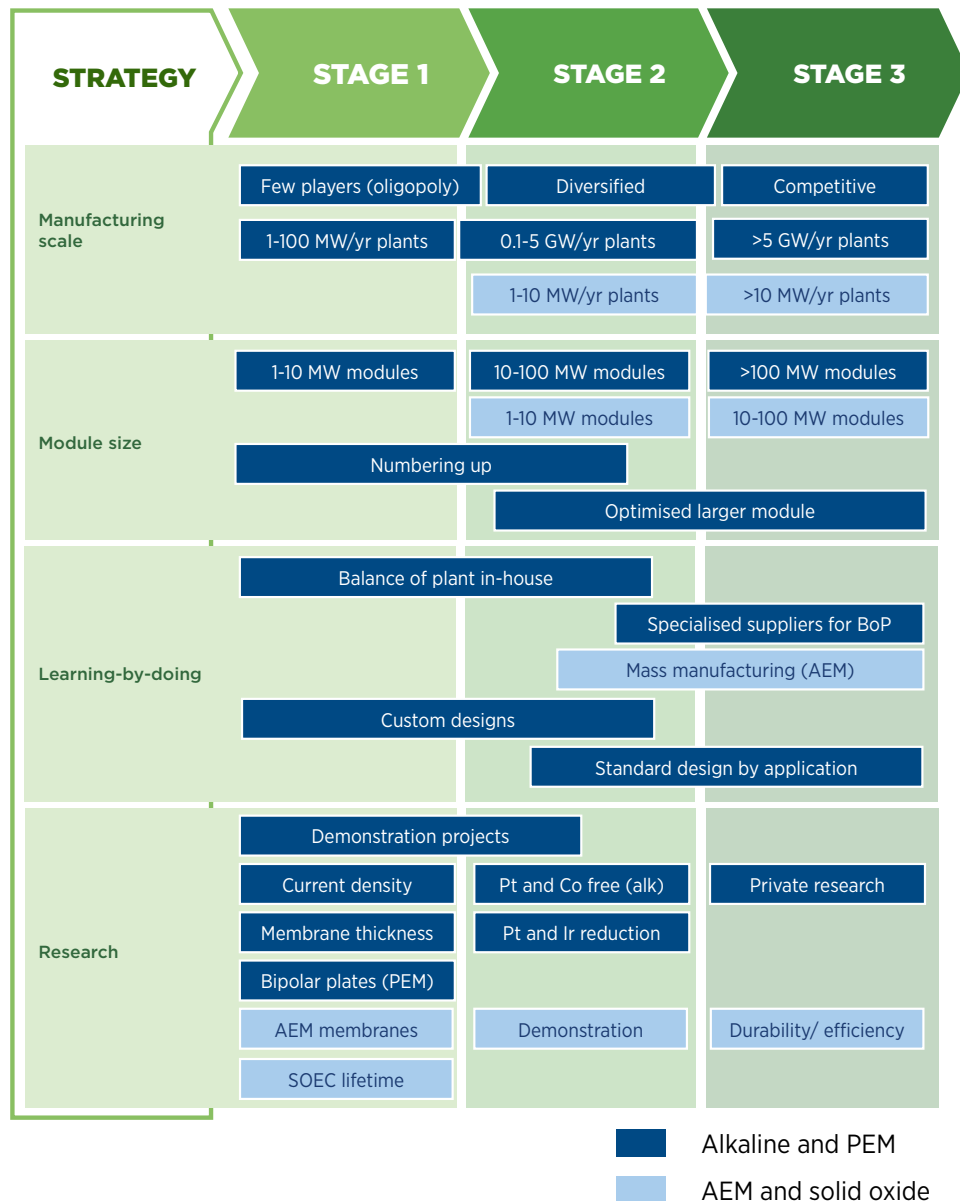

Based on IRENA analysis.

Stage 1: Market establishment

- **Manufacturing scale:** At this stage, the market is still concentrated in the hands of a few players. Most of them are in the MWscale, still using manual assembly and relying on individual projects to adjust production. Most manufacturers are in a stalemate situation where funding and investment is needed to expand capacity, but project capacities cannot be met with such a small manufacturing capacity. The leading manufacturers are starting to expand capacity in anticipation of future growth and starting to discover some of the economies of scale. Companies that produce chlor-alkali have a head start for water electrolysis, given that a large part of the supply chain can be used as a springboard.
- **Module size:** Modules are relatively small, with most of the options available in the market in the MWscale. Projects that target 10, 20, 30 MW are mostly numbering up smaller electrolysers and the balance of plant is not fully optimised. These small modules are ideal for onsite hydrogen generation in refuelling stations, which matches the relatively small requirements of transport applications, avoids infrastructure development and scales much better than fossilbased hydrogen production. Several manufacturers are starting to envision 100MW+ designs, but no experience of this creates a gap between engineering and reality to be closed in subsequent stages.
- **Learning-by-doing:** There is limited experience in water electrolysis and most of the lessons are drawn from chlor-alkali. Water electrolysis is being deployed in multiple new applications by multiple manufacturers, which creates custom designs that need to be adjusted before being used in another system. These demonstration and firstofakind plants still have a large cost associated to engineering and installation – and potentially with planning and execution delays. On the positive side, the learning rates are the highest at this stage, since there are multiple opportunities for optimisation.

- **R&D:** Research done at this stage has the highest benefits, since the technology is at the earliest stage of development. The areas to focus on for alkaline electrolysers are: the current density (to achieve higher production rates); the diaphragm thickness (to achieve higher efficiencies and lower costs); and the design of the electrodes and catalysts. For PEM, the largest cost contribution and potential for reduction comes from the bipolar plates (which provide mechanical support and distribute the flow) and the PTL (which facilitates the mass transport of reactants). Fundamental research on AEM membranes could potentially deliver great benefits in subsequent stages, if a breakthrough is achieved. Similarly, research on lifetime and electrolyte conductivity for solid oxide could unlock a step change in electrolyser performance in the next stage. At this stage, not all companies are familiar with hydrogen and government support is needed to deploy demonstration projects that either provide the bridge between lab and commercial scale, or showcase applications that have been deployed elsewhere with different local conditions.

Stage 2: Scaling up and improving design

- **Manufacturing scale:** The project pipeline is growing quickly, and manufacturing capacity needs to be expanded to support such growth. The largest players are benefiting from economies of scale, reaching the 1 GW/year mark and beyond. This enables a 60%-70% cost reduction in the stack, compared to a MW-scale. Assembly goes from a manual to a semi or fully automated process. Production becomes much more efficient with less wasted materials. Cost contribution from items such as buildings and capital in machinery becomes progressively a smaller share of the total manufacturing cost. Yet, these developments are not widespread and players who take the lead incur a higher risk, with the higher pay out of achieving scale first and a lower manufacturing cost.

- **Module size:** Electrolysers of 20 MW and even 100 MW are now the norm. The balance of plant has now been optimised. There are dedicated suppliers for the electrical equipment, and this is no longer done by electrolyser manufacturers. This enables standardisation and the achievement of lower costs. Power supply is also optimised, with stack design considering variable load and efficiency. Use of pressurised electrolysers allows a reduction in compression needs. The combination of these effects unlocks a lower cost for the auxiliary equipment complementing the advances from R&D for the stack.
- **Learning-by-doing:** Leading manufacturers have built experience with project execution. Some typical business cases are starting to arise, which creates the opportunity to both standardise and optimise the design to satisfy requirements. International players and organisations serve as platforms to exchange lessons and work towards global standards. New manufacturing plants are constructed, which have a much lower cost than their predecessors. Engineering, construction, equipment suppliers, are all familiar with electrolysis, which enables faster project development, leaner execution and lower costs.
- **R&D:** Some of the largest cost tickets for electrolysers have been tackled before. Now, the focus shifts towards material optimisation. If electrolysers are to achieve large scale, the materials used need to decrease in quantity, not only to reduce cost, but also to ensure sustainability and having to increase current supply by several orders of magnitude. For alkaline technology, this means a transition to a platinum and cobaltfree design. This has already been achieved today by some manufacturers, but not all. Keeping these two materials in the design could limit the role that alkaline electrolysers have in the future. For PEM, a combination of reduction, higher hydrogen production and recycling strategies, allows reducing the iridium and platinum content by unit of installed capacity by 70% and 80% respectively. This is particularly important

for iridium, which has currently limited market liquidity (*i.e.* high price volatility of a factor of 15 times between the minimum and maximum over the last 20 years), limited supply diversification (over 85% of the current supply comes from South Africa) and a relatively small market (current supply could only support a capacity of about 75 GW of electrolysis).

Stage 3: A global market

- **Manufacturing scale:** Hydrogen use is growing across all sectors, from planes to ships to trucks and industry. This requires a larger electrolyser production upstream. This creates competition and attracts new players. What in the previous stage was only possible for a few companies, is now more widespread and accessible to multiple enterprises. This in turn creates competition to optimise manufacturing further and have an edge in what is now a market with tighter margins. This race benefits project developers further, since the lowest cost can be achieved.
- **Module size:** There are multiple choices available for project developers. From 100 MW+ modules that are suitable for industrial applications to singledigit MW modules that, by this stage, also incorporate some of the benefits of larger modules. Higher current densities have been achieved for both alkaline and PEM electrolysers, which enables a smaller footprint for all the sizes. AEM and solid oxide have already crossed the boundary from lab to commercialisation and module sizes are in the multi-MW scale.
- **Learning-by-doing:** Deployment still leads to learning, but the largest cost reduction has been achieved by now. The cost starts being dominated by core materials, with an optimised stack and balance of plant. There is still potential for cost reductions in the next generation of electrolysers, AEM and solid oxide.

■ **R&D:** By now, alkaline and PEM have reached maturity with high efficiency, durability and low material use. Research is now driven by private funds rather than public support in the search for proprietary developments and a competitive advantage that delivers a higher market share. New AEM membranes could have been developed by now that combine the best of both worlds (alkaline and PEM), with no expensive titanium, no expensive membrane, high operating

pressure, no electrolyte solution, or tight water requirements. AEM are taking an increasing market share of a burgeoning hydrogen sector. Similarly, solid oxide is now commercial, offering a more efficient option that can be integrated with hydrogendederived products.

Applying these strategies would unlock the low-cost potential of electrolyser, achieving a 40% reduction in the short term and an 80% one in the long-term (see Figure 34).

Figure 34. Potential cost reduction by implementing strategies presented in this report across three stages of deployment.

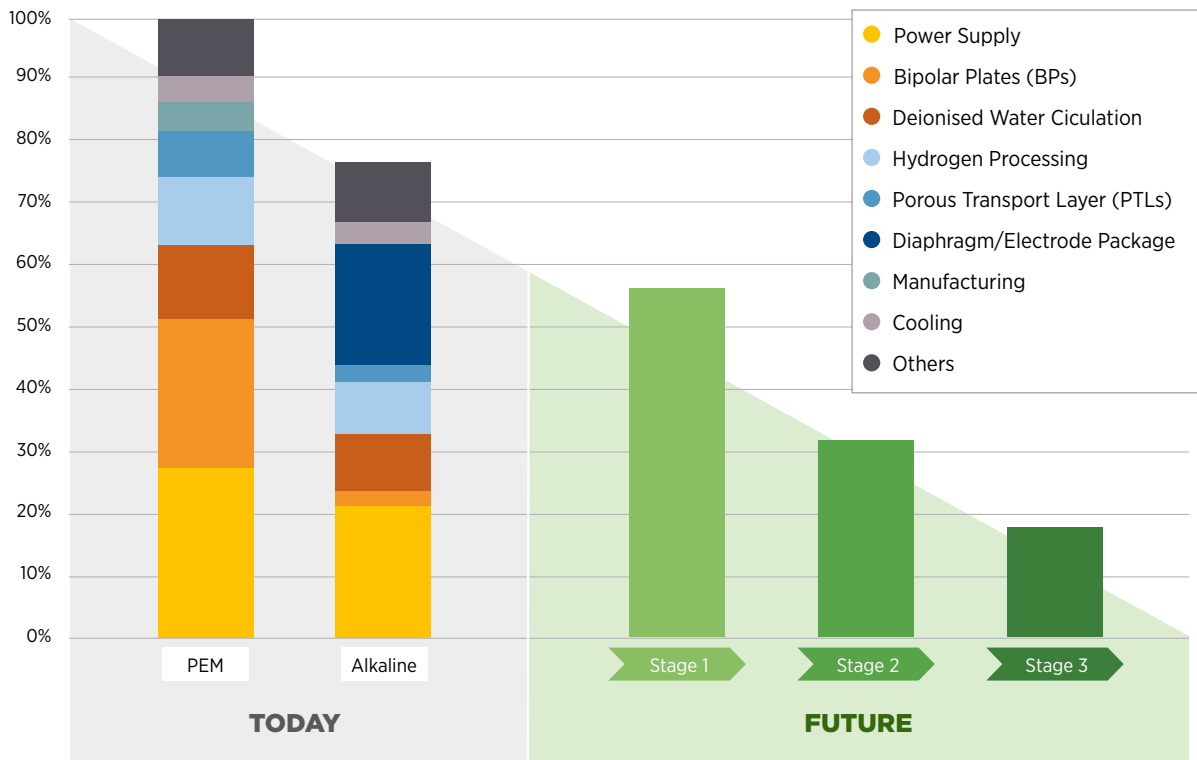

Based on IRENA analysis.

With the goal of achieving green hydrogen competitiveness in mind, the cost of the electrolyser is not the only factor (see Figure 35). Once the operating hours of the electrolyser reach the order of 3 000-4 000 hours per year, the main contributor to the production cost is the electricity price. The

strategies shown in this report will enable a higher efficiency, decreasing the cost contribution of the electricity input. In parallel, renewable electricity – already more competitive than fossil-based electricity in many jurisdictions – will continue scaling up and achieving lower costs.

Figure 35. Step changes for achieving green hydrogen competitiveness.

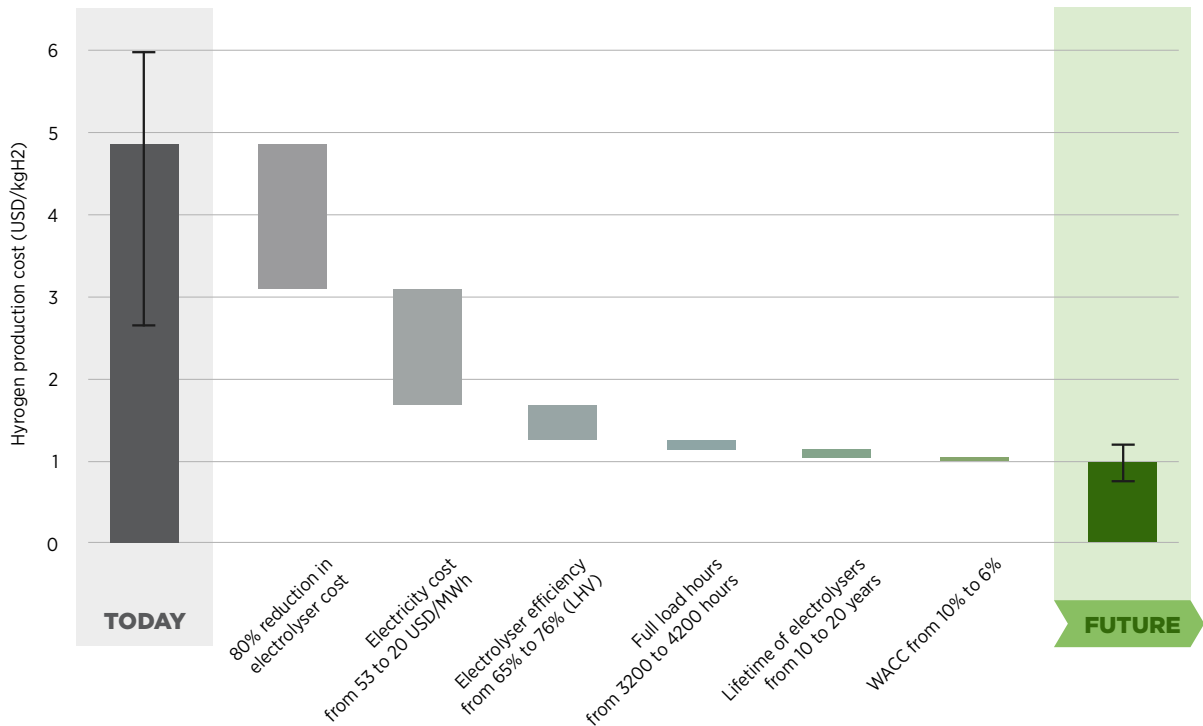

Note: 'Today' captures best and average conditions, with an average investment of USD 770/kW, efficiency of 65% (LHV), an electricity price of USD 53/MWh, 3 200 full load hours (onshore wind), a WACC of 10% (relatively high risk). Best conditions are USD 130/kW, efficiency at 76% (LHV), electricity price at USD 20/MWh, 4 200 full load hours (onshore wind), and WACC of 6% (similar to renewable electricity today).

Based on IRENA analysis.

7.

CONCLUSIONS: STAKEHOLDER ROLES IN SCALING UP

Today, green hydrogen represents only a limited share of global supply. The transition to a future where green hydrogen has not only displaced fossilbased hydrogen, but also gone beyond the industrial sector to become a fuel and energy carrier, will therefore not happen overnight. It will also not happen without the participation of multiple stakeholders. Coordination is key, across four dimensions at least:

- **Across the value chain:** Hydrogen supply (as covered in this report) has to be done in parallel with infrastructure development and, more importantly, demand. At least during the early stages, when a market has not yet developed, production projects need to be codeveloped with an offtaker, since there is no grid or ubiquitous established sink that can absorb all the production. While blending in the gas grid, if combined with tracing and financial compensation, can provide an alternative, it is only an alternative for early stages of development.
- **Across borders:** All sectors, from electrolyzers to fuel cells, direct reduction of steel to ammonia ships and synthetic fuels, will benefit from global collaboration. This applies to the deployment level – enabling learning from projects to drive costs down – and at the research level, enabling the coordination of national programmes.

- **Across sectors:** The green hydrogen covered in this report will benefit from combining different applications to aggregate demand, justifying larger projects and achieving economies of scale that benefit production and, perhaps, infrastructure.
- **Across stakeholders:** Green hydrogen will not scale up without support from multiple stakeholders. Fortunately, there is already widespread interest in hydrogen from energy utilities, steel makers, chemical companies, port authorities, car and airplane manufacturers, shipowners and airlines, amongst others, but their actions need to be in the same direction.

For governments, there are multiple actions that could be pursued to promote green hydrogen production. Most of these will have the largest impact in the early stages of deployment (see Figure 36). Some, however, such as market regulation and financing, will be crucial once the market kicks off and the scale-up process begins. Governments should also adopt a flexible approach in which strategies and targets are frequently reviewed to give consideration to the latest developments. For example, the Australian strategy includes this approach (Strategic Actions 2.1 and 2.2) to remove market barriers and support technology growth, as the market develops.

Figure 36. Main actions and functions for key stakeholders influencing the scale up of green hydrogen.

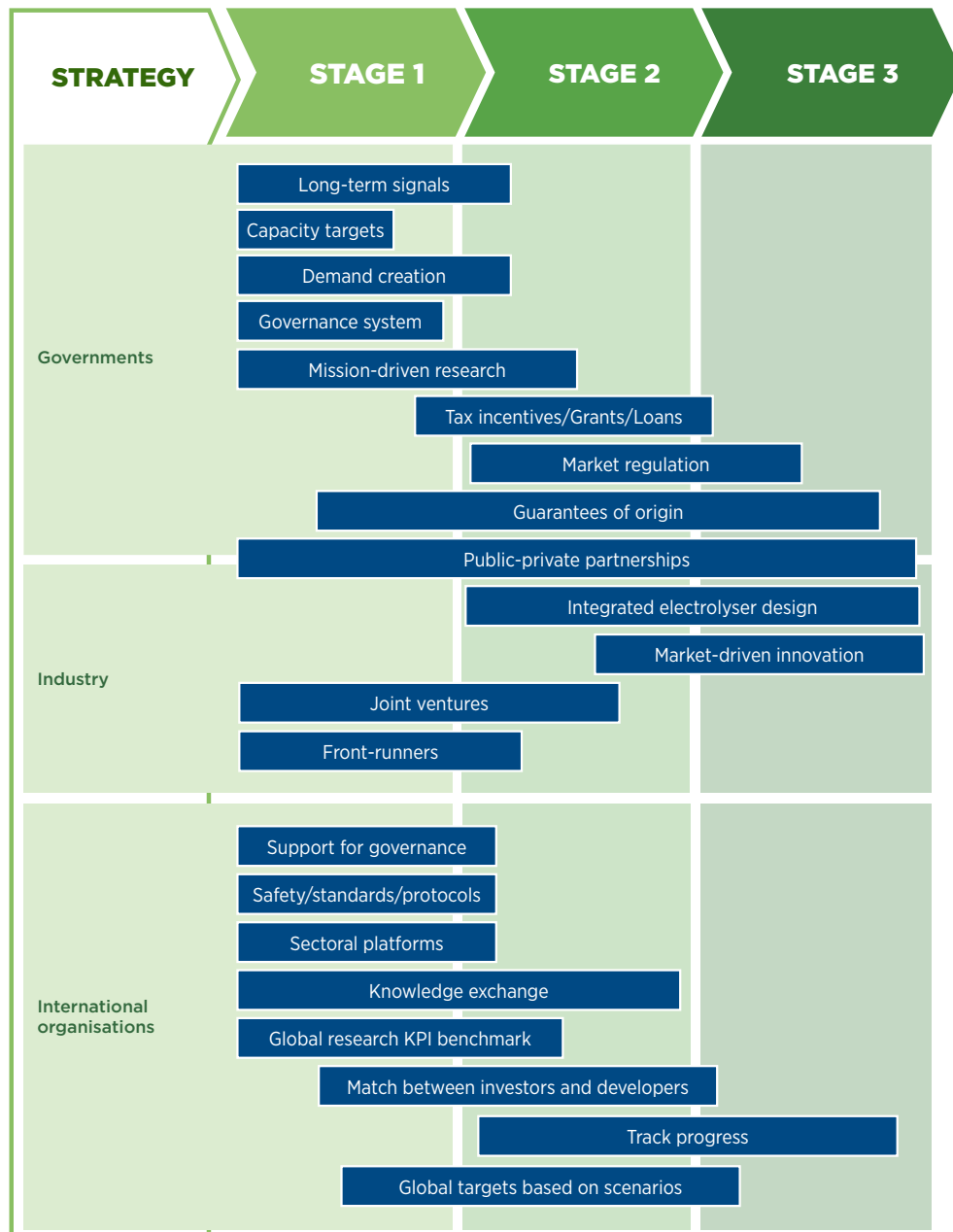

Based on IRENA analysis.

Enabling actions

- **Long-term signals and commitments:** These are necessary to attract private capital, which will be needed for scaling up. For conventional technologies, investors already have long-term horizons, covering the lifetime of assets, aiming to recover the cost and make a profit. For hydrogen production with water electrolysis – a nascent industry – additional certainty from governments is needed to justify the additional risk and investment. This can come in the form of commitment to net-zero emissions targets, since hydrogen is the most useful for hard-to-abate sectors that are required to achieve these targets, or in the form of strategies that set the direction for hydrogen deployment. This commitment to develop hydrogen should ultimately be reflected in the long-term strategies and nationally determined contributions of each country.
- **Market creation:** This will drive demand for green hydrogen. One measure in this is public procurement (e.g. a percentage of green steel for public infrastructure). Blending mandates or quotas are also an attractive alternative. Examples include: requiring a percentage of industrial hydrogen to shift to green, as already covered in French and Portuguese strategies; requiring a percentage of gas demand to be met by green hydrogen, or requiring a percentage of shipping or aviation fuel to be sustainable. Phase-out mandates, similar to those implemented in fossil fuel or nuclear power, or to internal combustion engines in transport, could be used to promote demand by setting a timeline to phase out blast furnaces for steel or fossil fuel-based ships.
- **Standards and certifications:** Uptake for green hydrogen requires that the customer is able to know what the source of the hydrogen is to be able to link it to an additional premium or quota target, while the producer is able to validate lower CO₂ emissions and be remunerated accordingly. This needs to be transparent to be able to communicate

the emissions that have been accounted for (upstream, production, transport, and re-conversion). It also needs to be robust, potentially including more than CO₂ only, to ensure high sustainability standards that are internationally accepted, compatible with other schemes (e.g. electricity and gas) and with an adaptable framework to be adjusted based on lessons learned, once it is deployed.

Governments could also use specific policy instruments for green hydrogen production. Many of these are already outlined in published strategies and the level of these instruments will be better defined once impact assessments are made. The tradeoffs to consider in the policy design for these instruments, as well as examples from around the world, are further explained in the associated briefs of another IRENA publication (IRENA, 2020d). Options include:

- **Capacity targets:** This is the most used measure so far in hydrogen strategies (see Section 1.2). These should be deployed in tandem with an increase in renewable capacity targets (if any) to make sure renewable electricity use for hydrogen does not displace more efficient uses (such as increasing the renewable share of the grid).
- **Financial support:** This can be in the form of grants or concessional loans that decrease the investment risk for industry and close part of the cost differential with fossil-based hydrogen. One example is Australia, where hydrogen is one of the technologies supported under the AUD 1.9 billion investment package for new energy technologies. The Clean Energy Finance Corporation will make AUD 300 million available to support the hydrogen industry and there is also some funding through the Australian Renewable Energy Agency (ARENA), which has a AUD 70 million grant programme aimed at demonstrating the technical and commercial viability of hydrogen production.
- Recent COVID-19 strategies and recovery packages also have financial support for hydrogen (some of which could be used for

electrolysis). Germany has a EUR 7 billion support package, France a EUR 7.2 billion version (EUR 3.4 billion before 2023), while EUR 7 billion is expected to be allocated to the Portuguese strategy. Some of the investment support has already been translated into concrete calls for proposals. These include the solarelectrolysis project in the port of Sines (Portugal), which has received 74 expressions of interest, and the EU call for a 100MW electrolyser for commercial and industrial applications.

- **Blending quotas:** These could be used by either specifying a share of green hydrogen in existing uses, or shares of green hydrogen in final energy demand for specific applications (e.g. similar to the renewable share in transport in the EU). France has already used this approach, specifying 10% of low-carbon hydrogen (potentially from nuclear as well) in industry by 2023 and 20%-40% by 2028. Portugal has also specified blending shares for most enduse sectors from 2020 to 2050, including 2%-5% of green hydrogen in industry by 2030, 10%-15% by 2040 and 20%-25% by 2050.
- **Manufacturing capacity targets:** Some regions are aiming for technology leadership in electrolysis and could use incentives to promote domestic production. For instance, the UK government awarded USD 9.8million (GBP 7.5 million) for a feasibility study to scale up the electrolyser size to 100 MW and the manufacturing capacity to 300 MW/year by 2023 and to 1 GW/year by 2025.
- **Tax incentives:** These could decrease the impact of the high capital cost on project profitability. Alternatives are lower income or sales taxes, or lower tax on the investment. One example is from the Netherlands, where investments resulting in the displacement of fossil fuels are tax deductible (the tax rate is up to 41.5%). The incoming US administration is considering the introduction of a production tax credit of USD 0.42/kg for clean hydrogen and hydrogen carriers – based on emissions intensity – and a manufacturers production tax credit of USD 500/kW. Similar incentives

were fundamental for the deployment of wind and battery electric vehicles respectively.

- **Green hydrogen premium:** This could be through feed-in tariffs or contracts for difference. An example where this is already applied is the SDE++ program in the Netherlands, which is set to provide subsidies for the production of hydrogen from electrolysis (RVO, 2020).

Governments undertake all this alone, however. Industry and private capital are other key components (see Figure 36). One of the actions industry can take is to form joint ventures. These can diversify the risk for large projects that are firstofakind, while still allowing all parties to benefit from experience in the project.

A recent (November 2020) example is a 20 MW green hydrogen project in China, where hydrogen will be used for road transport as a joint venture between Shell and Zhangjiakou City Transport. Industrial manufacturers can contribute to the lower cost by standardising the designs, which can then be replicated from one project to another, reducing engineering costs, learning from construction and reducing delays. Some companies could also invest in electrolysis, given its good prospects for the future, aiming to take the lead and a high share of a burgeoning market. The reward for the high risk for being a front runner is that of becoming a dominant player in the future market. Once the market develops, research can transition to be dominated by private efforts aiming to improve competitiveness and achieving a larger market share.

In addition, international organisations can serve to: exchange knowledge; bring together governments and industry; set the global needs for electrolysis deployment; track progress towards deployment targets; implement policies and cost decreases; support the development of national strategies; perform scenario analysis to set the global needs for electrolysis to be in line with a sustainable future; identify new business models; and analyse specific case studies.

IRENA covers many of these activities under the Collaborative Framework for Green Hydrogen and will continue to support member states in these aspects. For standards and certification, the International Partnership for Fuel Cells and Hydrogen in the Economy has a specific standing Working Group on Regulations, Codes, Standards and Safety and has a dedicated task force on hydrogen production analysis. IRENA aims to support this initiative and bring together member states that are working on certification.

This report uses a single representative cost for technology today to estimate the potential cost reduction in the future. This cost can vary widely, however, by manufacturer, country of origin, design, location, project scope and application. Part of the underlying problem is limited data availability, given an early stage market that sees strong competition between manufacturers and protection of intellectual property.

Another issue is that many of the current cost estimates are for small-scale projects with limited volumes of manufacturing capacity. Estimates for large-scale production are therefore based on engineering, rather than actual values from implementation. Scale-up of manufacturing facilities will bring significant cost reduction, due to automation of the manufacturing process, as well as standardisation of components.

What governments can do is to promote transparency and openness and link any public support with a disclosure requirement for the project data. This would allow efforts from other parts of society, such as universities and research institutes, to be channelled towards analysing such data and working towards closing the gaps, rather than leaving this effort to private industry and market competition alone.

This would not be unprecedented for hydrogen, with such practices already being followed in California through the Low-Carbon Fuel Standard (LCFS)²⁵ and Europe by the Fuel Cells and Hydrogen Joint Undertaking (FCH JU), but these are currently limited to the overseeing bodies and not fully public.

Most of the attention, notably, is currently on projects with European manufacturers, while little is known about the cost and performance of technologies from other regions, with few exceptions. In the years to come, more projects of larger scale will lead to better price discovery and will allow us to refine cost estimates, as well as cost projections.

At this stage, a floor cost is also difficult to establish, as many of the components are likely to undergo significant reengineering as manufacturing capacity and project scale increases rapidly. In the face of such uncertainties, governments can create stable demand through policies and regulation, to create a predictable project pipeline that would allow for investments in scaling up manufacturing, as well as the necessary investments in RD&D.

A current uncertainty that could turn into a potential upside is the progress that can be achieved for AEM and solid oxide. While these two technologies are at their early stages today, they can represent a step change in performance. AEM has the promise of being free from scarce raw materials, is a less expensive and more environmentally friendly membrane, and can operate at differential pressure. Solid oxide has the promise of much higher efficiency, which translates into lower electricity costs. What governments can do in this respect is to have these technologies as part of research programmes and not only focus scale-up efforts on technologies that are already commercial.

Finally, ongoing innovation can be expected to improve viability and even provide new alternatives. The main focus currently is on electrolysis as the key pathway for green hydrogen production, where innovation is likely to further reduce costs and improve electrolyser performance. This may also result in completely new technologies, however, in the production of hydrogen with renewables (IRENA, 2018).

REFERENCES

- Australian Government (2020)**, *Technology investment roadmap: First low emissions technology statement – 2020*, Department of Industry, Science, Energy and Resources, pp. 44, www.industry.gov.au/sites/default/files/September%202020/document/first-low-emissions-technology-statement-2020.pdf.
- Babic, U. et al. (2017)**, “Critical review—Identifying critical gaps for polymer electrolyte water electrolysis development”, *Journal of the Electrochemical Society*, Vol. 164/4, pp. F387, <https://dx.doi.org/10.1149/2.1441704jes>.
- Bergen, F. (2019)**, *Electricity-based fuels as a link between the electricity and transport sectors*, ETIP Wind Workshop, <https://etipwind.eu/wp-content/uploads/A5-Siemens.pdf>
- BNEF (2019)**, *Hydrogen: The economics of storage. Storing clean molecules at scale*. Bloomberg New Energy Finance.
- Böhm, H. et al. (2020)**, “Projecting cost development for future large-scale power-to-gas implementations by scaling effects”, *Applied Energy*, Vol. 264, pp. 114780, <https://dx.doi.org/10.1016/j.apenergy.2020.114780>.
- Böhm, H., S. Goers, and A. Zauner (2019)**, “Estimating future costs of power-to-gas – a component-based approach for technological learning”, *International Journal of Hydrogen Energy*, Vol. 44/59, pp. 3078930805, <https://dx.doi.org/10.1016/j.ijhydene.2019.09.230>.
- Cihlar, J. et al. (2020)**, *Hydrogen generation in Europe: Overview of key costs and benefits*, <https://dx.doi.org/10.2833/122757>.
- Diesendorf, M. and Elliston, B. (2018)**, “The feasibility of 100% renewable electricity systems: A response to critics”, *Renewable and Sustainable Energy Reviews*, Vol. 93, pp. 318330, <https://dx.doi.org/10.1016/j.rser.2018.05.042>.
- Duclos, L. et al. (2017)**, “Environmental assessment of proton exchange membrane fuel cell platinum catalyst recycling”, *Journal of Cleaner Production*, Vol. 142, Part 4, pp. 26182628, <https://dx.doi.org/10.1016/j.jclepro.2016.10.197>.
- E4tech (2014)**, *Study on development of water electrolysis in the EU*, E4tech Sàrl with Element Energy Ltd for the Fuel Cells and Hydrogen Joint Undertaking, [https://www.fch.europa.eu/sites/default/files/FCHJUElectrolysisStudy_FullReport%20\(ID%20199214\).pdf](https://www.fch.europa.eu/sites/default/files/FCHJUElectrolysisStudy_FullReport%20(ID%20199214).pdf).
- Eichman, J., K. Harrison and M. Peters (2014)**, *Novel electrolyzer applications: Providing more than just hydrogen*, NREL/TP-5400-61758, National Renewable Energy Laboratory, Golden, CO, United States, <https://dx.doi.org/10.2172/1159377>.
- European Commission (2020)**, *Study on the EU’s list of critical raw materials (2020)*, European Commission, Brussels.
- FCH JU (2019)**, *Fuel Cells and Hydrogen 2 Joint Undertaking - Addendum to the multi-annual work plan 2014 - 2020*, Fuel Cells and Hydrogen Joint Undertaking, www.fch.europa.eu/sites/default/files/MAWP_final_version_endorsed_GB_15062018_%28ID_3712421%29.pdf.

FCW (2020), *Asahi Kasei's electrolysis system starts world's largest-scale hydrogen supply operation at the Fukushima Hydrogen Energy Research Field in Namie*, Fuel Cells Works, <https://fuelcellsworks.com/news/asahi-kaseis-electrolysis-system-starts-worlds-largest-scale-hydrogen-supply-operation-at-the-fukushima-hydrogen-energy-research-field-in-namie/>.

Garside, M. (2019), *Demand for iridium worldwide from 2010 to 2019*, Statista, www.statista.com/statistics/585840/demand-for-iridium-worldwide/ (accessed 16 October 2020).

Gül, T. et al. (2009), "An energy-economic scenario analysis of alternative fuels for personal transport using the Global Multi-regional MARKAL model (GMM)", *Energy*, Vol. 34/10, pp. 14231437, <https://dx.doi.org/10.1016/j.energy.2009.04.010>.

Hand, S., J.S. Guest and R.D. Cusick (2019), "Technoeconomic analysis of brackish water capacitive deionization: Navigating tradeoffs between performance, lifetime, and material costs", *Environmental Science & Technology*, Vol. 53/22, pp. 1335313363, <https://dx.doi.org/10.1021/acs.est.9b04347>.

Hermann, A., T. Chaudhuri and P. Spagnol (2005), "Bipolar plates for PEM fuel cells: A review", *International Journal of Hydrogen Energy*, Vol. 30/12, pp. 12971302, <https://dx.doi.org/10.1016/j.ijhydene.2005.04.016>.

Hmiel, B. et al. (2020), "Preindustrial 14CH_4 indicates greater anthropogenic fossil CH_4 emissions", *Nature*, Vol. 578/7795, pp. 409412, <https://dx.doi.org/10.1038/s41586-020-1991-8>.

Hydrogen Council (2020), *Path to hydrogen competitiveness - A cost perspective*, Hydrogen Council, <https://hydrogencouncil.com/en/path-to-hydrogen-competitiveness-a-cost-perspective/>.

IEA (2020), *Energy technology perspectives: Special report on clean energy innovation*, International Energy Agency, Paris.

IEA TCP (n.d.), *Data provided by IEA Hydrogen Technology Collaboration Programme*, Task 38.

IRENA (2020a), *Renewable Power Generation Costs in 2019*, International Renewable Energy Agency, Abu Dhabi, www.irena.org/publications/2020/Jun/Renewable-Power-Costs-in-2019.

IRENA (2020b), *Global renewables outlook: Energy transformation 2050 (Edition 2020)*, pp. 212, International Renewable Energy Agency, Abu Dhabi, <https://irena.org/publications/2020/Apr/Global-Renewables-Outlook-2020>.

IRENA (2020c), *Reaching zero with renewables: Eliminating CO₂ emissions from industry and transport in line with the 1.5°C climate goal*, International Renewable Energy Agency, Abu Dhabi, www.irena.org/publications/2020/Sep/Reaching-Zero-with-Renewables.

IRENA (2020d), *Green hydrogen: A guide to policy making*, International Renewable Energy Agency, Abu Dhabi, <https://irena.org/publications/2020/Nov/Green-hydrogen>.

IRENA (2020e), *Renewable energy policies in a time of transition: Heating and cooling*. International Renewable Energy Agency, Abu Dhabi, <https://irena.org/publications/2020/Nov/Renewable-Energy-Policies-in-a-Time-of-Transition-Heating-and-Cooling>

IRENA (2020f), *Electricity storage valuation framework: Assessing system value and ensuring project viability*, pp. 112, International Renewable Energy Agency, Abu Dhabi, <https://irena.org/publications/2020/Mar/Electricity-Storage-Valuation-Framework-2020>.

IRENA (2019a), *Hydrogen: A renewable energy perspective*, International Renewable Energy Agency, Abu Dhabi, www.irena.org/publications/2019/Sep/Hydrogen-A-renewable-energy-perspective.

IRENA (2019b), *Demand-side flexibility for power sector transformation*, International Renewable Energy Agency, Abu Dhabi, www.irena.org/publications/2019/Dec/Demand-side-flexibility-for-power-sector-transformation.

IRENA (2018), *Hydrogen from renewable power: Technology outlook for the energy transition*, International Renewable Energy Agency, Abu Dhabi, www.irena.org/publications/2018/Sep/Hydrogen-from-renewable-power.

IRENA (2015), *Renewable energy in the water, energy & food nexus*, International Renewable Energy Agency, Abu Dhabi, www.irena.org/publications/2015/Jan/Renewable-Energy-in-the-Water-Energy--Food-Nexus.

ITM Power (2017), *Scaling PEM electrolysis to 100 MW*, Hannover Messe, Germany, <https://cam1.h2fc-fair.com/hm17/images/forum/2017-04-25-1100.pdf>.

Kang, Z. et al. (2020), “Effects of various parameters of different porous transport layers in proton exchange membrane water electrolysis”, *Electrochimica Acta*, Vol. 354, pp. 136641, <https://dx.doi.org/10.1016/j.electacta.2020.136641>.

Kim, H.-S. et al. (2013), “High-efficiency isolated bidirectional AC-DC converter for a DC distribution system”, *IEEE Transactions on Power Electronics*, Vol. 28/4, pp. 16421654, <https://dx.doi.org/10.1109/TPEL.2012.2213347>.

Liu, C. et al. (2018), “Performance enhancement of PEM electrolyzers through iridium-coated titanium porous transport layers”, *Electrochemistry Communications*, Vol. 97, pp. 9699, <https://dx.doi.org/10.1016/j.elecom.2018.10.021>.

Mayyas, A. et al. (2019), *Manufacturing cost analysis for proton exchange membrane water electrolyzers*, Technical Report NREL/TP-6A20-72740, National Renewable Energy Laboratory, Golden, CO, United States.

Mayyas, A. and M. Mann (2019), “Emerging manufacturing technologies for fuel cells and electrolyzers”, *Procedia Manufacturing*, Vol. 33, pp. 508515, <https://dx.doi.org/10.1016/j.promfg.2019.04.063>.

McDowall, W. (2012), *Endogenous technology learning for hydrogen and fuel cell technology in UKSHEC II: Literature review, research questions and data*, UKSHEC Working Paper 8, https://www.lifestudy.ac.uk/bartlett/energy/research/themes/energy-systems/hydrogen/WP8_McDowall_ETL_1_.pdf

McKinsey (2010), *A portfolio of power-trains for Europe: A fact-based analysis*, McKinsey & Company, www.fch.europa.eu/sites/default/files/Power_trains_for_Europe_0.pdf.

McPhy (2020), *Electrolyzers: The production of industrial hydrogen on-site, on demand, according to your specifications*, McPhy Energy, <https://mcphy.com/en/equipment-services/electrolyzers/?cn-reloaded=1>.

Mehmeti, A. et al. (2018), “Life cycle assessment and water footprint of hydrogen production methods: From conventional to emerging technologies”, *Environments*, Vol. 5, pp 19, <http://dx.doi.org/10.3390/environments5020000>.

Nel (2019), *Nel hydrogen electrolyzers*, Nel, <https://nelhydrogen.com/wp-content/uploads/2020/03/Electrolysers-Brochure-Rev-C.pdf>.

Noack, C. et al. (2015), „Studie über die Planung einer Demonstrationsanlage zur Wasserstoff-Kraftstoffgewinnung durch Elektrolyse mit Zwischenspeicherung in Salzkavernen unter Druck“ [Study on the planning of a demonstration system for hydrogen fuel production by electrolysis with intermediate storage in salt caverns under pressure], <https://elib.dlr.de/94979/> (accessed 2 November 2020).

van 't Noordende, H. and P. Ripson (2020), *Gigawatt green hydrogen plant: State-of-the-art design and total installed capital costs*, Institute for Sustainable Process Technology (ISPT), <https://ispt.eu/media/ISPT-public-report-gigawatt-green-hydrogen-plant.pdf>.

NOW (2018), „Studie IndWEDe - Industrialisierung der Wasserelektrolyse in Deutschland: Chancen und Herausforderungen für nachhaltigen Wasserstoff für Verkehr, Strom und Wärme“ [Study IndWEDe - industrialisation of water electrolysis in Germany: Opportunities and challenges for sustainable hydrogen for transport, electricity and heat], Nationale Organisation Wasserstoff- und Brennstoffzellentechnologie, Berlin, http://publica.fraunhofer.de/eprints/urn_nbn_de_0011-n-5194940.pdf.

Nuss, P. and E. Matthew (2014), „Life cycle assessment of metals: A scientific synthesis“, *Metals Environmental Impacts*, Vol. 9/7, <https://journals.plos.org/plosone/article?id=10.1371/journal.pone.0101298> (accessed 16 October 2020).

Ozarslan, A. (2012), „Large-scale hydrogen energy storage in salt caverns“, *International Journal of Hydrogen Energy*, Vol. 37/19, pp. 1426514277, <https://dx.doi.org/10.1016/j.ijhydene.2012.07.111>.

Proost, J. (2020), „Critical assessment of the production scale required for fossil parity of green electrolytic hydrogen“, *International Journal of Hydrogen Energy*, Vol. 45/35, pp. 1706717075, <https://dx.doi.org/10.1016/j.ijhydene.2020.04.259>.

Reddy, K.V. and N. Ghaffour (2007), „Overview of the cost of desalinated water and costing methodologies“, *Desalination*, Vol. 205/1, pp. 340353, <https://dx.doi.org/10.1016/j.desal.2006.03.558>.

Saba, S.M. et al. (2018), „The investment costs of electrolysis - A comparison of cost studies from the past 30 years“, *International Journal of Hydrogen Energy*, Vol. 43/3, pp. 12091223, <https://dx.doi.org/10.1016/j.ijhydene.2017.11.115>.

Santos, D.M.F., C.A.C. Sequeira and J.L. Figueiredo (2013), „Hydrogen production by alkaline water electrolysis“, *Química Nova*, Vol. 36, pp. 11761193.

Schalenbach, M. et al. (2016), „Acidic or alkaline? Towards a new perspective on the efficiency of water electrolysis“, *Journal of the Electrochemical Society*, Vol. 163/11, pp. F3197, <https://dx.doi.org/10.1149/2.0271611jes>.

Schmidt, O. et al. (2017), „The future cost of electrical energy storage based on experience rates“, *Nature Energy*, Vol. 2/8, <https://dx.doi.org/10.1038/nenergy.2017.110>.

Schoots, K. et al. (2008), „Learning curves for hydrogen production technology: An assessment of observed cost reductions“, *International Journal of Hydrogen Energy*, Vol. 33/11, pp. 26302645, <https://dx.doi.org/10.1016/j.ijhydene.2008.03.011>.

Schoots, K., G.J. Kramer and B.C.C. van der Zwaan (2010), „Technology learning for fuel cells: An assessment of past and potential cost reductions“, *Energy Policy*, Vol. 38/6, pp. 28872897, <https://dx.doi.org/10.1016/j.enpol.2010.01.022>.

Siemens (2020), *Silyzer 300 electrolyser*, Nuremberg, Germany, <https://assets.siemens-energy.com/siemens/assets/api/uuid:ffa44e5d-1207-46d3-808f-e759f03282b8/datasheet-neu.pdf>.

Shi, X., Liao X. and L. Yanfei (2020), “Quantification of fresh water consumption and scarcity footprints of hydrogen from water electrolysis: A methodology framework”, *Renewable Energy*, Vol. 154, pp. 786-796, <https://doi.org/10.1016/j.renene.2020.03.026>.

Staffell, I. and R. Green (2013), “The cost of domestic fuel cell micro-CHP systems”, *International Journal of Hydrogen Energy*, Vol. 38/2, pp. 10881102, <https://dx.doi.org/10.1016/j.ijhydene.2012.10.090>.

The CCAC Oil & Gas Methane Partnership (n.d.), Climate & Clean Air Coalition, <https://www.ccacoalition.org/en/activity/ccac-oil-gas-methane-partnership> (accessed 17 November 2020).

Thyssenkrupp (2020), *Thyssenkrupp’s water electrolysis technology qualified as primary control reserve – E.ON and thyssenkrupp bring hydrogen production to the electricity market*, www.thyssenkrupp.com/en/newsroom/press-releases/pressdetailpage/thyssenkrupps-water-electrolysis-technology-qualified-as-primary-control-reserve--eon-and-thyssenkrupp-bring-hydrogen-production-to-the-electricity-market-83355.

Thyssenkrupp (2018), *Hydrogen from large-scale electrolysis - Efficient solutions for sustainable chemicals and energy storage*, Thyssenkrupp, https://ucpcdn.thyssenkrupp.com/_binary/CPthyssenkruppBAISUhdeChlorineEngineers/en/products/water-electrolysis-hydrogen-production/alkaline-water-electrolysis/link-thyssenkrupp_Hydrogen_Water_Electrolysis_and_green_chemicals.pdf.

Van Berkel, F. et al. (2020), *Green hydrogen economy in the EU: The critical materials perspective. Strategies for the reduction of critical material used in electrolyser stacks*, TNO.

Walnum, H.T. et al. (2013), *Report on modelling of large-scale high-efficiency IDEALHY hydrogen liquefier concept*, FCH JU, www.idealhy.eu/uploads/documents/IDEALHY_D2-4_Modelling_High-Efficiency_Concept_web.pdf.

Wei, M., S.J. Smith and M.D. Sohn (2017a), “Experience curve development and cost reduction disaggregation for fuel cell markets in Japan and the US”, *Applied Energy*, Vol. 191, pp. 346357, <https://dx.doi.org/10.1016/j.apenergy.2017.01.056>.

Wei, M., S.J. Smith and M.D. Sohn (2017b), “Non-constant learning rates in retrospective experience curve analyses and their correlation to deployment programs”, *Energy Policy*, Vol. 107, pp. 356369, <https://dx.doi.org/10.1016/j.enpol.2017.04.035>.

Wong, Q. (2020), *Facebook plans to use AI to help fight climate change*, CNET, www.cnet.com/news/facebook-plans-to-use-ai-to-help-fight-climate-change/ (accessed 15 October 2020).

World Bank (2020), *Green hydrogen in developing countries, Energy Sector Management Assistance Program – World Bank*, Washington, DC, <http://documents1.worldbank.org/curated/en/953571597951239276/pdf/Green-Hydrogen-in-Developing-Countries.pdf> (accessed 6 November 2020).

ABBREVIATIONS

A/cm²	Amperes per square centimetre	GW/year	Gigawatts per year
AEM	Anion exchange membrane	H₂	Hydrogen
Al	Aluminium	ha	Hectares
ASTM	American Society for Testing and Materials	IRESEN	Research Institute on Solar Energy and New Energies (Institut de Recherche en Energie Solaire et Energies Nouvelles – Morocco)
atm	Standard atmospheres	ISPT	Institute for Sustainable Process Technology
B	Boron	kg	Kilogramme
BEV	Battery electric vehicle	km²	Square kilometre
BOP	Bill of process	KOH	Potassium hydroxide
CCM	Catalystcoated membrane	KPI	Key performance indicator
CCS	Carbon capture and storage	kW	Kilowatt
CHA	Clean Hydrogen Alliance	kWh/kg H₂	Kilowatt hours per kilogramme of hydrogen
cm²	Square centimetres	LCSF	Low Carbon Fuel Standard
Cr	Chromium	LHV	Lower heating value
Cu	Copper	LNG	Liquefied natural gas
EJ	Exajoules	LSF	Lanthanum ferrite
EPC	Engineering, procurement and construction	LSM	Lanthanum magnate
EU	European Union	M³	Cubic metre
EV	Electric vehicle	MASEN	Moroccan Agency for Sustainable Energy
FCEV	Fuel cell electric vehicle	MEA	Membrane electrode assembly
FCH JU	Fuel Cells and Hydrogen Joint Undertaking	METI	Ministry of Economy, Trade and Industry (Japan)
Fe	Iron	mg	Milligram
FEED	Front end engineering and design	µm	Micrometres
FFR	Fast frequency response	mm	Millimetre
GHG	Greenhouse gas	Mol^{*L-1}	Moles of solute per litre of solution
GJ	Gigajoules		
g/kW	Grammes per kilowatt		
GtCO₂	Gigatonnes of carbon dioxide		

MtH₂/year	Million tonnes of hydrogen per year
MWh	Megawatt hour
NaHCO₃	Sodium bicarbonate
Ni	Nickel
NiAl	NickelAluminium
Ni(OH)₂	Nickel hydroxide
NiZn	NickelZinc
nm	Nanometres
O₂	Oxygen
OEM	Original equipment manufacturer
OPEX	Operational expenditure
PEM	Polymer electrolyte membrane
PFSA	Perfluorosulfonic acid
PTL	Porous transport layer
PtX	Power to X
PV	Photovoltaic
R&D	Research and development
RD&D	Research, design and development
Si	Silicon
SiO₂	Silicon dioxide
SOEC	Solid oxide electrolyser cell
tCO₂	Tonnes of carbon dioxide
TES	Transforming Energy Scenario (IRENA)
TW	Terawatt
TWh	Terawatt hour
t/year	Tonnes per year
V	Volt
VRE	Variable renewable energy
WACC	Weighted average cost of capital
ZrO₂	Zirconium oxide

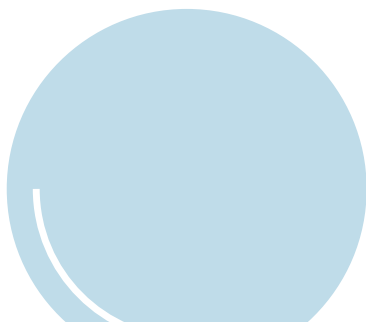
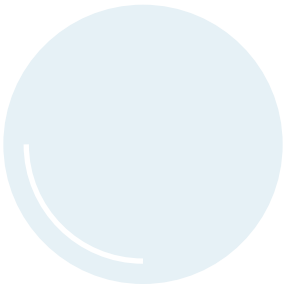





www.irena.org

© 2020