

IRENA FlexTool

Basic Training





Contents

-
1. [Introducing FlexTool](#)
 2. [Installing FlexTool](#)
 3. [Main features and assumptions, strengths and weaknesses of the tool](#)
 4. [Designing a FlexTool flexibility assessment](#)
 5. [Introducing demo models for training](#)
 6. [Running flexibility assessments with demo models – Demo Model 1](#)
 7. [Running flexibility assessments with demo models – Demo Model 2](#)

Introducing the FlexTool

1. FlexTool license

- IRENA FlexTool is a free software
- Redistribute or modify under GNU Lesser General Public License

2. Ongoing development

- The main branch is actively developed by IRENA and VTT Technical Research Centre of Finland
- New versions will be announced on [irena.org](https://www.irena.org)

3. Future developments

- New features are developed according to user needs and wishes
- Any suggestions/comments can be submitted to Flextool@irena.org

Support documents

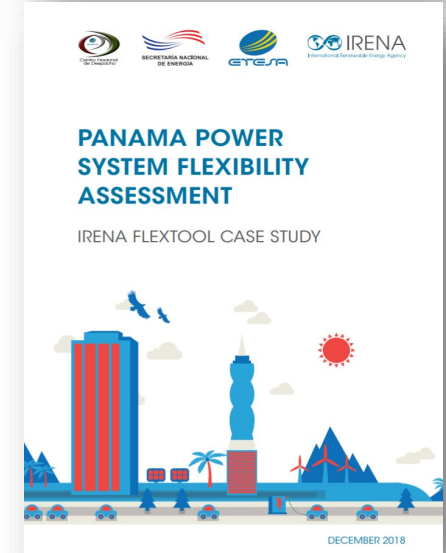
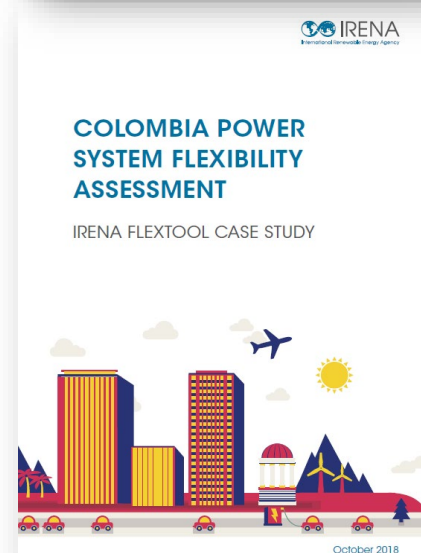
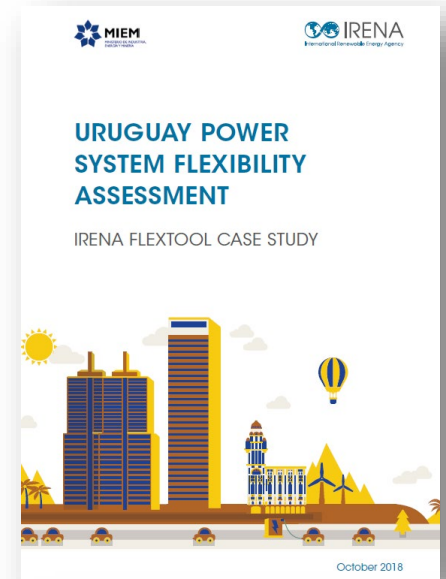
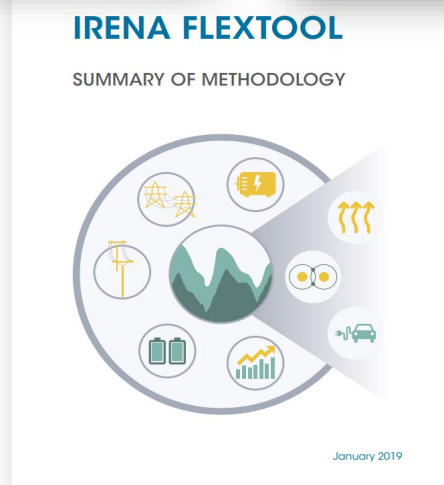
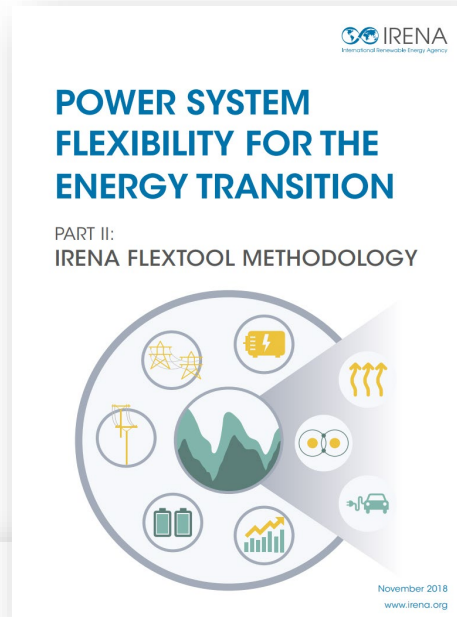
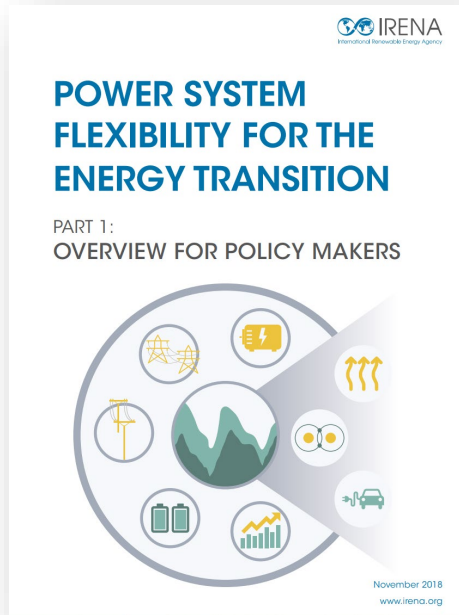

Main files (1-3)

FlexTool involves three main files:

1. flexTool.xlsm file (MS Excel)
2. Input-data files (MS Excel)
3. Result files (MS Excel)

Users must be Excel-enabled:



1. flexTool.xlsm (MS Excel)

- Main user interface:
 - Select used model and scenarios,
 - Run the model,
 - Print selected results

Screenshot: flexTool.xlsm

[Sensitivity definitions](#)
[Settings and filters](#)

IRENA FlexTool

Run Scenarios

Import results

Import summary only

Write time series and Run Scenarios

Options for the modelling process:

- Leave results file open after importing results
- Import results after optimisation
- Create plots in the results file
- Use parallel calculation (no. of threads in the settings sheet)
- Run in the background

Active input files:	Inactive input files:	Active scenarios:	Inactive scenarios:
template.xlsm	<->	Base	<->
	<-> template-transmission.xlsm		<-> Invest
	<-> template-storage.xlsm		<-> hydro-minus15p
	<-> template-EVs.xlsm		<-> hydro-plus15p
	<-> template-demandResponse.xlsm		<-> hydro-minus15p-invest
	<-> template-CSP.xlsm		<-> template_storageMW
	<-> template-17520.xlsm		<-> template_storageFree

Instructions

General

- This file contains macros. Macros must be enabled for this sheet and for Excel in general. See 'Getting Started' for more info.
- Edit only blue and light blue cells

Run scenarios:

- Tool will run all the active scenarios in the right selection for all the active input files in the left selection
- Swap scenarios or input files on or off using the green arrows

Main files: (2) Data input

2. Input-data files (MS Excel)

- Input data files define the model version
- flexTool.xlsm is the same for all countries, input data is unique
- Every model year needs its own input data file (e.g., Thailand 2019, Thailand 2030)

	A	B	C	D	E	F	G	H	I	J	K	L	M	N	O	P	Q
					demand (MWh)	import (MWh)	capacity margin (MW)	non synchronous share	inertia limit (Mw s)	use ts_reserve	use dynamic reserve	print results	color in results	Add empty row			
1	grid	node	nodeGroup	nodeGroup2													
2	elec	nodeA	sync1	reserve1	10000000	10000	67	0.8		1	1	1					
3	elec	nodeB	sync1	reserve1	16000000		260	0.8		0	0	1					
4	csp	B_CSP			0			1.0		0	0	0					
5	elec	nodeC		reserve1	9000000		130	0.8		0	0	1					
6	heat	heatA			10000000					0	0	1					
7																	
8																	
9																	
10																	
11																	

Screenshot of the input data file

3. Result files (MS Excel)

- Results show in large amounts, from summaries to more detailed ones
- User has the possibility to show only one scenario or to compare results from multiple scenarios

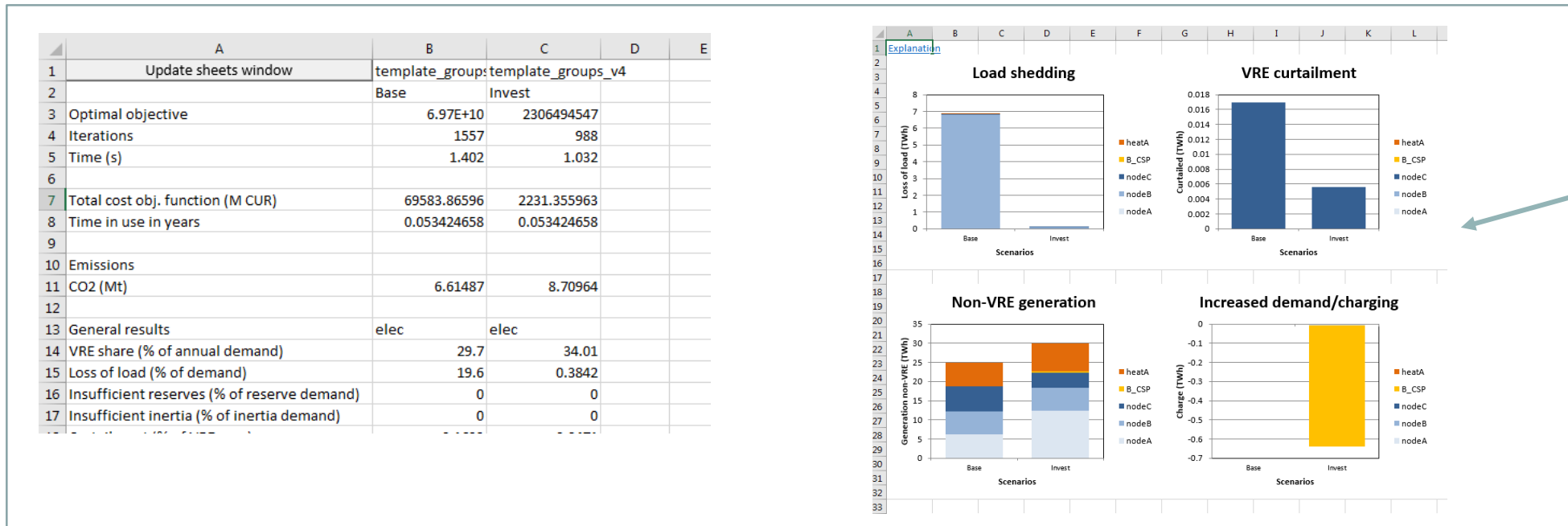

Screenshots of the results file

1. First public version (November 2018)

2. Version 1.2 (April 2019)

- New features were added for multinode models and improved result printing

3. Version 2.0 (April 2020)

- Added units with multiple outputs (*e.g.*, CHP units), better unit specific constraints (*e.g.*, minimum and maximum generation, fixed generation, etc.)
- Further improvements in results printing

Install and test the FlexTool



Steps to install IRENA FlexTool

IRENA FlexTool can be installed and run in just **five steps**:

1. Create folders and copy files
2. Enable macros in flexTool.xlsm Excel file
3. Run existing demo model
4. Introduction to results file
5. Batch run – Running both dispatch and investment modes



Create folders and copy files, 1/2

1. Create a folder for FlexTool (e.g., c:\FlexTool)

- Install folder is called root folder

2. Copy zipped FlexTool install package to the new folder

- File is named as flexTool_YYYY_MM_DD.zip (e.g., FlexTool_2019_11_03.zip)
- Check from file name which version (date) of the tool you are installing

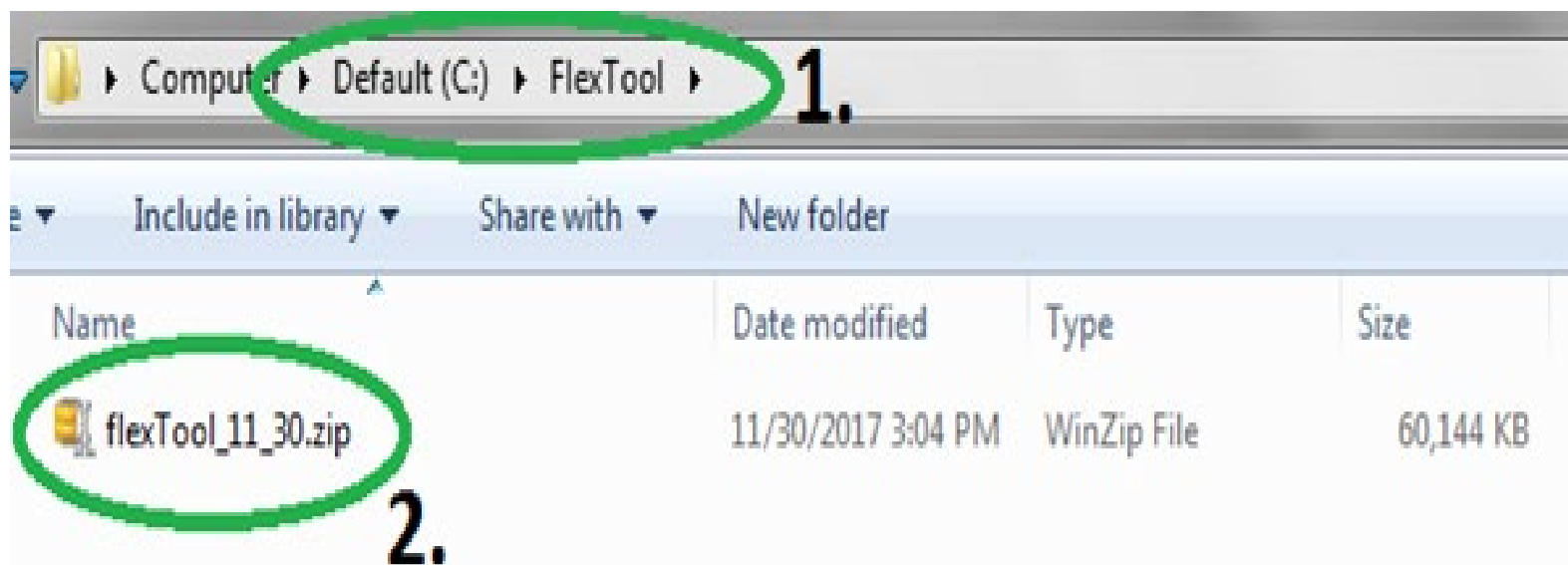

Create folders and copy files, 2/2

3. Unzip files to root folder

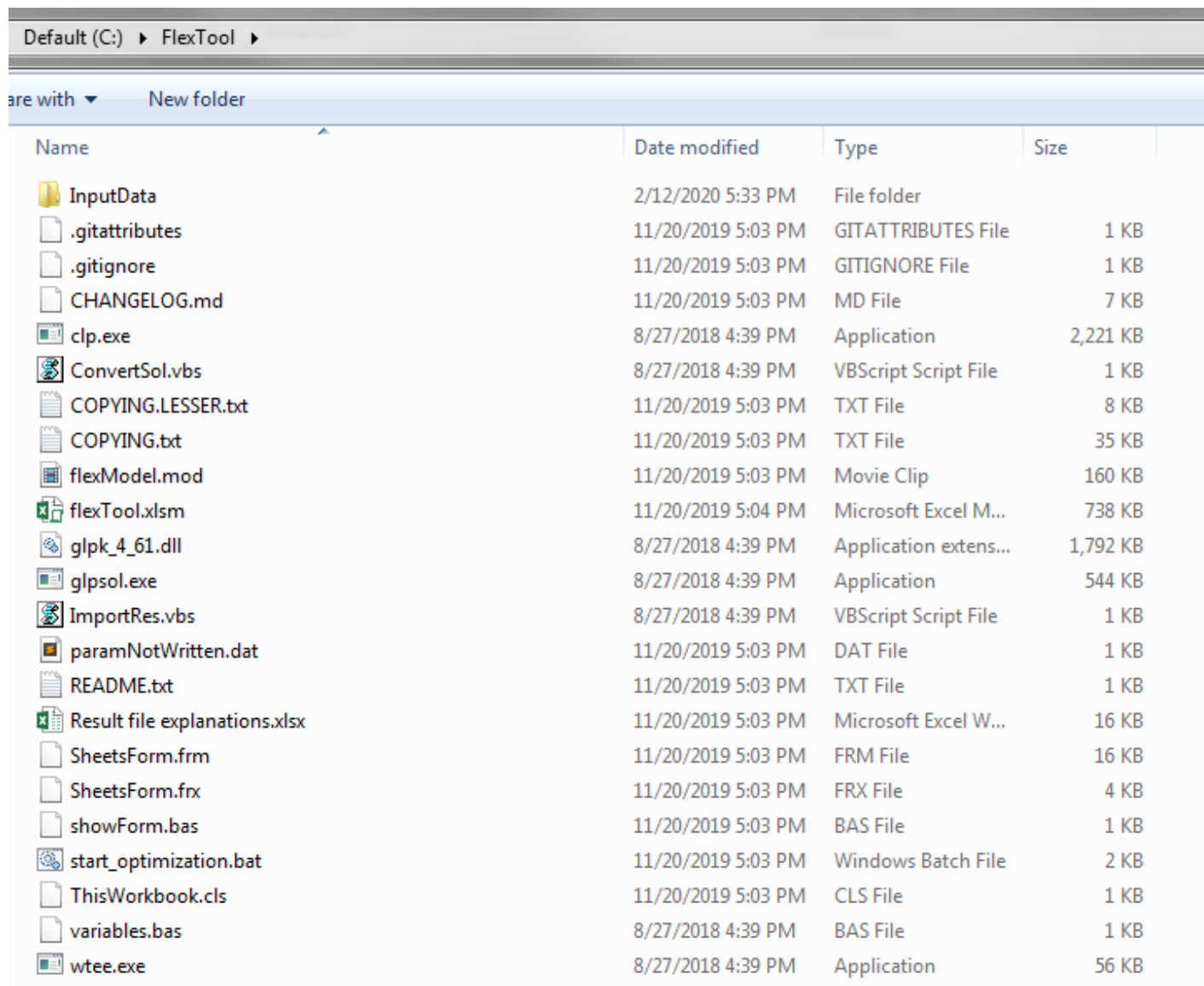

Name	Date modified	Type	Size
InputData	2/12/2020 5:33 PM	File folder	
.gitattributes	11/20/2019 5:03 PM	GITATTRIBUTES File	1 KB
.gitignore	11/20/2019 5:03 PM	GITIGNORE File	1 KB
CHANGELOG.md	11/20/2019 5:03 PM	MD File	7 KB
clp.exe	8/27/2018 4:39 PM	Application	2,221 KB
ConvertSol.vbs	8/27/2018 4:39 PM	VBScript Script File	1 KB
COPYING.LESSER.txt	11/20/2019 5:03 PM	TXT File	8 KB
COPYING.txt	11/20/2019 5:03 PM	TXT File	35 KB
flexModel.mod	11/20/2019 5:03 PM	Movie Clip	160 KB
flexTool.xlsm	11/20/2019 5:04 PM	Microsoft Excel M...	738 KB
glpk_4_61.dll	8/27/2018 4:39 PM	Application extens...	1,792 KB
glpsol.exe	8/27/2018 4:39 PM	Application	544 KB
ImportRes.vbs	8/27/2018 4:39 PM	VBScript Script File	1 KB
paramNotWritten.dat	11/20/2019 5:03 PM	DAT File	1 KB
README.txt	11/20/2019 5:03 PM	TXT File	1 KB
Result file explanations.xlsx	11/20/2019 5:03 PM	Microsoft Excel W...	16 KB
SheetsForm.frm	11/20/2019 5:03 PM	FRM File	16 KB
SheetsForm.frx	11/20/2019 5:03 PM	FRX File	4 KB
showForm.bas	11/20/2019 5:03 PM	BAS File	1 KB
start_optimization.bat	11/20/2019 5:03 PM	Windows Batch File	2 KB
ThisWorkbook.cls	11/20/2019 5:03 PM	CLS File	1 KB
variables.bas	8/27/2018 4:39 PM	BAS File	1 KB
wtee.exe	8/27/2018 4:39 PM	Application	56 KB

Enable macros, 1/3

1. Run flexTool.xlsm from root folder

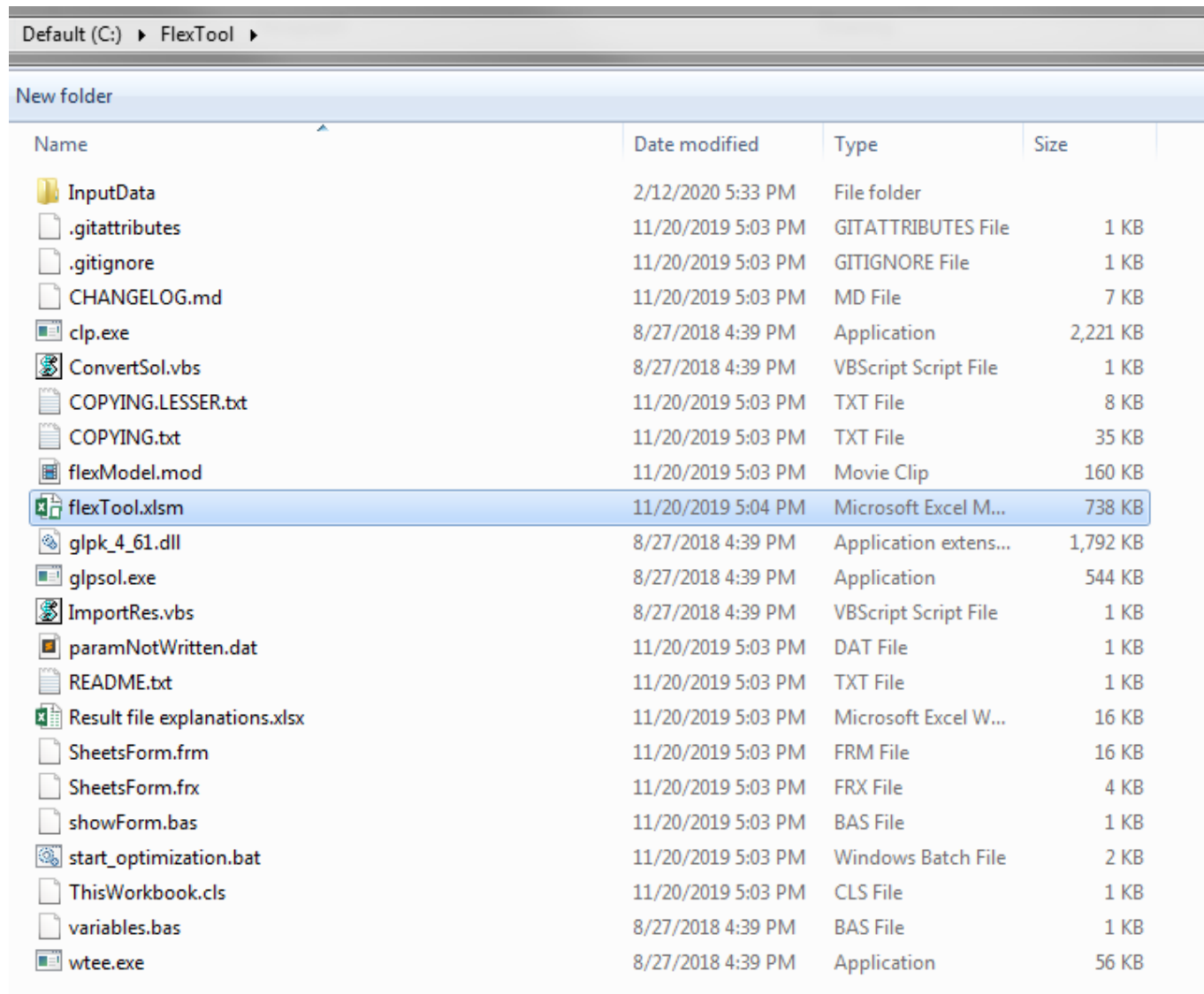

Default (C:) > FlexTool >

New folder

Name	Date modified	Type	Size
InputData	2/12/2020 5:33 PM	File folder	
.gitattributes	11/20/2019 5:03 PM	GITATTRIBUTES File	1 KB
.gitignore	11/20/2019 5:03 PM	GITIGNORE File	1 KB
CHANGELOG.md	11/20/2019 5:03 PM	MD File	7 KB
clp.exe	8/27/2018 4:39 PM	Application	2,221 KB
ConvertSol.vbs	8/27/2018 4:39 PM	VBScript Script File	1 KB
COPYING.LESSER.txt	11/20/2019 5:03 PM	TXT File	8 KB
COPYING.txt	11/20/2019 5:03 PM	TXT File	35 KB
flexModel.mod	11/20/2019 5:03 PM	Movie Clip	160 KB
flexTool.xlsm	11/20/2019 5:04 PM	Microsoft Excel M...	738 KB
glpk_4_61.dll	8/27/2018 4:39 PM	Application extens...	1,792 KB
glpsol.exe	8/27/2018 4:39 PM	Application	544 KB
ImportRes.vbs	8/27/2018 4:39 PM	VBScript Script File	1 KB
paramNotWritten.dat	11/20/2019 5:03 PM	DAT File	1 KB
README.txt	11/20/2019 5:03 PM	TXT File	1 KB
Result file explanations.xlsx	11/20/2019 5:03 PM	Microsoft Excel W...	16 KB
SheetsForm.frm	11/20/2019 5:03 PM	FRM File	16 KB
SheetsForm.frx	11/20/2019 5:03 PM	FRX File	4 KB
showForm.bas	11/20/2019 5:03 PM	BAS File	1 KB
start_optimization.bat	11/20/2019 5:03 PM	Windows Batch File	2 KB
ThisWorkbook.cls	11/20/2019 5:03 PM	CLS File	1 KB
variables.bas	8/27/2018 4:39 PM	BAS File	1 KB
wtee.exe	8/27/2018 4:39 PM	Application	56 KB

Enable macros, 2/3

2. Click "Yes" or "Enable Content"

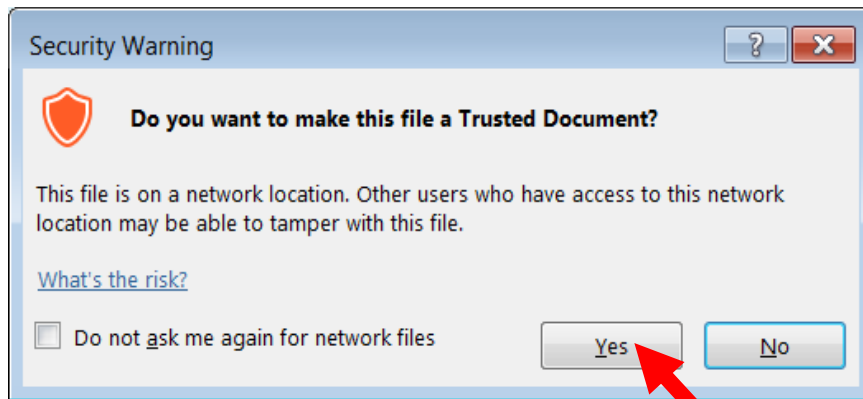

OR

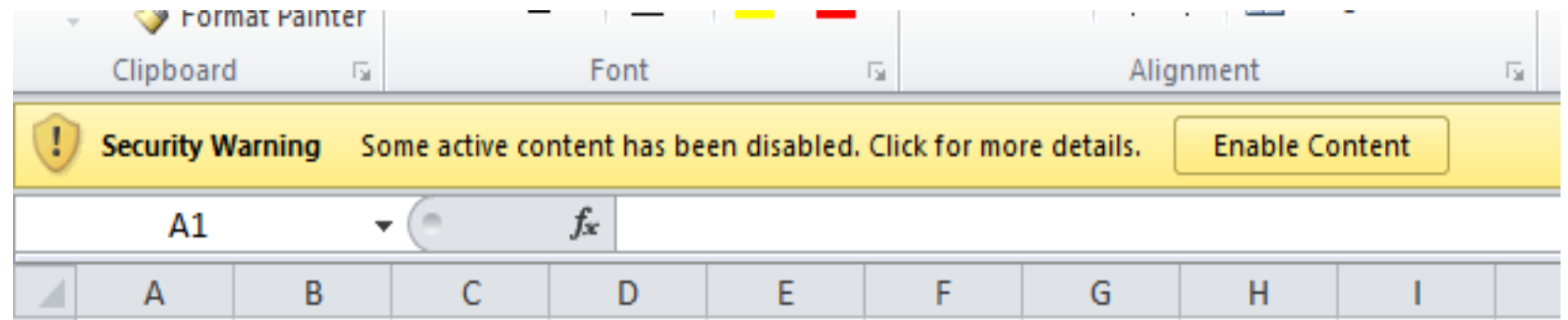

Enable macros, 3/3

3. In flexTool.xlsm

- a) Click "File", then
- b) "Options",
- c) "Trust Center",
- d) "Trust Center settings",
- e) "Macro settings" and make sure that "Trust access to the VBA project object model" is checked

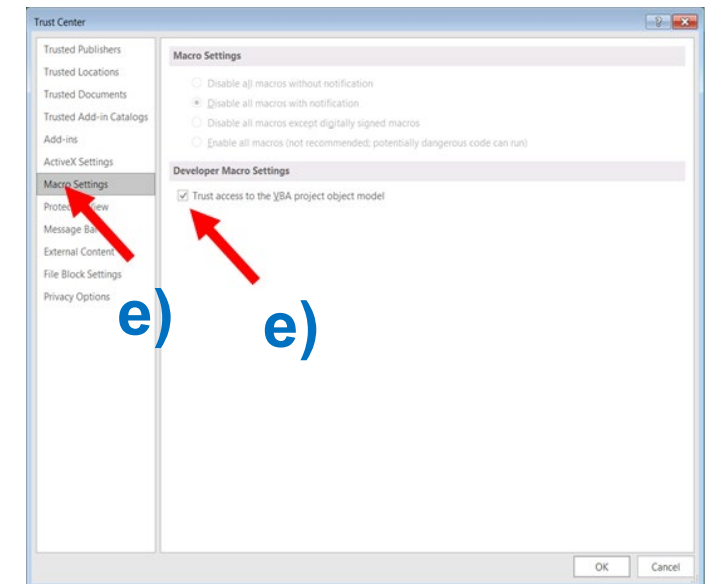
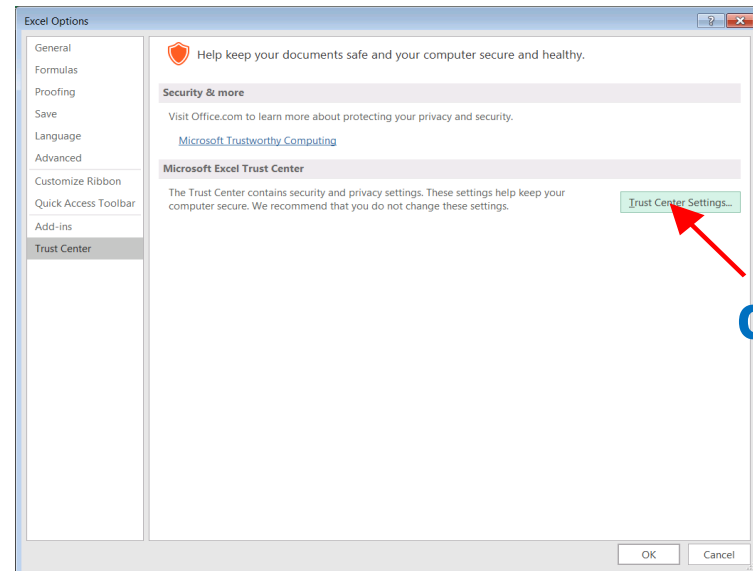
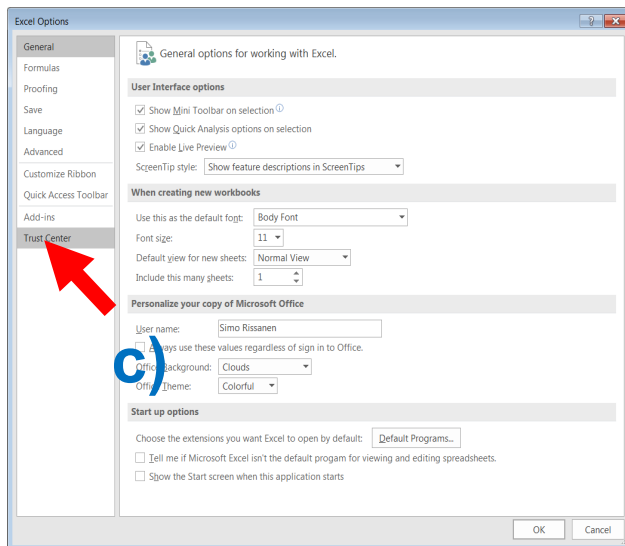
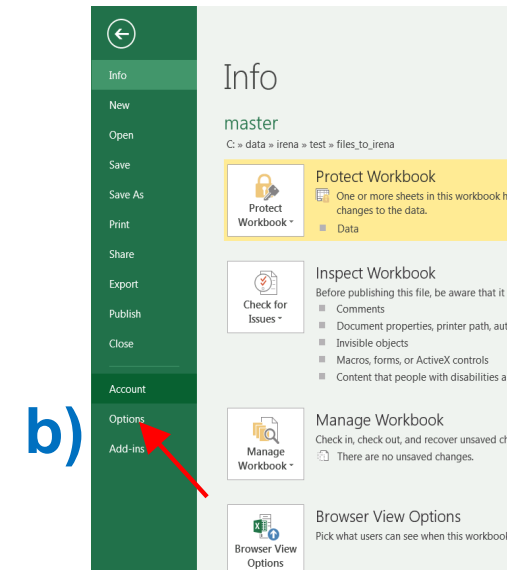
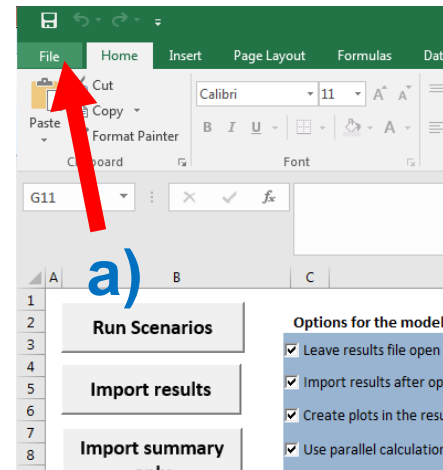







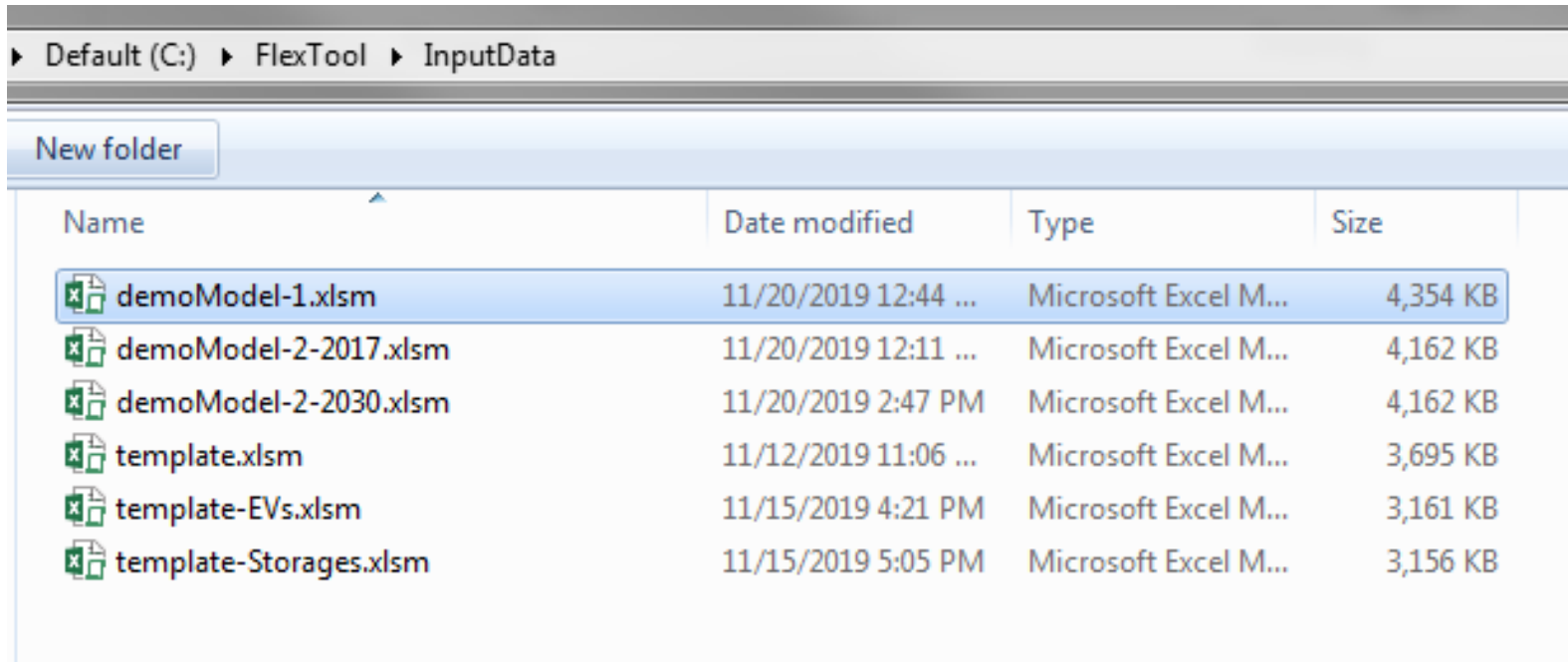

Run existing demo model, 1/4

1. Check from 'InputData' subfolder which files are included in the installation package.

- Template file is the default model and basis to create new models
- Template_XXX are additional examples on how to model specific technologies
- In addition, your installation package might contain other input data files (e.g., demo models or input data for your own country)



Name	Date modified	Type	Size
 demoModel-1.xlsm	11/20/2019 12:44 ...	Microsoft Excel M...	4,354 KB
 demoModel-2-2017.xlsm	11/20/2019 12:11 ...	Microsoft Excel M...	4,162 KB
 demoModel-2-2030.xlsm	11/20/2019 2:47 PM	Microsoft Excel M...	4,162 KB
 template.xlsm	11/12/2019 11:06 ...	Microsoft Excel M...	3,695 KB
 template-EVs.xlsm	11/15/2019 4:21 PM	Microsoft Excel M...	3,161 KB
 template-Storages.xlsm	11/15/2019 5:05 PM	Microsoft Excel M...	3,156 KB

Run existing demo model, 2/4

2. Open flexTool.xlsm

- a) Check from previous chapter that macros are enabled from two places

3. Open 'sensitivity scenarios' sheet.

- a) Click the first 'active input files' blue cell
- b) Choose 'template' input file from the pop-up window
- c) open the input file

The screenshot displays the FlexTool interface. On the left, a table lists 'Active input files' and 'Inactive input files'. The 'Active input files' table has a blue cell containing 'template.xlsm', which is circled in green and labeled '3a.'. The 'Inactive input files' table lists various template files like 'template-transmission.xlsm', 'template-storage.xlsm', etc. To the right, the 'Options for the modelling process' panel shows several checked options: 'Leave results file open after importing results', 'Import results after optimisation', 'Create plots in the results file', and 'Use parallel calculation'. An 'Open' file dialog window is overlaid on the right, showing a file explorer view of the 'FlexTool \> InputData' folder. The file 'template.xlsm' is selected and circled in green, labeled '3b.'. The 'Open' button in the dialog is also circled in green and labeled '3c.'. The dialog shows the file name 'template.xlsm' and the file type 'MS Excel (*.xls*)'.

- Only cases with same grids and nodes can
- Input files containing different energy syste

Run existing demo model, 3/4

4. Select active scenarios

- a) Check that only 'Base' is selected
- b) You can activate (list on left) or deactivate (list on right) scenarios with green arrows
- c) The list of inactive scenarios can be long, model does not run them unless activated
- d) You will later learn how to create your own scenarios

Active input files:	Inactive input files:
template.xlsm	<->
	<-> template-transmission.xlsm
	<-> template-storage.xlsm
	<-> template-EVs.xlsm
	<-> template-demandResponse.xlsm
	<-> template-CSP.xlsm
	<-> template-17520.xlsm
	<->
	<->
	<->
	<->
	<->

4a.

Active scenarios:	Inactive scenarios:
Base	<->
	<-> Invest
	<-> hydro-minus15p
	<-> hydro-plus15p
	<-> hydro-minus15p-invest
	<-> template_storageMW
	<-> template_storageFree
	<-> template_changeDemand
	<-> template_changeTransferC
	<-> Transmission
	<-> Gas engine

4b.

4c.

Run existing demo model, 4/4

5. Run demo model

- Click 'Write time series and Run Scenarios'
- Close the input file before running the model. The Flextool warns you if the input file is open.
- Wait and watch
- FlexTool automatically imports results file if the option is selected

5a.

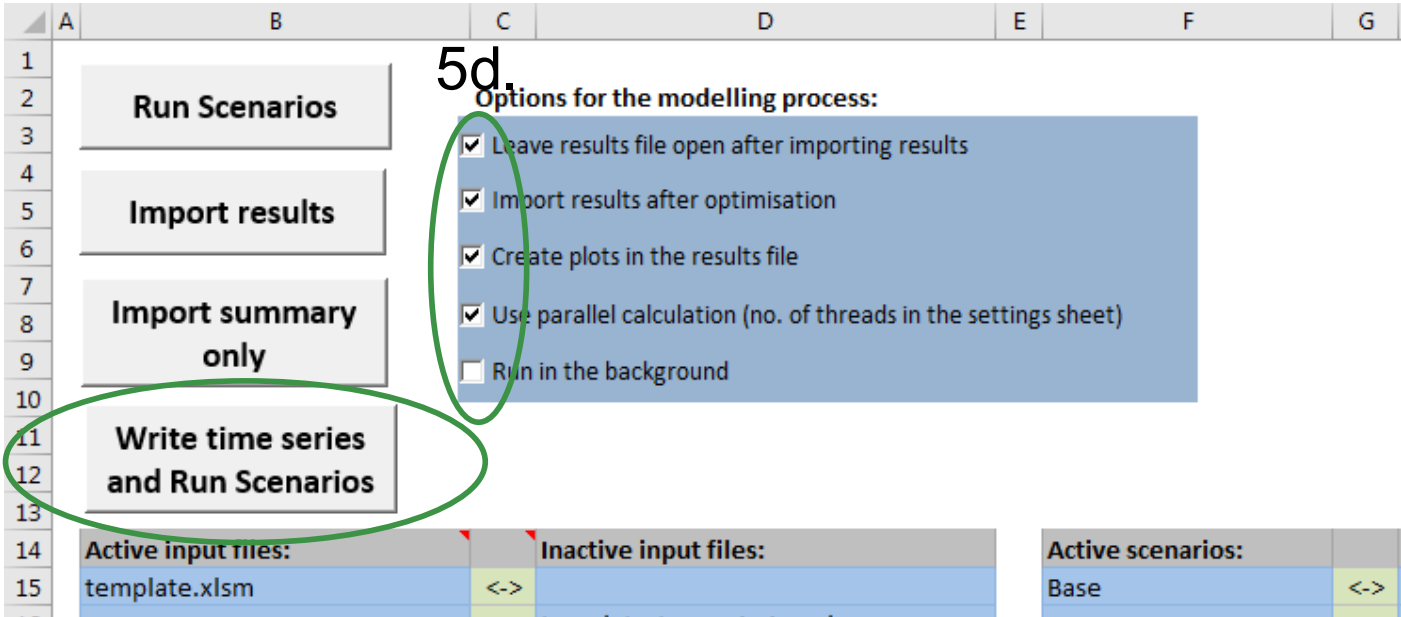

5d.

Options for the modelling process:

- Leave results file open after importing results
- Import results after optimisation
- Create plots in the results file
- Use parallel calculation (no. of threads in the settings sheet)
- Run in the background

Active input files:	Inactive input files:	Active scenarios:
template.xlsxm		Base

5c.

```
C:\WINDOWS\system32\cmd.exe
Total number of scenarios: 1
Scenarios started so far: 1
Scenarios not yet started: 0
Scenarios currently ongoing: 1
Scenarios failed: 0
Scenarios already finished: 0
```

Introduction to results file

6. Summary of results

- a) Shows most important results
- b) Open 'summary_D' sheet from results file
- c) Use the quick selection to find 'summary_D' sheet
- d) Run input data files and scenarios are shown at the top
- e) Summary result types are list at left side

	A	B	C	D	E	F	G	H
1	Update sheets window	template	template					
2		Base	Invest					
3	Optimal objective	6.44E+10	881881379.7					
4	Iterations	624	0					
5	Time (s)	0.412	0.312					
7	Total cost obj. function (M CUR)	64418.14324	860.0364647					
8	Time in use in years	0.018837643	0.019178082					
11	CO2 (Mt)	3.77309	5.93801					
13	General results	elec	elec					
14	VRE share (% of annual demand)	50.4	52.53					
15	Loss of load (% of demand)	18.05	0.06378					
16	Insufficient reserves (% of reserve demand)	0	0					
17	Insufficient inertia (% of inertia demand)	0	0					
18	Curtailement (% of VRE gen.)	4.263	0.0232					
21	Flexibility issues	elec	elec					
22	Loss of load (max MW)	1518.62	266.676					
23	Reserve inadequacy (max MW)	0	0					
24	Insufficient inertia (TWh/a)	0	0					
25	Curtailement (max MW)	661.513	36.2827					
26	Curtailement (TWh/a)	0.751842	0.00426613					
27	Model leakage (TWh/a)	-0.00492173	-0.000723485					
28	Capacity inadequacy (max MW)	0	0					
29	Spill (TWh/a)	52.7544	0					
31	Energy balance	elec	elec					
32	Demand (TWh)	-35.2083	-35.2083					
33	Consume (TWh)	-0.0910943	-0.01095					
34	Loss of load (TWh)	6.35591	0.0224563					
35	Generation, fuel based (TWh)	12.1592	15.0178					
36	Generation, VRE inc. river hydro (TWh)	17.6383	18.3859					
37	Discharge, inc. reserv. hydro (TWh)	0.752994	0.729219					
38	Charge (TWh)	-0.135782	-0.0324858					
39	Convert (TWh)	-1.4594	1.17352					
40	Import (TWh)	0.01	0.01					
41	Transfer losses (TWh)	-0.0218506	-0.0871419					
43	Costs	elec	elec					
44	Cost operations (M CUR)	771.272	789.287					
45	Cost investments (M CUR)	0	11.2479					

Labels in image:
6a: Points to 'summary_D' in the sidebar and the spreadsheet tab.
6b: Points to the 'OPERATIONS' category in the sidebar.
6c: Points to the 'template' and 'Invest' headers in the spreadsheet.
6d: Points to the 'Flexibility issues' section in the spreadsheet.



Batch run - Dispatch and Investment

7. It is easy to run many scenarios with FlexTool

- a) Select input files
- b) Select base and invest scenarios *
- c) Click 'Run Scenarios' or 'Write time series and Run Scenarios' **

The screenshot shows the FlexTool interface with the following elements:

- Options for the modelling process:** A panel with four checked options: 'Leave results file open after importing results', 'Import results after optimisation', 'Create plots in the results file', and 'Use parallel calculation (no. of threads in the settings sheet)'. There is an unchecked option 'Run in the background'.
- Buttons:** 'Run Scenarios' (circled in green), 'Import results', 'Import summary only', and 'Write time series and Run Scenarios' (circled in green).
- Active input files:** A table with one row: 'template.xlsx' (circled in green).
- Active scenarios:** A table with two rows: 'Base' and 'Invest' (both circled in green).

Active input files:	Inactive input files:	Active scenarios:	Inactive scenarios:
template.xlsx	<->	Base	<->
	<-> template-transmission.xlsxm	Invest	<->
	<-> template-storage.xlsxm		<-> hydro-minus15p
	<-> template-FV.xlsxm		<-> hydro-plus15p

FlexTool will run all combinations of selected input files and scenarios (e.g., 3 input files and 5 scenarios means $3 \times 5 = 15$ model runs)

Main features and assumptions, strengths and weaknesses of the tool

1. Selected assessment approach
2. Model output
3. How to define a FlexTool country-level model?
 - Main assumptions and methods
 - Input data requirements
 - Grids, nodes, units, and timesteps
 - User-given constraints
 - Scenarios
4. Strengths and weaknesses of the tool
5. Questions

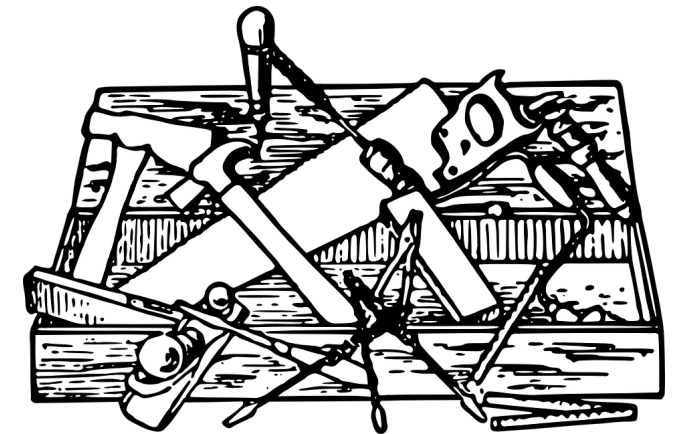

Selected assessment approach

Tier	Approach	Tools	Comments
Tier 1	Expert comparison	NREL System evaluation	Tier 1 tools are very simplified
	Visual comparison	GIVAR (IEA), Flexibility charts	
Tier 2	Ramp Evaluation	FAST2 (IEA), IRRE	Calculates system dispatch and resulting ramps. No capacity expansion or cost minimising capabilities
	Operational stochastics	InFLEXion	Post-processing tool. Uses results from a separate dispatch tool and historical variability and uncertainty to assess potential flexibility shortfalls.
	Flexibility check for/within planning tool	Flex Assessment, REFLEX	Pre-optimisation tool that requires a separate planning and unit commitment model. Assesses within-hour flexibility needs in the planning phase.
Tier 3	Reserve evaluation	FESTIV	Unit commitment, dispatch and reserve provision tool focusing on relatively short time scales. Does not perform capacity expansion, high level of expertise needed.
	Planning and operations	REFlex (proprietary), RESOLVE (not for sale), IRENA FlexTool (free tool)	Optimises future dispatch and/or portfolios (capacities, storages, demand response, etc) while considering operational constraints. RESOLVE and IRENA FlexTool can perform least-cost capacity expansion planning.



Model output, 1/2

- FlexTool produces a large range of **results**: flexibility indicators, unit dispatch, capacity expansion, costs, CO₂ emissions, etc.
- Interpretation of model output can be better if the user understands the **main features and assumptions of the model**.



Model output, 2/2

Output group	Main output types
Flexibility indicators	Loss of load, reserve shortages, spillage, VRE curtailment
Unit dispatch	Hourly dispatch of every unit
Transmission between nodes	Hourly use of transmission lines
Costs	OPEX: fuel costs, other O&M costs, CO2 costs, penalty costs from inflexibilities CAPEX: Generation capacity investments, transmission line investments, storage investments
Marginal prices	Hourly marginal price of electricity
Ramping information	One-hour and four-hour ramps
Investments	Invested amount, type, and costs for generation, transmission, and storages



FlexTool country-level model instance, 1/2

- Important to understand differences between
 - **Model FlexTool**, which is the same for all countries.
 - **Model instance**, where country-specific information is added to input data files and FlexTool Excel file (*e.g.*, FlexTool Thailand).
- Easy to
 - Share a model instance by copying only the input data
 - Make a new scenario by adding an alternative parameter value
- Typo in input data can crash the model!!
- It is important to be careful when double checking the input data
 - **Tip:** Create automated checks for the input data

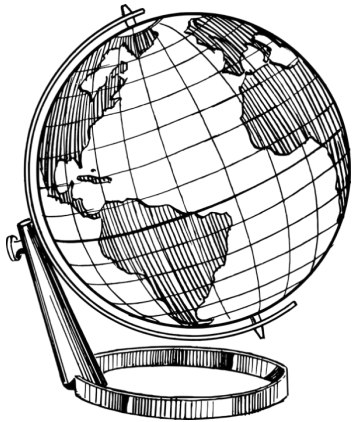



FlexTool country-level model instance, 2/2

- Follow steps to build a country-level model instance:
 - Download **the model** itself.
 - Create **input data files** that represent the country-specific data in FlexTool
 - Add **user-given parameters** that limit the model behavior based on laws, operations practices, etc. Required reserves, maximum VRE share, etc.
 - Add **scenario data** which are additional country-specific options, that can be turned on and off. Dry and wet years, investment runs, alternative runs with different capacity mixes, etc
- Main features and assumptions are presented here, more details in following sessions





Demand-supply balance, always

- The most important assumption of FlexTool is **demand and supply must always match**.
- User can change **length of time steps** (often 1 hour), but user cannot go around the energy balance
- This leads to many different **'what if' situations**
 - What if there is too little production? *Model produces 'loss of load energy' to balance the demand and supply*
 - What if there is more wind and solar than demand? *Model curtails part of the VRE production or uses storages to store extra energy*
 - What if there is some flexibility issue, e.g., consumption at west, production in east, and too little transmission capacity? *Model has to find a way to solve the situation, e.g., to invest new transmission lines (if investments are allowed) or produce 'loss of load' in west and 'curtailments' in east.*

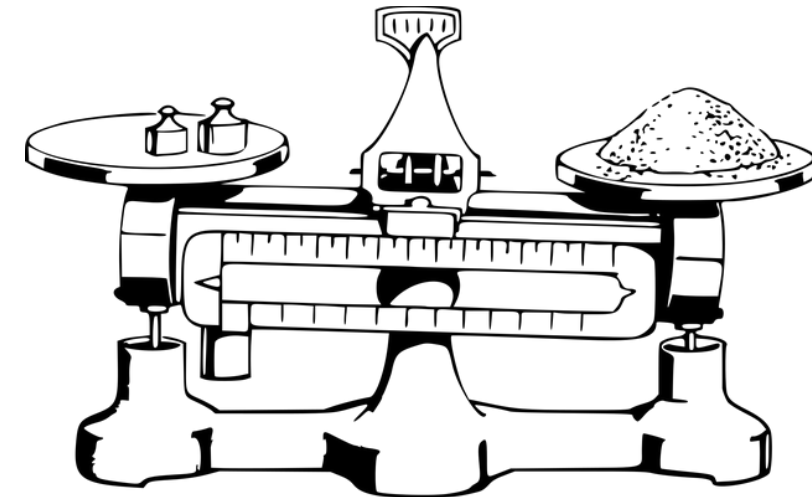



Linear optimisation

- FlexTool is a **linear optimisation** model
- **Optimisation** means, in this context, that the model **minimises total system costs**
 - Model makes all choices between different options by minimising total annual costs
 - However, model has to satisfy the energy balance and obey **constraints** (*e.g.*, generation from a unit plus reserve provision is less than the capacity of the unit)
 - Model finds the least cost solution given the assumptions
- **Linear** means, in this context, that everything can change between 0% and 100%
 - Linear models are very fast to solve
 - This allows us to include a large range of features in to the model
 - Linear models do not allow binary decisions (*e.g.*, on/off)
 - Users can still give constraints to a very large range of properties, *e.g.*,
 - how fast units can ramp,
 - what share of thermal units is required, etc





Input data requirements

Group	Main data types
Annual system data (annual, each node)	Electricity demand, imports, losses, and capacity margin
Electricity transmission data (each node)	Transmission and interconnection capacities
Generation capacity data (each node)	Installed capacity, technical data of units, hydro reservoir capacity
Time-series data (e.g., 8760 hourly values, each node)	Electricity demand, imports, hydro inflow, wind and solar generation
Fuel data (annual)	Fuel prices and emission rates



Grids, nodes, units, and timesteps

- FlexTool has **four basic building blocks**
 - **Grid (g):** One grid (g) for one product (*e.g.*, electricity).
 - **Node (n):** Each grid is localised to one or more nodes (n) (*e.g.*, electricity grid can be divided to three nodes - west, central, and east).
 - **Unit (u):** Units (u) can produce, consume and store from a node in a grid (*e.g.*, power plant produces electricity to the west node of the electricity grid). Units can also be used to convert energy between grids.
 - **Timestep (t):** Timesteps (t) are an ordered series of timesteps (*e.g.*, hours in a year)
- Together these form an abstract version of the modelled energy system (gnut-system)
- In FlexTool, input data defines the gnut-system
- The model itself is flexible and allows very different gnut-systems

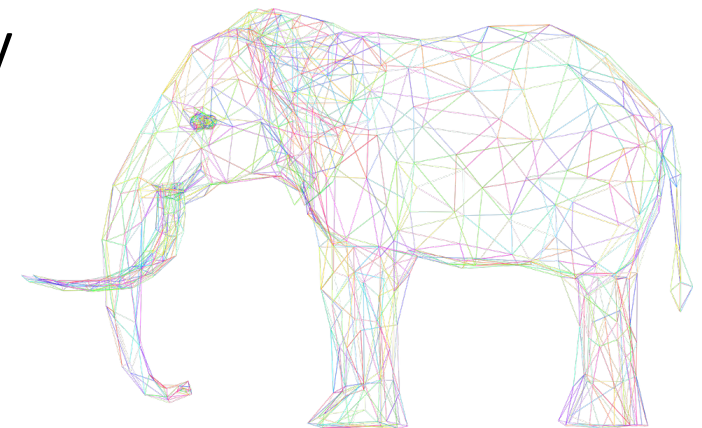



User-given parameters for the constraints

- In most cases the users want to give additional constraints that the model has to respect
- Typical constraints are
 - Minimum reserve capacity (MW at each timestep),
 - Maximum non synchronous share (% of the total generating capacity at each timestep),
 - Minimum inertia limit (MWs at each timestep),
 - Max ramp up/down rates for units,
 - Minimum up/down time of units,
 - Maximum/minimum invest on certain technology
 - Fixed generation of certain unit
- Parameters that control the constraints need to reflect reality
 - Too loose constraints can give too optimistic (unrealistic) solutions
 - Too strict constraints can lead to too limited (unrealistic) solutions

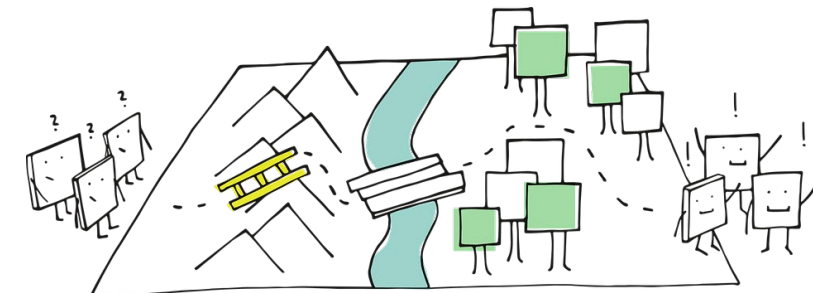



Example of nodes, units, and possible constraints

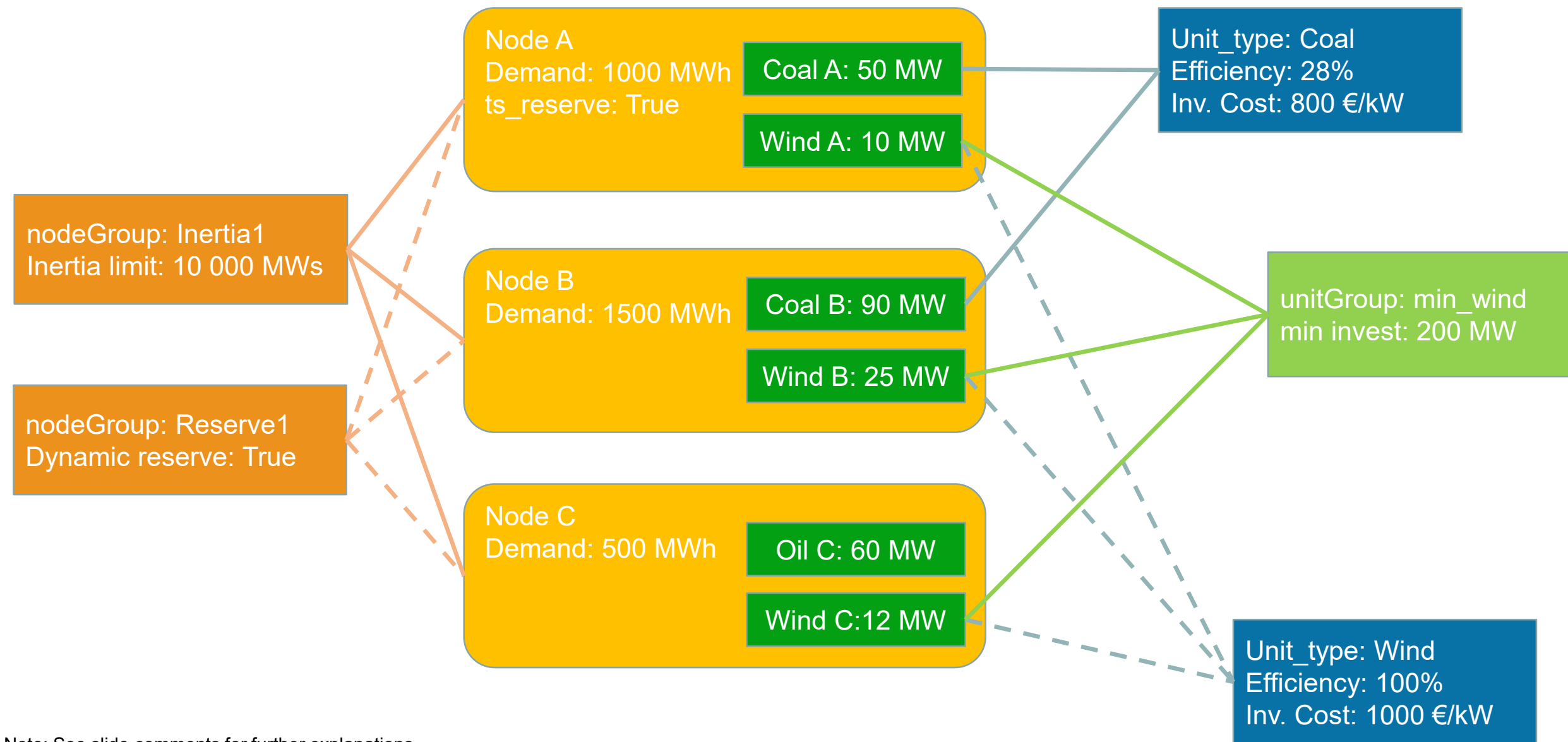



FlexTool has two operation modes

- **Dispatch:** FlexTool optimises the operation of predefined capacity. Dispatch mode is used to study *e.g.*,
 - Flexibility issues in the current situation and existing capacity expansion plans.
 - CO₂ reductions resulting from the capacity expansion plan.
- **Invest:** FlexTool can invest to new capacity to solve flexibility issues or to reduce operation costs
 - User limits the amount of allowed investments by defining maximum investments for capacities and by adding modelling constraints, *e.g.*, maximum non-synchronous share

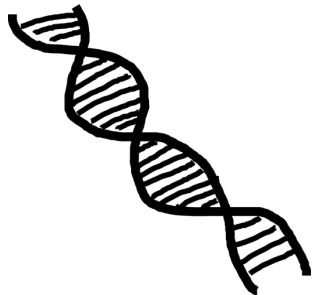



Perfect foresight

- FlexTool has a **perfect foresight**, because it solves the whole gnut-system at one go.
- However, the solution is as good as the input data – **garbage in, garbage out**
- Perfect foresight means that the model can use all information given to model at every timestep
 - *E.g.*, if input data says that the autumn will be very dry and hydropower produces only little, the model knows it already in the spring.
 - Real life operations have a large number of uncertainties and forecast errors that can be included in more complicated models
- However, FlexTool accounts a part of the uncertainty by dedicating a share of the capacity as reserves

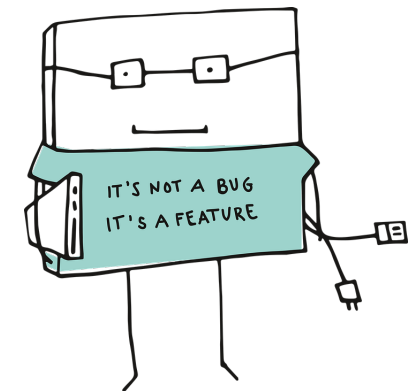



Storages

- In FlexTool, **storage units** are special units that can store energy and release it later.
 - The basic uses, *e.g.*, battery storages, are very simple to model with FlexTool
 - More advanced case studies can have **storage charging units** that store energy in to a **storage grid** and **storage discharge units** that convert stored energy back to the default grid. This allows *e.g.*, different input/output powers.
 - Different modelling techniques allows many different kind of storages (*e.g.*, batteries, pumped hydro, power-to-x, etc)
 - Users can study how storages benefit the energy systems in a short and long term

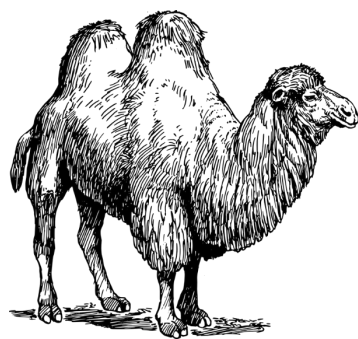



Sector coupling

- FlexTool can model **sector coupling** in many different approaches, *e.g.*
 - ‘**Dummy EV charging**’ where car owners just charge their cars and don’t care about the grid
 - ‘**Smart EV charging**’ where a certain share of EV owners can shift their charging times by few hours depending on the grid situation
 - ‘**EVs as storages**’ where a certain share of car owners allow their car batteries to be used as balancing storages in the grid, often called V2G

- Possible to model just one of these cases or a mixture of all cases





- Allow user to
 - Make quick small changes that **do not change** the baseline input data
 - Run many variations and/or sensitivities easily
- Use them to
 - Run **sensitivity analysis**, *e.g.*, vary annual electricity demand $\pm 10\%$
 - Make changes to parameters, *e.g.*, changing amount of wind, solar, and storages
 - Change **operation mode** of the model, *e.g.*, dispatch and investment
 - Study the impact of the **parameters** that control the constraints
- Are not designed to
 - Change a large set of parameters (*e.g.*, time series)
 - Change the modelled year, *e.g.*, 2017 and 2030 need separate input files

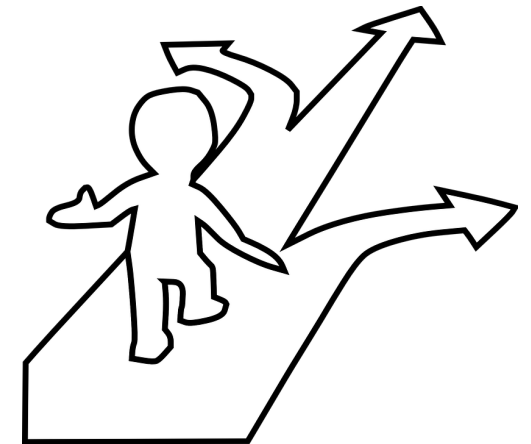



Strengths and weaknesses

Strengths

- Free, open source, and relatively simple to use
- Optimised full year dispatch runs at hourly or sub-hourly resolution
- Highlights possible operational problems and costs arising from insufficient flexibility
- Capable for investment scenarios to study least cost solutions for flexibility issues and long-term capacity expansion planning
- Capable for integrated modelling of storages, sector coupling, unit level constraints, etc

Weaknesses

- Linear model; cannot model binary decisions
- Deterministic model; does not have forecast errors *
- Simplified power transmission: transport model
- Simplified reserve modelling

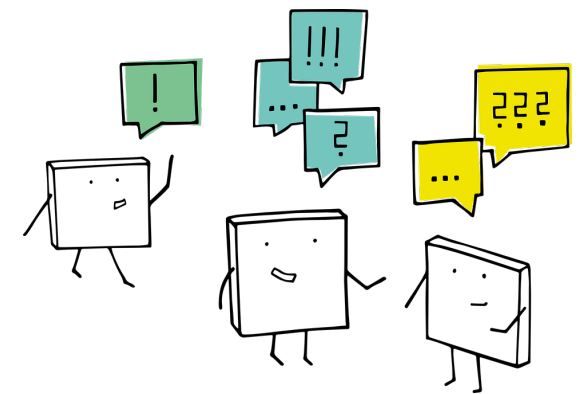

* Apart from what is accounted for in the reserves

Designing a FlexTool flexibility assessment



Example from case study with Thailand

1. Model design

- Grid
- Capacity expansion plan
- Other lessons from operation practices
- Status of flexibility enablers

2. Highlights from analysis

- Dispatch in 2036
- Flexibility in 2036
- Evaluating additional investments

1. Connections with neighboring countries

- Long-term contracts with hydro power operators in Laos
- Plans to expand hydro power in Laos and Myanmar
- Otherwise weak connections

2. Internal grid

- Long country with uneven demand and production
- Hydro power at north
- Bangkok consumes much more than produces
- However, not enough regional data available

3. Modelling decisions

- Model Thailand as one node (main thing to improve)
- Included contracted hydro power plants in Laos and Myanmar as a part of the Thailand model

Figure 3: Thailand's transmission network



Disclaimer: Boundaries and names shown on this map do not imply any official endorsement or acceptance by IRENA.

Capacity expansion plan

1. Fast growth in electricity demand

2. Current capacity expansion plans (“Reference”)

- To meet demand by adding fossil fuel generation capacity
- Invest to relatively small share of wind and solar (5% of annual demand at 2036)
- Build several GW of pumped hydro capacity

3. In one node model

- No capacity adequacy issues expected (*strong capacity balance*)
- No ramping capacity issues expected (*hydro reservoirs + NGCCs*),
- No curtailments expected (*low VRE share + hydro reservoirs + pumped hydro*)
- but additional VRE capacity could be cheaper option than new fossil based generation?

Figure 2: Expected evolution of Thailand’s generation capacity mix, 2015-2036

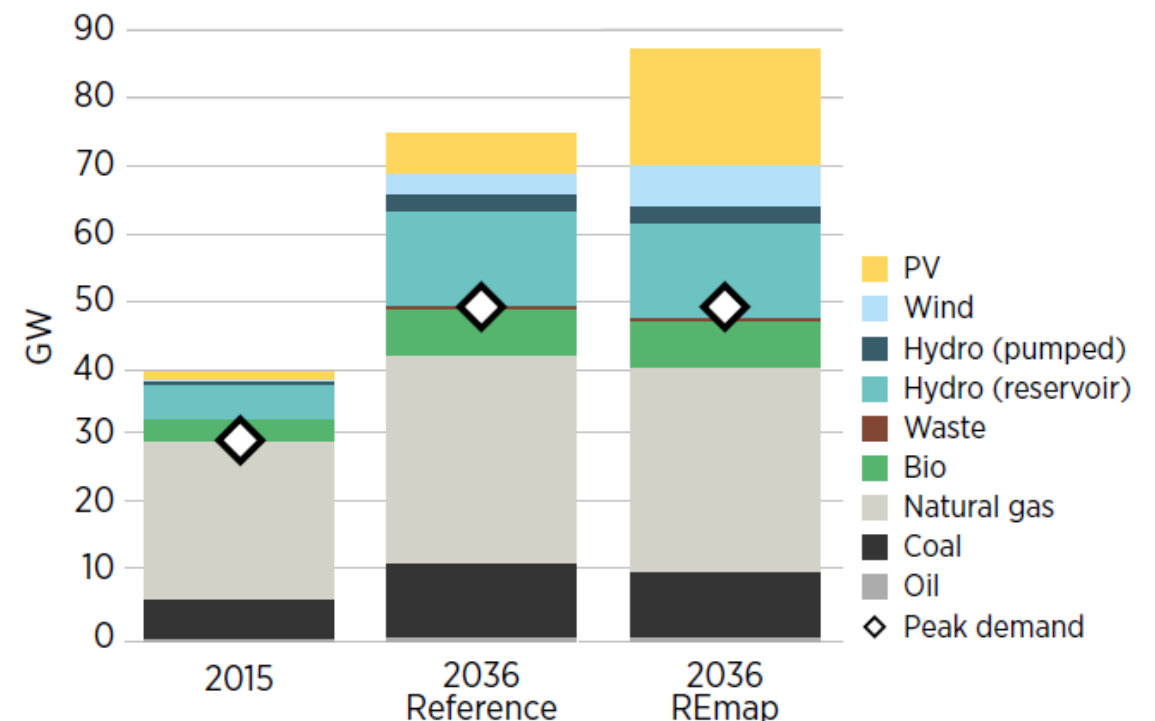

Note: “2036 Reference” refers to the expected capacity mix based on existing plans and policies.



Other lessons from operation practices

1. Thailand has **peak electricity demand after the sunset**
 - Solar PV cannot contribute directly to peak power
 - Storages needed → Thailand has decided to invest in reservoir hydro and pumped hydro
2. **Hydro inflow variance** between years can cause some issues
 - The variations between years are not exceptionally large in Thailand, but dry years need to be simulated
3. **Geographical dispersion of VRE** cannot be analyzed with one node model
4. **Strength of internal grid** cannot be analyzed with one node model
5. Thailand had data in **30 minute intervals** and the model was built with 30 minute time steps to pay additional attention to ramp rates

Flexibility enablers in Thailand's power system

Flexibility enablers	High	Medium	Low
Interconnection capacity vs. average demand			●
Generator ramping capabilities	●		
Matching of demand with VRE generation		●	
Hydro inflow stability		●	
Strength of internal grid		N/A	
Storage vs. annual demand		●	
Geographical dispersion of VRE generation and demand		N/A	
Minimum demand vs. VRE capacity	●		

Dispatch in 2036

Power generation (annual share) and hourly dispatch over a week in 2036 with the highest VRE penetration: Reference and REmap scenarios

2036 Reference

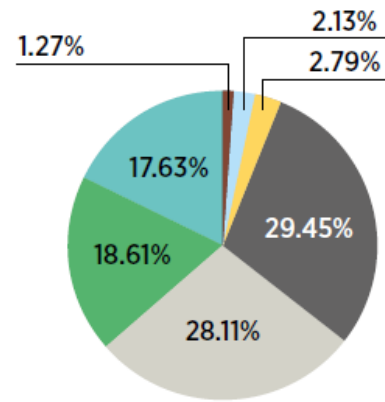

2036 REmap

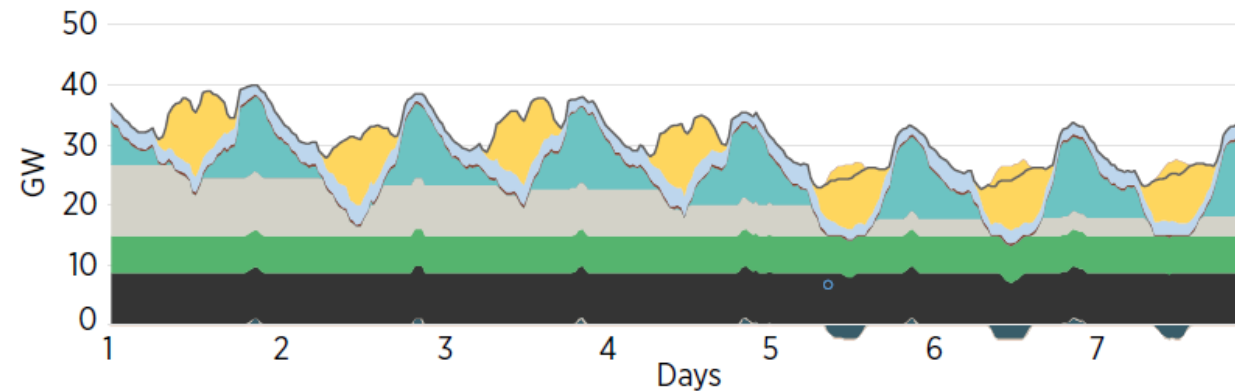
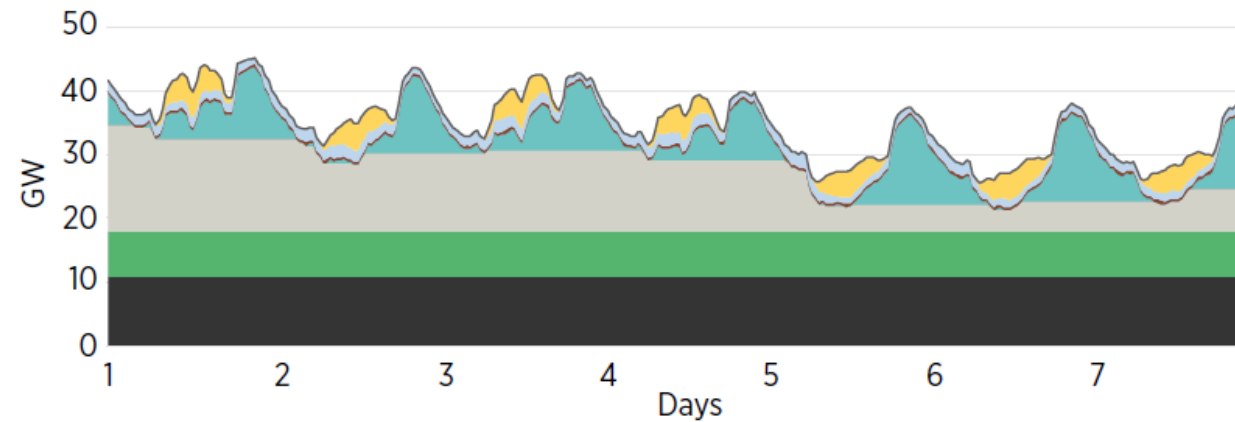
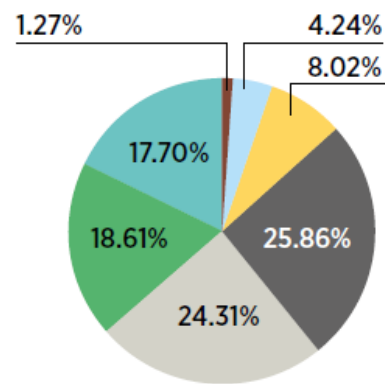



Flexibility in 2036

**Main flexibility indicators for Thailand's power system in 2036 reference and REmap scenarios:
No flexibility issues identified**

	2036 Reference		2036 REmap	
	Total (GWh)	Peak (MW)	Total (GWh)	Peak (MW)
Curtailment	0	0	0	0
Loss of load	0	0	0	0
Spillage	0	0	0	0
Reserves inadequacy	0	0	0	0



Evaluating additional investments

Additional investments to wind and solar power could save more than 2000 million USD per year for Thailand, including investment costs.

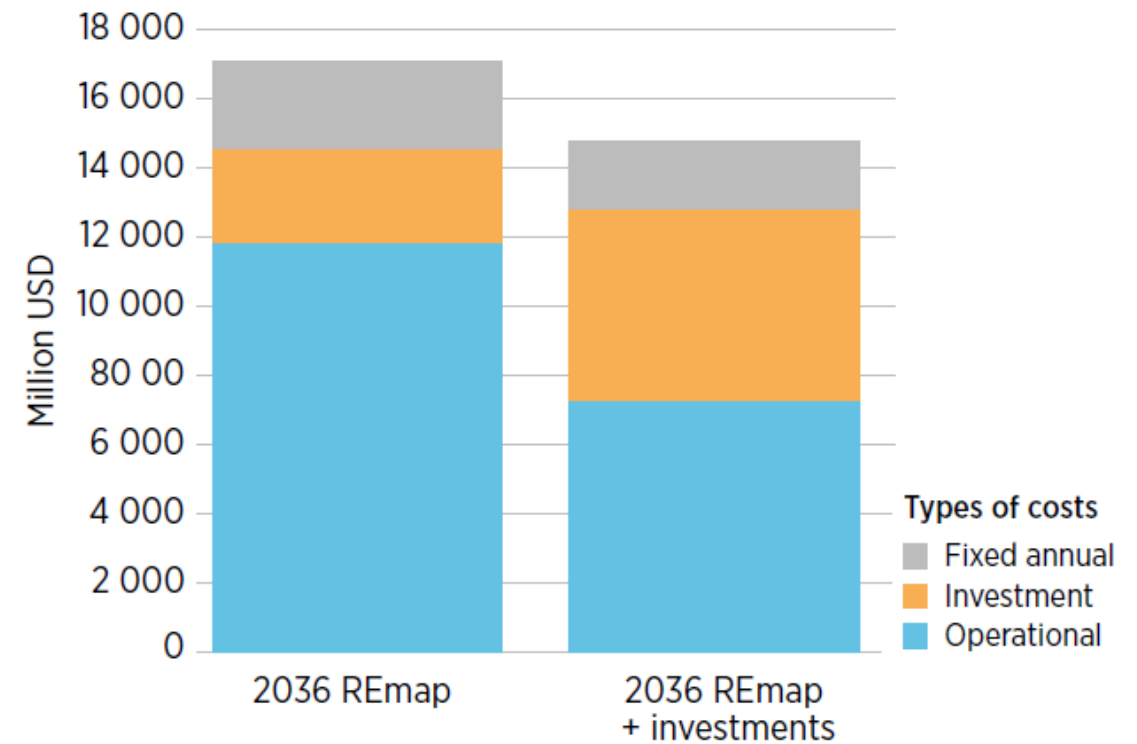
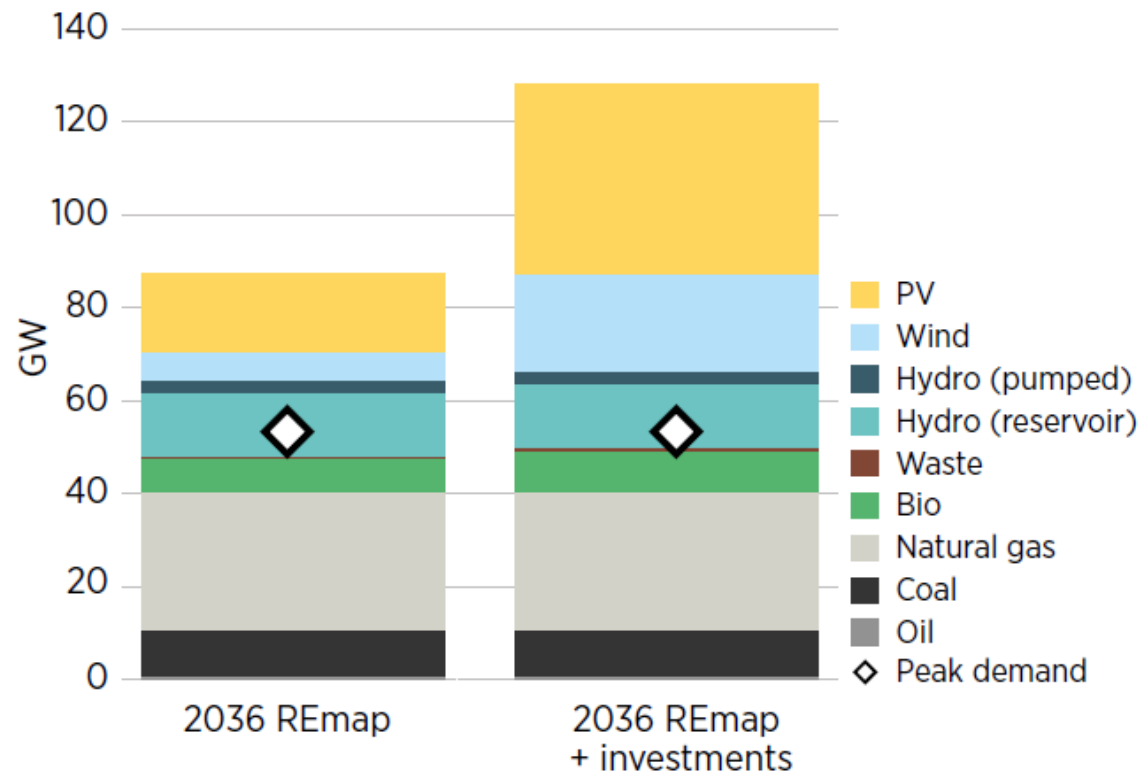



Operational experience

- **Experience** on current situation is extremely valuable
 - Many problems are already known
 - Some solutions are already under construction
- **Model details** have to be designed to answer questions of interest



Preparing to create your own input data files

- When preparing input data files, modellers need to decide the **structure of the model** (amount of nodes, modelled technologies, etc)
- The **amount of details** affect needed data. For example, multinode models needs considerably more data than single-node model.
- Table on right shows the data needed for input data files
 - All data for both base year and future year(s)

Table 9: Summary of data needed for a FlexTool case study

System data (annual, each node)	
Annual demand (GWh)	needed
Annual imports (GWh)	needed
Losses (GWh)	if available
Capacity margin (MW or %)	if available
Max. non-synchronous share (% of VRE generation + high-voltage direct current imports in one hour)	optional
Electricity transmission (each node)	
Interconnector capacity with other countries (MW)	needed
Transmission capacity between nodes (MW)*	needed
Max. investment in transmission – separate values for each couple of nodes	optional
Data of generation capacity (each node)	
Existing capacity by fuel/technology (MW)	needed
Details of capacity by fuel (efficiency, O&M cost, etc.)	if available
Generation by fuel/technology (GWh)	needed
Hydro reservoir capacity (GWh)	needed
Decided/planned investments 2015 -> 2030	needed
Max. limit of certain investment	optional
Time-series data (8 760 hourly values, each node)	
Electricity demand (MW in each hour)	needed
Hydro inflow (GWh)	needed
Wind generation	needed
Solar generation	needed
Electricity imports (for the nodes with cross-border interconnection)	needed
Fuel data	
Fuel cost	needed

Introducing demo models for training

Demo models of an imagined country to demonstrate the most important features of IRENA FlexTool

- The basic structure is the same for each demo model
- Each demo model is designed to have specific flexibility issues
- Training participants are instructed to assess and solve these

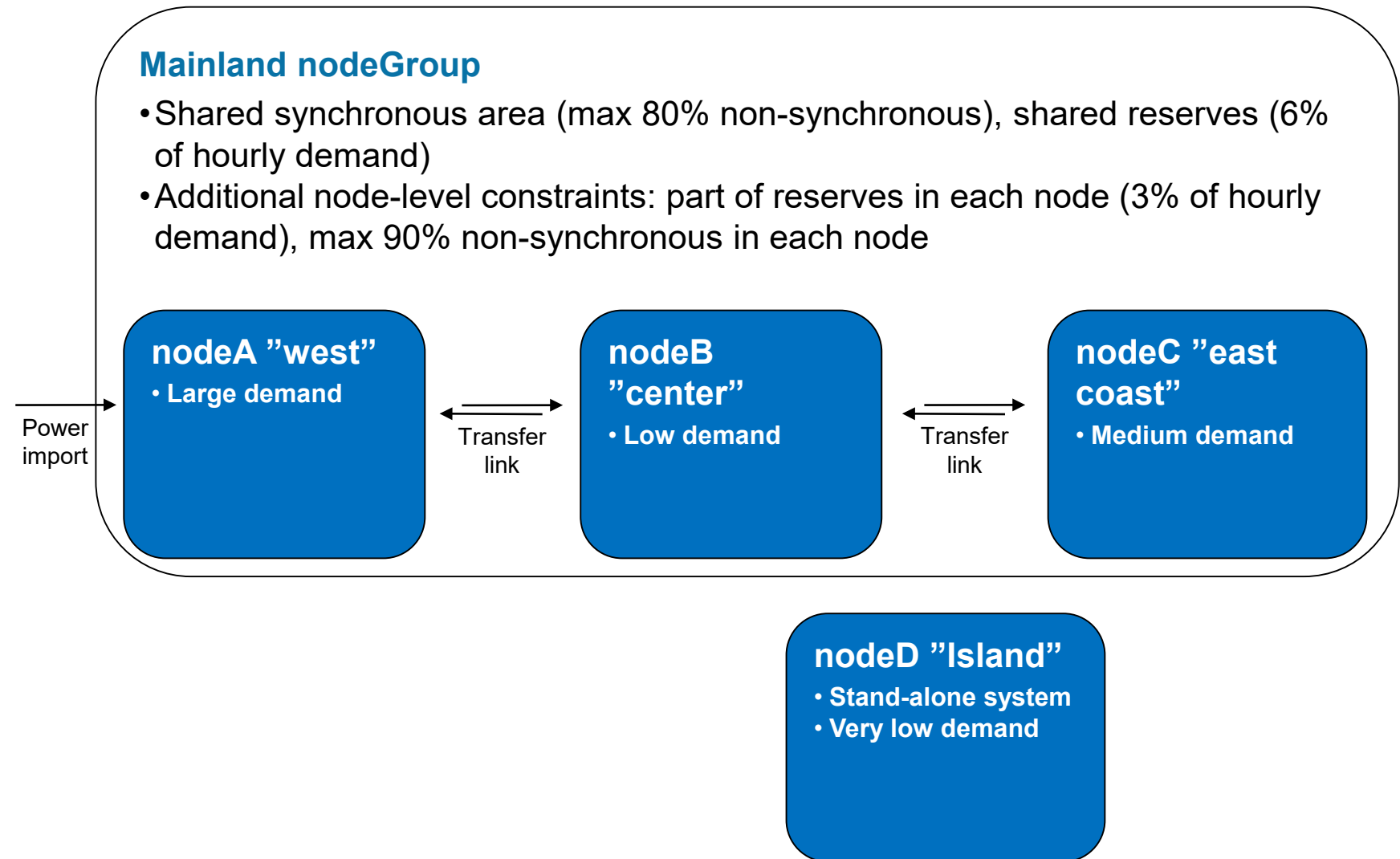



Model solve time

- Increasing **complexity** quickly increases model **solving time**
 - 4 nodes
 - Hydro storages
 - Investment run
- Good flow in training requires very quick solving times
 - Thus, very few hours are modelled (4 week dispatch, 4 day invest)
 - In practice, it is recommended to use shorter time series for testing and longer or full year for actual modelling
- In addition, some time goes to writing the data and results

Number of modelled hours	Dispatch	Invest + Dispatch
24 (1 day)	1 sec	2 sec
72 (3 days)	2 sec	15 sec
168 (1 week)	5 sec	1.5 min
672 (4 weeks)	20 sec	...
...



Running flexibility assessments with demo models – Demo model 1

Demo model 1

Open 'inputData\demoModel- 1.xlsm'

- Check “units” sheet
- Model has mostly fossil fuel based generation,
- Some hydro power in nodeB, wind power in nodeC, and small shares of PV and biomass in most nodes.

Mainland nodeGroup

- Shared synchronous area (max 80% non synchronous), shared reserves (6% of hourly demand)
- Additional node-level constraints: part of reserves in each node (3% of hourly demand), max 90% non-synchronous in each node

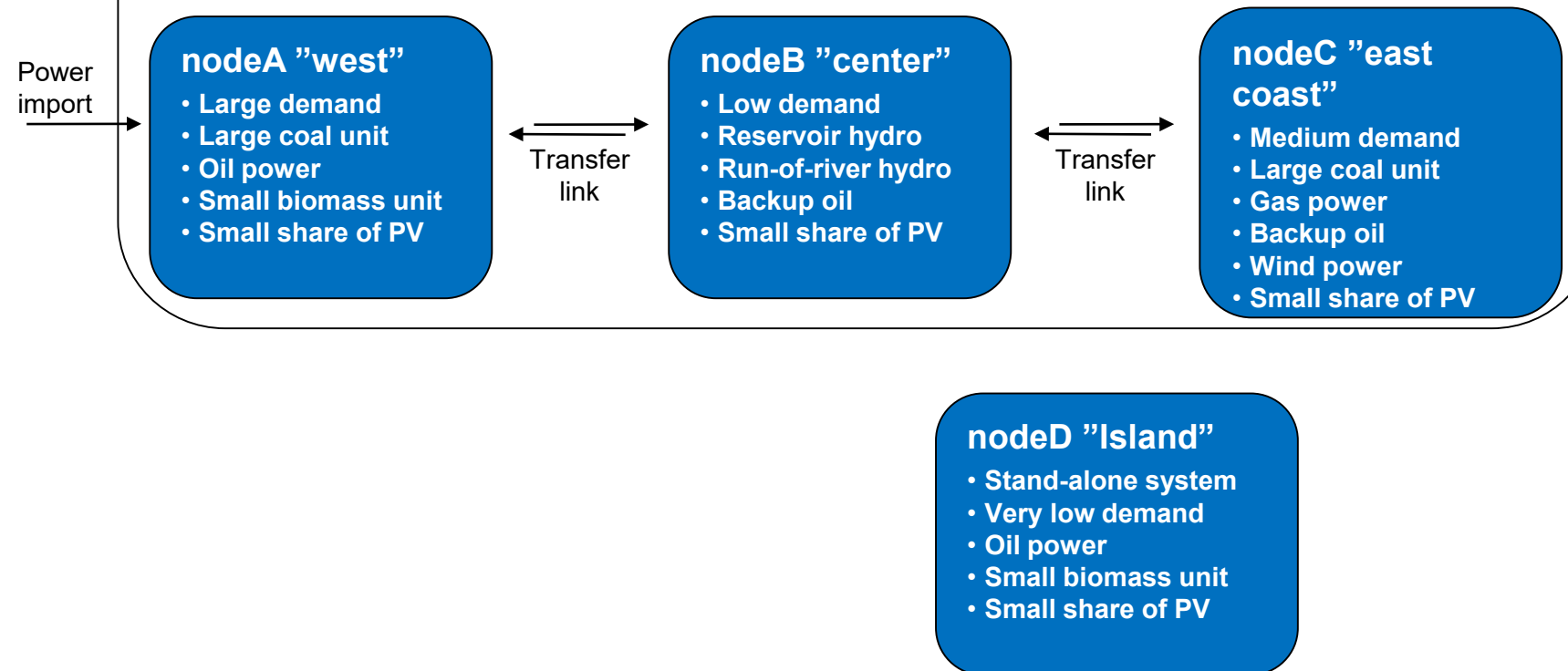



Demo model 1

Try running the Base run of the demo model 1

- Just testing that it works for everyone

Our initial assessment of the flexibility enablers on the demo model 1 is presented on right

Go through the following slides to see if you agree or will have different conclusions

Flexibility enablers in the demo model 1

Flexibility enablers	High	Medium	Low
Interconnection capacity vs. average demand			●
Generator ramping capabilities	●		
Matching of demand with VRE generation		●	
Hydro inflow stability		●	
Strength of internal grid			●
Storage vs. annual demand			●
Geographical dispersion of VRE generation and demand			●
Minimum demand vs. VRE capacity	●		

Quick check of flexibility issues

- Import results from the Base run of demo model 1.
 - See instructions from day 1 presentation if needed
 - Check **General results** and **Flexibility issues** from **Summary_D**
- Notable loss of load, need to find out where and why
- Very minor curtailments, not a real issue
- No other flexibility issues

Some lines are explained next to the number.

Open result file explanations to see definition for the rest

	A	B
1	Update sheets window	demoModel-1
2		Base
20		
21	General results	elec
22	VRE share (% of annual demand)	8.554
23	Loss of load (% of annual demand)	2.368
24	-> ramp up constrained (% of annual demand)	0
25	Excess load (% of annual demand)	0
26	Insufficient reserves (% of reserve demand)	0
27	Insufficient inertia (% of inertia demand)	
28	Curtailment (% of VRE gen.)	-6.66E-06
29	-> ramp down constrained (% of VRE gen.)	0
30	Peak load (MW)	2101.55
31	Peak net load (MW)	1946.3
32		
33	Flexibility issues	elec
34	Loss of load (max MW)	255.475
35	Excess load (max MW)	0
36	Reserve inadequacy (max MW)	0
37	Insufficient inertia (TWh/a)	0
38	Curtailment (max MW)	0.000137541
39	Curtailment (TWh/a)	-7.48E-08
40	Model leakage (TWh/a)	0
41	Capacity inadequacy (max MW)	0
42	Spill (TWh/a)	0



Loss of load, 1/2

Checking total capacity balance to find the reason for loss of load

- Possible to do prior to model, from input data or results file
- Here checked from the results file
- Open results file of Base run
 - **Summary_D** shows peak demand, capacity, and generation (figures at right)
- Peak load is less than dispatchable capacity. Peak net load even less. Country level sum is ok, no problems here.
- Problems must arise from certain node or nodes

Demo model 1, sum of all nodes

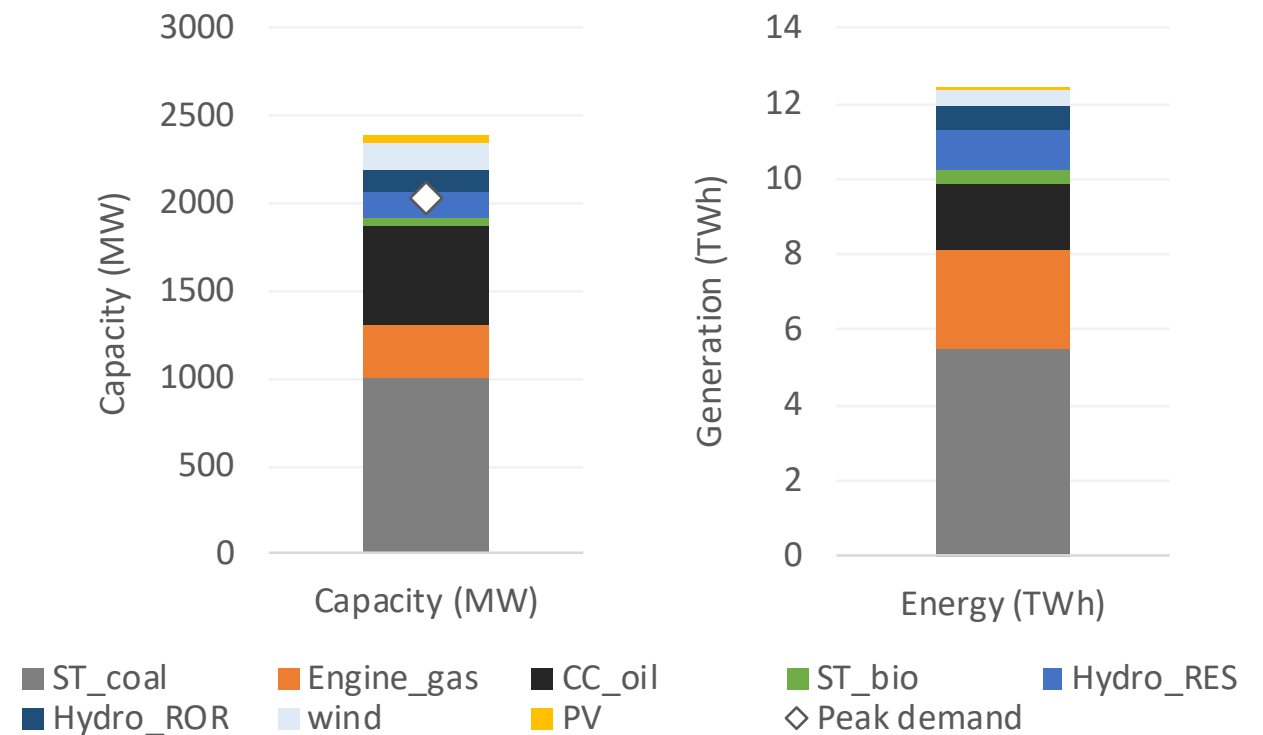

To check node level results

- Open “**node_plot**” sheet from the results file
 - The first figure shows that loss of load is from nodeA
 - The second and third figure on the second row show that nodeC transfers electricity to nodeA
- The conclusion is there would be enough generation capacity (previous slide) but it is not where demand is and/or there is not enough transmission capacity
- Possible solutions:
 - investing to transmission capacity,
 - investing to generation capacity,
 - investing to storages
- Need to check benefits and costs of each option

Load shedding

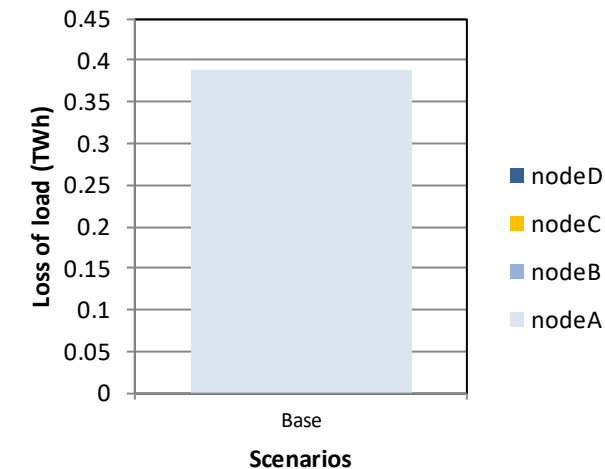

Transfers to the node

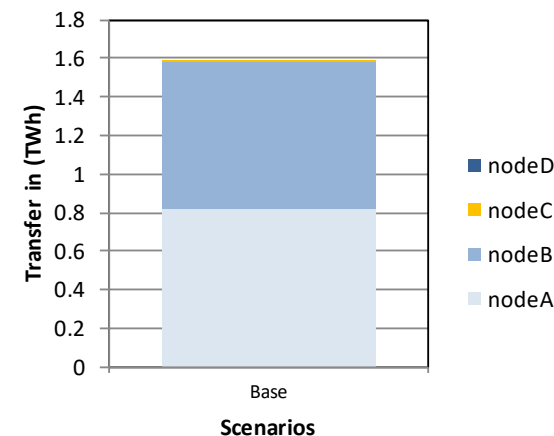

Transfers out of the node

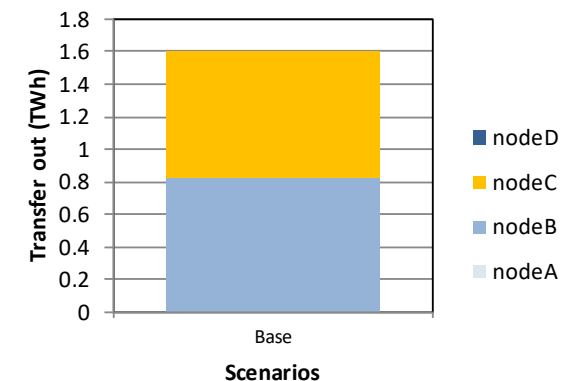



Comparing different investment options, 1/9

- We want to study how the **loss of load issue** could be fixed
- We want to study **three different measures**:
 - Investing in transmission capacity
 - Investing in generation capacity
 - Investing in storages
- In addition, we want to **compare these options** and see if they would better alone or together
 - Fourth investment scenario: investing to all three groups

Comparing different investment options, 2/9

Open flexTool.xlsm

- From 'settings and filters' sheet, set max number of parallel calculation = 3 (or number of cores -1)
- Select demoModel1 and 5 scenarios as in figure
- Click '**write time series and run model**'
- Wait until result file opens
 - Sometimes the result file fails to open, and does not show numbers. In this case, close the file, go to folder **results**, and open the most recent file.

	A	B	C
1			
2	Parameter	value1	valu
3	Node filter (leave out):		
4	Grid filter (leave out):		
5	Time series filter:	ts_time	ts_e
6	Model file:	flexmodel.mod	
7	Solver:	CLP	
8	CLP solver option:	barr	
9	Clear result folder:	TRUE	
10	Use wtee:	TRUE	
11	Max number of parallel calculations:	3	
12	Input folder:	inputdata	
13	Time series folder:	ts	
14	Results folder:	Results	
15	Plot start time:	1	
16	Plot length:	168	
17			

a

Active input files:	Inactive input files:	Active scenarios:	Inactive scenarios:
demoModel-1.xlsm	template.xlsm	Base	Invest
		demo1_invest_transCap	
		demo1_invest_genCap	
	template-transmission.xlsm	demo1_invest_storages	
	template-storage.xlsm	demo1_invest_all	
	template-FVs.xlsm		

b

Write time series and Run Scenarios

c

```
C:\WINDOWS\system32\cmd.exe
Total number of scenarios: 5
Scenarios started so far: 2
Scenarios not yet started: 3
Scenarios currently ongoing: 2
Scenarios failed: 0
Scenarios already finished: 0
Maximum number of cases ongoing
```

d

Comparing different investment options, 3/9

In results file

a) Open **summary_D** sheet

b) Check **General results** and **Flexibility issues** tables

- Transfer invests removed loss of load
- Generation capacity investments removed loss of load
- Storage investments helped with loss of load, but did not fully solve it
- All scenarios still have tiny amount of curtailments, but the values are very small and user should not be concerned about those

	A	B	C	D	E	F
1	Update sheets window	demoModel-1	demoModel-1	demoModel-1	demoModel-1	demoModel-1
2		Base	demo1_invest_transCap	demo1_invest_genCap	demo1_invest_storages	demo1_invest_all
20						
21	General results	elec	elec	elec	elec	elec
22	VRE share (% of annual demand)	8.554	8.554	13.49	8.554	13.74
23	Loss of load (% of annual demand)	2.368	0	0	1.474	0
24	-> ramp up constrained (% of annual demand)	0	0	0	0	0
25	Excess load (% of annual demand)	0	0	0	0	0
26	Insufficient reserves (% of reserve demand)	0	0	0	0	0
27	Insufficient inertia (% of inertia demand)					
28	Curtailment (% of VRE gen.)	-6.66E-06	-6.66E-06	-4.15E-06	-6.66E-06	-6.21E-06
29	-> ramp down constrained (% of VRE gen.)	0	3.07E-08	2.09E-08	0	2.51E-08
30	Peak load (MW)	2101.55	2101.55	2101.55	2101.55	2101.55
31	Peak net load (MW)	1946.3	1946.3	1934.72	1946.3	1933.66
32						
33	Flexibility issues	elec	elec	elec	elec	elec
34	Loss of load (max MW)	255.475	0	0	221.823	0
35	Excess load (max MW)	0	0	0	0	0
36	Reserve inadequacy (max MW)	0	0	0	0	0
37	Insufficient inertia (TWh/a)	0	0	0	0	0
38	Curtailment (max MW)	0.000137541	0.000137541	0.000618193	0.000137541	0.000787031
39	Curtailment (TWh/a)	-7.48E-08	-7.48E-08	-7.35E-08	-7.48E-08	-1.12E-07
40	Model leakage (TWh/a)	0	0	0	0	0
41	Capacity inadequacy (max MW)	0	0	0	0	0
42	Spill (TWh/a)	0	0	0	0	0

Comparing different investment options, 4/9

In results file

a) Open **summary_D** sheet

b) Check **costs** table

- Storage investment scenario has lower loss of load costs than base, but still significant
- Other scenarios have zero costs from loss of load
- All investment scenarios have lower total sum than base
- Which has the lowest total costs?

	A	B	C	D	E	F
1	Update sheets window	demoModel-1	demoModel-1	demoModel-1	demoModel-1	demoModel-1
2		Base	demo1_invest_transCap	demo1_invest_genCap	demo1_invest_storages	demo1_invest_all
56						
57	Costs	elec	elec	elec	elec	elec
58	Cost operations (M CUR)	609.876	574.333	487.883	617.898	473.78
59	Cost investments (M CUR)	0	4.86935	68.3158	1.10063	47.0795
60	Fixed annual costs (M CUR)	101.251	101.251	126.477	103.606	112.337
61	Cost loss of load (M CUR)	3110.96	0	0	1937.44	0
62	Cost excess load (M CUR)	0	0	0	0	0
63	Cost curtailment (M CUR)	-1.50E-06	-1.50E-06	-1.47E-06	-1.50E-06	-2.24E-06
64	Cost of insufficient reserves (M CUR)	0	0	0	0	0
65	Cost of insufficient inertia (M CUR)	0	0	0	0	0
66	Cost of insufficient capacity (M CUR)	0	0	0	0	0

Comparing different investment options, 5/9

In results file

- a) Open **summary_D** sheet
 - b) Check capacity investments from **unit type capacity (MW)** table
 - c) Check transmission investments from **transfer Capacity (MW)** table
- Investments are highlighted at figures on the right
 - First three scenarios invest into only one of the technology baskets (transmissions, capacity, storages) as defined
 - The fourth one was able to invest to technologies from each basket and decided to do that
 - Combination solution did not invest to additional coal or oil capacity, but chose additional gas, biomass, VRE, storages, and transmission

	A	B	C	D	E	F
1	Update sheets window	demoModel-1	demoModel-1	demoModel-1	demoModel-1	demoModel-1
2		Base	demo1_invest_transCap	demo1_invest_genCap	demo1_invest_storages	demo1_invest_all
78						
79	Unit type	Capacity (MW)	Capacity (MW)	Capacity (MW)	Capacity (MW)	Capacity (MW)
80	ST_coal	1000	1000	1200	1000	1000
81	Engine_gas	300	300	353.884	300	400
82	CC_oil	620	620	732.193	620	620
83	ST_bio	45	45	105	45	105
84	Hydro_RES	150	150	150	150	150
85	Hydro_ROR	120	120	120	120	120
86	wind	150.02	150.02	300.02	150.02	300.02
87	PV	60	60	260	60	260
88	battery	0.04	0.04	0.04	117.8	4.315

	A	B	C	D	E	F
1	Update sheets window	demoModel-1	demoModel-1	demoModel-1	demoModel-1	demoModel-1
2		Base	demo1_invest_transCap	demo1_invest_genCap	demo1_invest_storages	demo1_invest_all
110						
111	Transfer	Capacity (MW)	Capacity (MW)	Capacity (MW)	Capacity (MW)	Capacity (MW)
112	nodeA - nodeB	150	439.925	150	150	474.512
113	nodeB - nodeA	150	439.925	150	150	474.512
114	nodeB - nodeC	100	405.766	100	100	455.325
115	nodeC - nodeB	100	405.766	100	100	455.325

In results file

a) Open `genUnitGroup_elec_plot` sheet

- Check how the model dispatched the units
- Figures on the right show high demand week (4th week) in base run and `invest_all` run
- You can change the week from a scroll bar at the top
- Notice that demand peak is after the sunset, but PV is still profitable investment because it allows lower oil consumption
- With PV, the model runs oil capacity to provide the peak load when needed
- On the right, low and high demand weeks from `invest_all` scenario

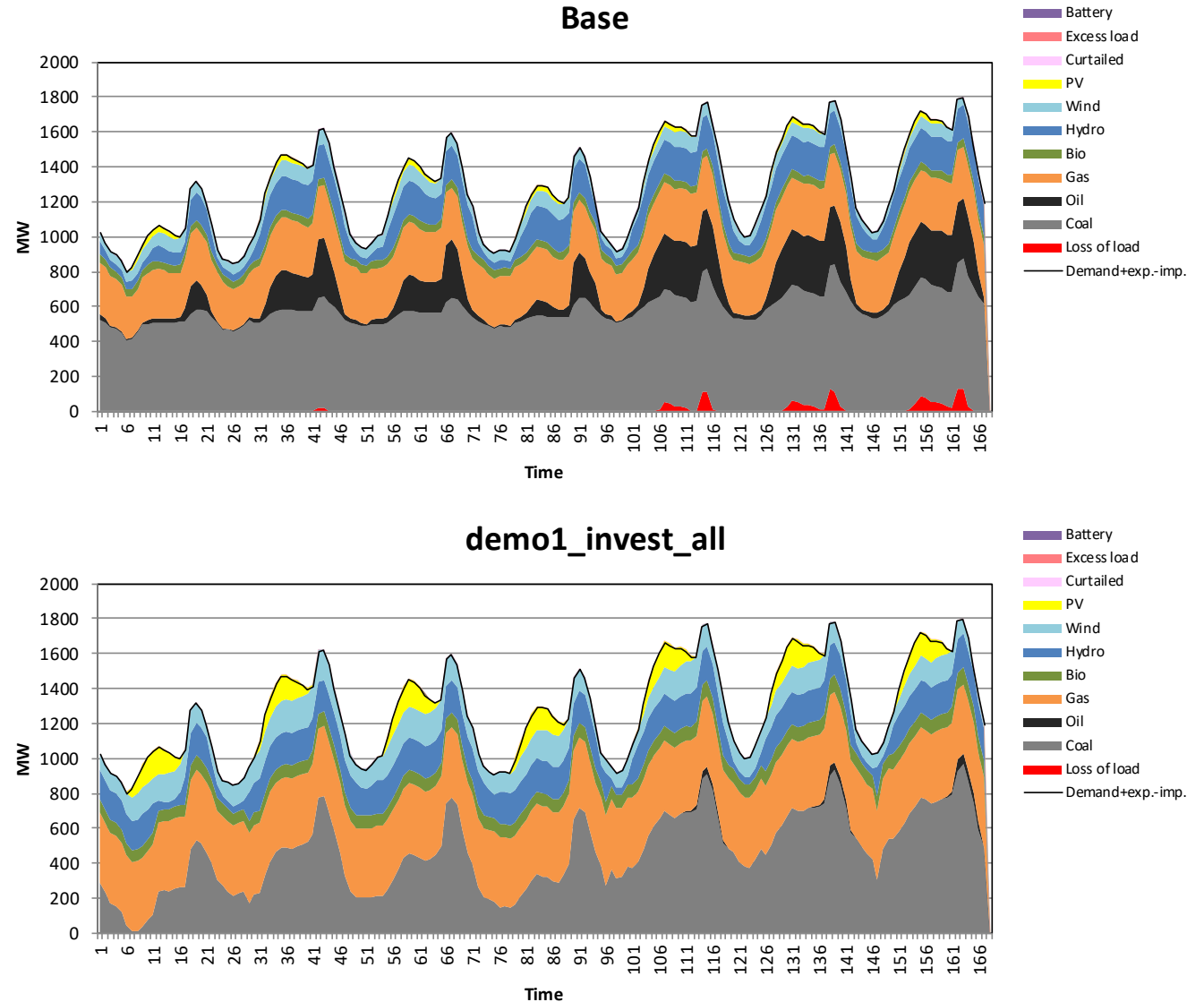

Comparing different investment options, 7/9

In results file

a) Open `units_invest_plot` sheet

- First figure shows invested capacities per node
- First figure on the second row shows the same figures for storage capacity

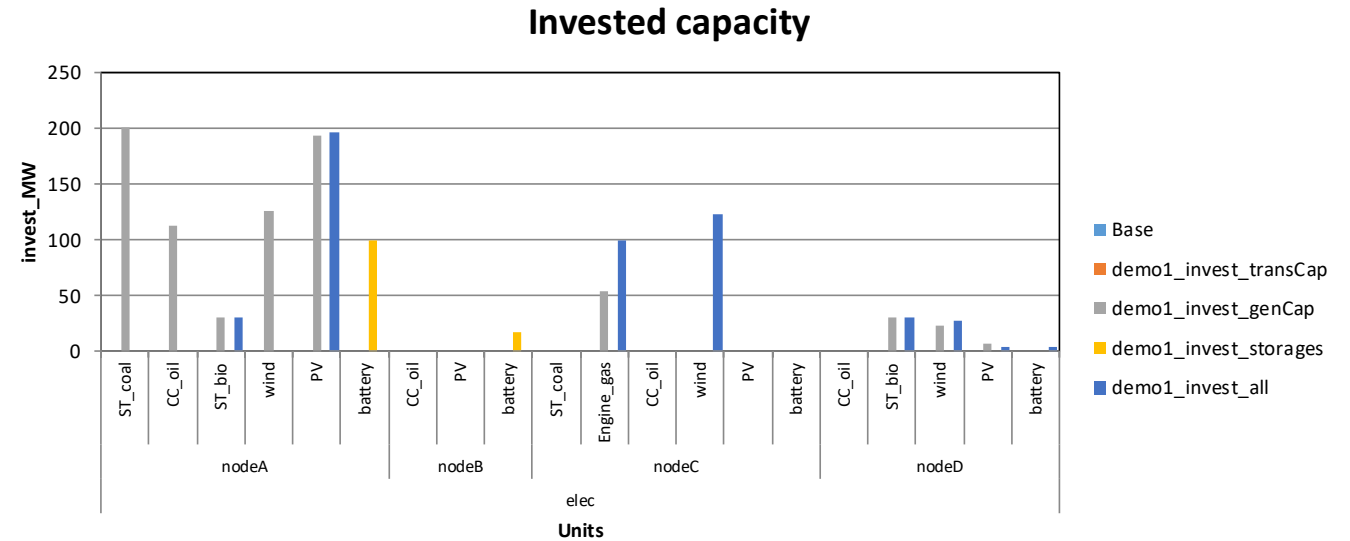

b) Open `transfers_invest_plot` sheet

- Figures show invested transfer capacity and shadow value of additional investments

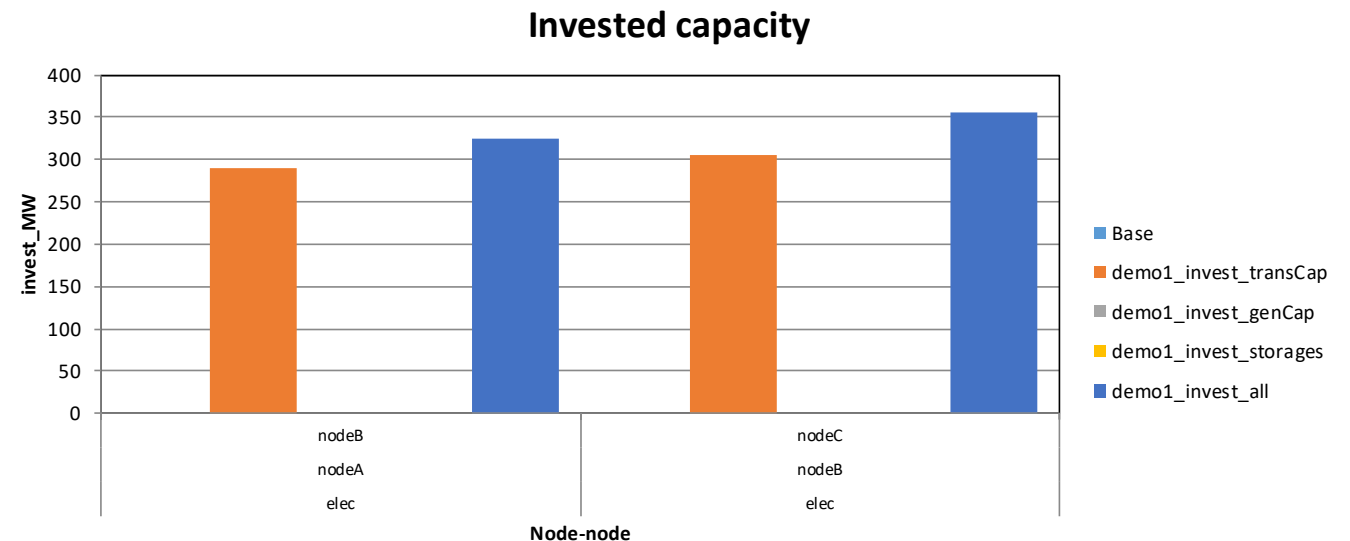

Comparing different investment options, 8/9

In results file

a) Open `units_invest_plot` sheet

- Shadow value is a model parameter that tells if additional investment on that technology would reduce total costs or not
- If some technology has positive shadow value, investment would increase the overall costs (*i.e.*, not profitable)
- If some technology has negative shadow value, additional investments would decrease the total costs, but some constraint did not allow additional investments
- In demo model 1, the maximum allowed investments were predefined and storage scenario would have been cheaper if model could have invested to larger storages.

Shadow value for additional capacity

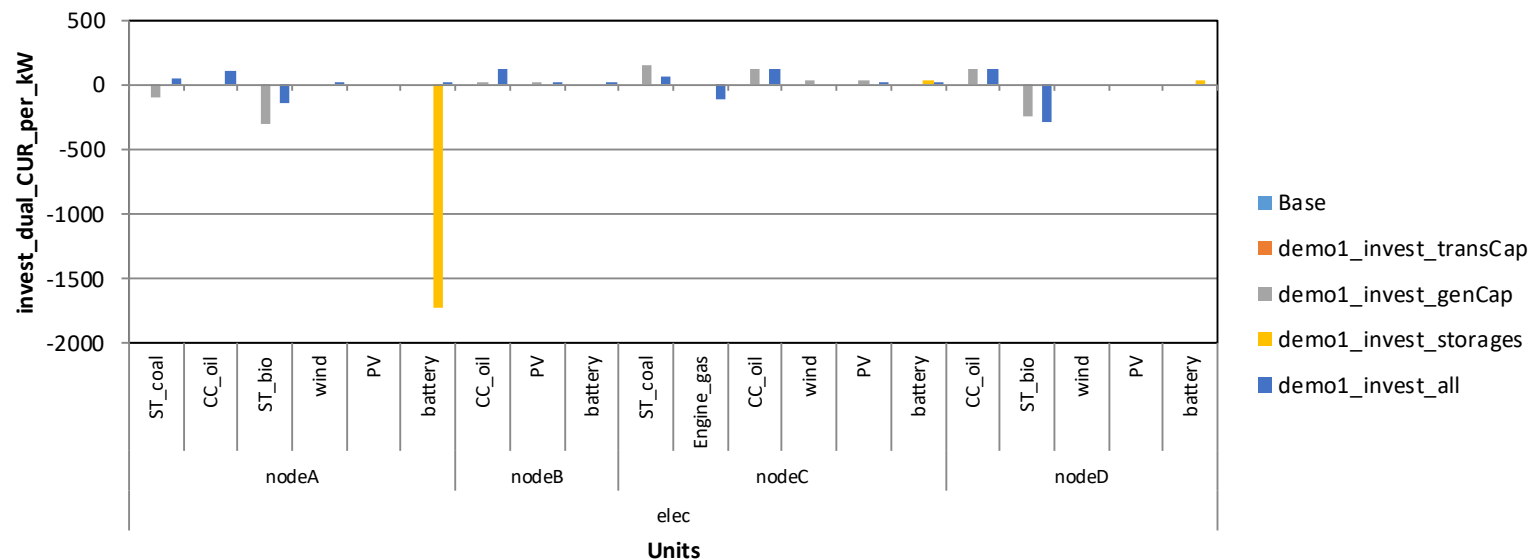

Comparing different investment options, 9/9

In results file

a) Open `costs_plot` sheet

- FlexTool calculates a large range of different costs and shows detailed results
- On right is a breakdown of fuel costs and (annualised) investment costs
- Results file shows also many other categories

Fuel costs

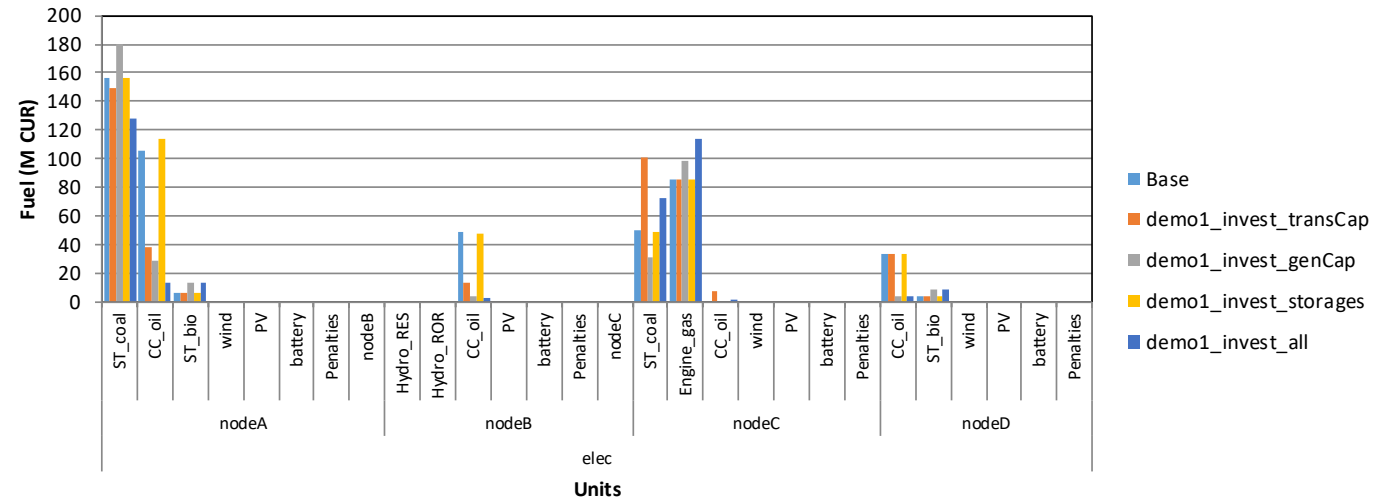

Investment costs

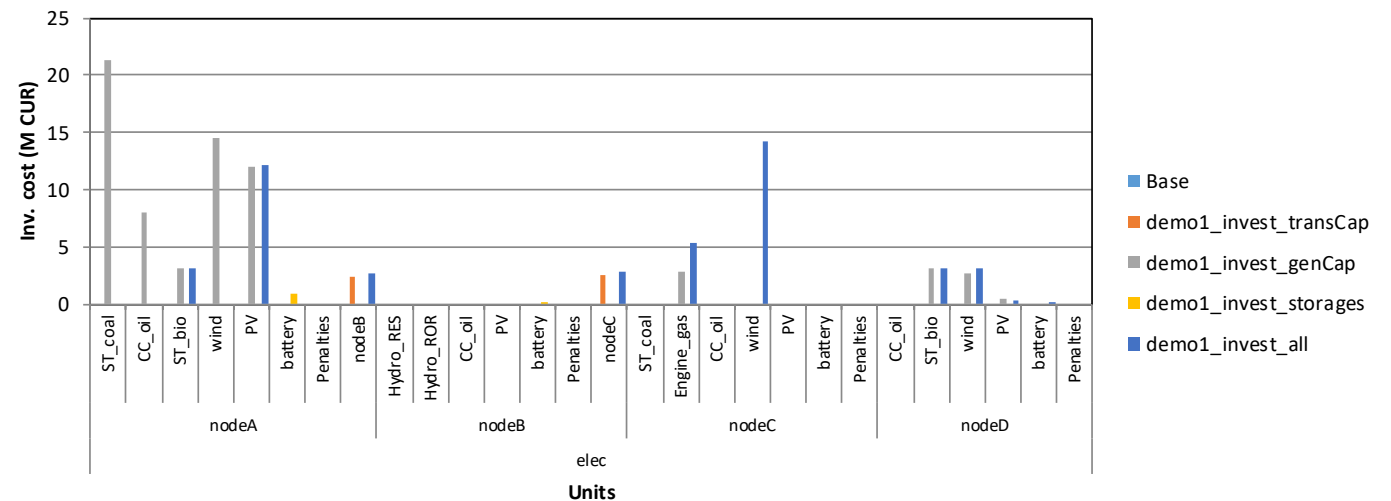



Assessing flexibility enablers, 1/4

1. Interconnection capacity (to other countries)

- With demoModel, we do not know the capacity, but annual imported energy is less than 3% of annual demand
- See input data file (demoModel-1.xlsm) sheet **gridNode**
- Flagged low, but more data needed in real case studies

2. Generator ramping capabilities

- No ramping issues identified
- Flagged high here, but in a real case study, do a full year run and consult the system operator. There might be something you did not capture with the existing model
- See slide comments for discussion on possible ramping constraint issues and modelling approaches.

Flexibility enablers in the demo model 1

Flexibility enablers	High	Medium	Low
1. Interconnection capacity vs. average demand			●
2. Generator ramping capabilities	●		
3. Matching of demand with VRE generation			
4. Hydro inflow stability			
5. Strength of internal grid			
6. Storage vs. annual demand			
7. Geographical dispersion of VRE generation and demand			
8. Minimum demand vs. VRE capacity			

3. Matching demand with VRE

- Peak demand after sunset, see dispatch figures
- Annual time series of wind and solar does not have large seasonal variability (input data file, sheet [ts_cf](#))

4. Hydro inflow stability

- Run of river hydro (Hydro_ROR) production has large variance between seasons (input data file, sheet [ts_inflow](#))
- Reservoir hydro inflow more stable between the seasons
- No data about different years

Both flagged medium here, but in real case study, more data needed. Could be also low.

Flexibility enablers in the demo model 1

Flexibility enablers	High	Medium	Low
1. Interconnection capacity vs. average demand			●
2. Generator ramping capabilities	●		
3. Matching of demand with VRE generation		●	
4. Hydro inflow stability		●	
5. Strength of internal grid			
6. Storage vs. annual demand			
7. Geographical dispersion of VRE generation and demand			
8. Minimum demand vs. VRE capacity			

5. Strength of internal grid

- NodeA has loss of load and nodeC has excess capacity. Transmission lines do not have enough capacity.
- The current situation is that nodeA-nodeB is 150 MW, and nodeB-nodeC is 100MW
- After investments, model increases the capacity of both up to the level of 410-480 MW
- Flagged low

6. Storage vs. annual demand

- Check storage capacity from input data **units** sheet
- Check annual demand from input data **gridNode** sheet
- Calculate the storage / total annual demand (~1%)
- The storage is 1000h FLH for that reservoir hydro unit, but small compared to annual demand
- Flagged low

Flexibility enablers in the demo model 1

Flexibility enablers	High	Medium	Low
1. Interconnection capacity vs. average demand			●
2. Generator ramping capabilities	●		
3. Matching of demand with VRE generation		●	
4. Hydro inflow stability		●	
5. Strength of internal grid			●
6. Storage vs. annual demand			●
7. Geographical dispersion of VRE generation and demand			
8. Minimum demand vs. VRE capacity			

7. Geographic dispersion of VRE generation and demand

- Check node level demand from input data **gridNode** sheet
- Check nodal level VRE generation from results file **units_elec** sheet, base run
 - NodeA – 53% of demand, 2% of VRE generation
 - NodeB – 17% of demand, 60% of VRE generation
 - NodeC – 27% of demand, 37% of VRE generation
 - NodeD – 3% of demand, 1% of VRE generation
- Flagged low, but could be medium because of possible investments

8. Minimum demand vs. VRE capacity

- Check minimum net load (demand + exp – imp – VRE) from results file from **genUnit_elec** sheet (730 MW, no issues)
- In invest_all scenario, the minimum net load is 675 MW, no issues there either

Flexibility enablers in the demo model 1

Flexibility enablers	High	Medium	Low
1. Interconnection capacity vs. average demand			●
2. Generator ramping capabilities	●		
3. Matching of demand with VRE generation		●	
4. Hydro inflow stability		●	
5. Strength of internal grid			●
6. Storage vs. annual demand			●
7. Geographical dispersion of VRE generation and demand			●
8. Minimum demand vs. VRE capacity	●		

Selecting the modelled days for demoModel 1

- Selected representative time series were based on
 - Net load (min and max)
 - Inflow (min and max)
- Open file [input/demoModel-1-select-weeks.xlsx](#)**
 - The file is very slow to use,
 - Closing additional excel files speeds up things a bit
- Selecting 4 weeks for dispatch and 4 days for invest
 - 1 week/day with max net load
 - 1 week/day with min net load
 - 1 week/day with max inflow
 - 1 week/day with min inflow
- Quality check by comparing the duration curves of the full year to selected time series (figures at right)
 - 4 days is too small sample, but we will still use it to get faster model run times

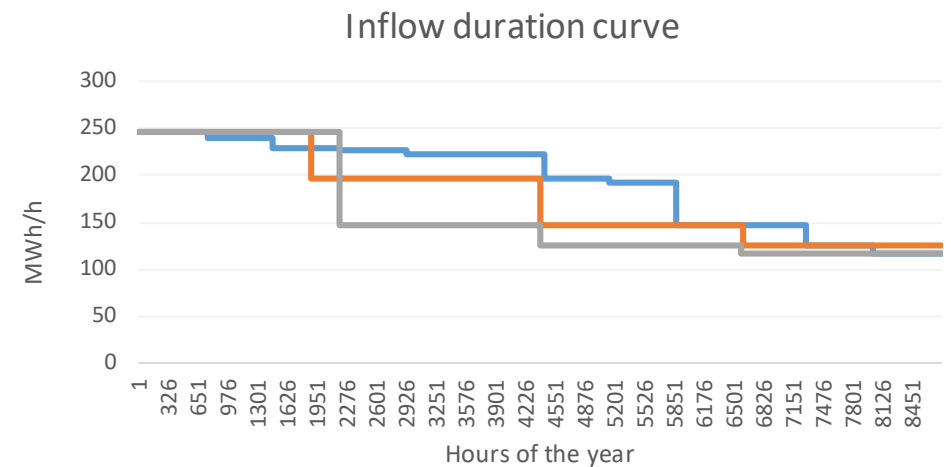
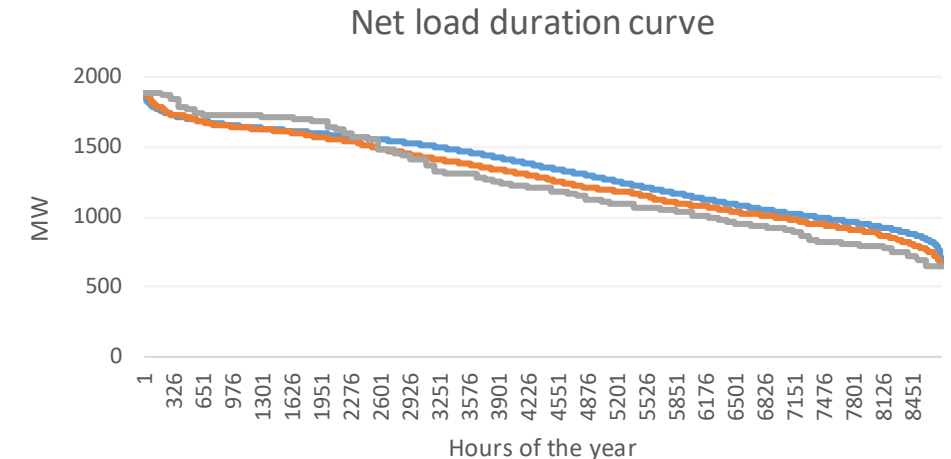



Running flexibility assessments with demo models – Demo model 2

Open

- [inputData\demoModel-2-2017.xlsm](#)
- [inputData\demoModel-2-2030.xlsm](#)
- This demo model demonstrates a case study of assessing current situation (2017) and capacity expansion plan (2030)
- It has two files, one for each year. See differences in units sheet
- New investments for 2030 are natural gas plant to nodeC, wind power to nodeA and small shares of PV to all nodes

Mainland nodeGroup

- Shared synchronous area (max 80% non synchronous), shared reserves (6% of hourly demand)
- Additional node-level constraints: part of reserves in each node (3% of hourly demand), max 90% non-synchronous in each node

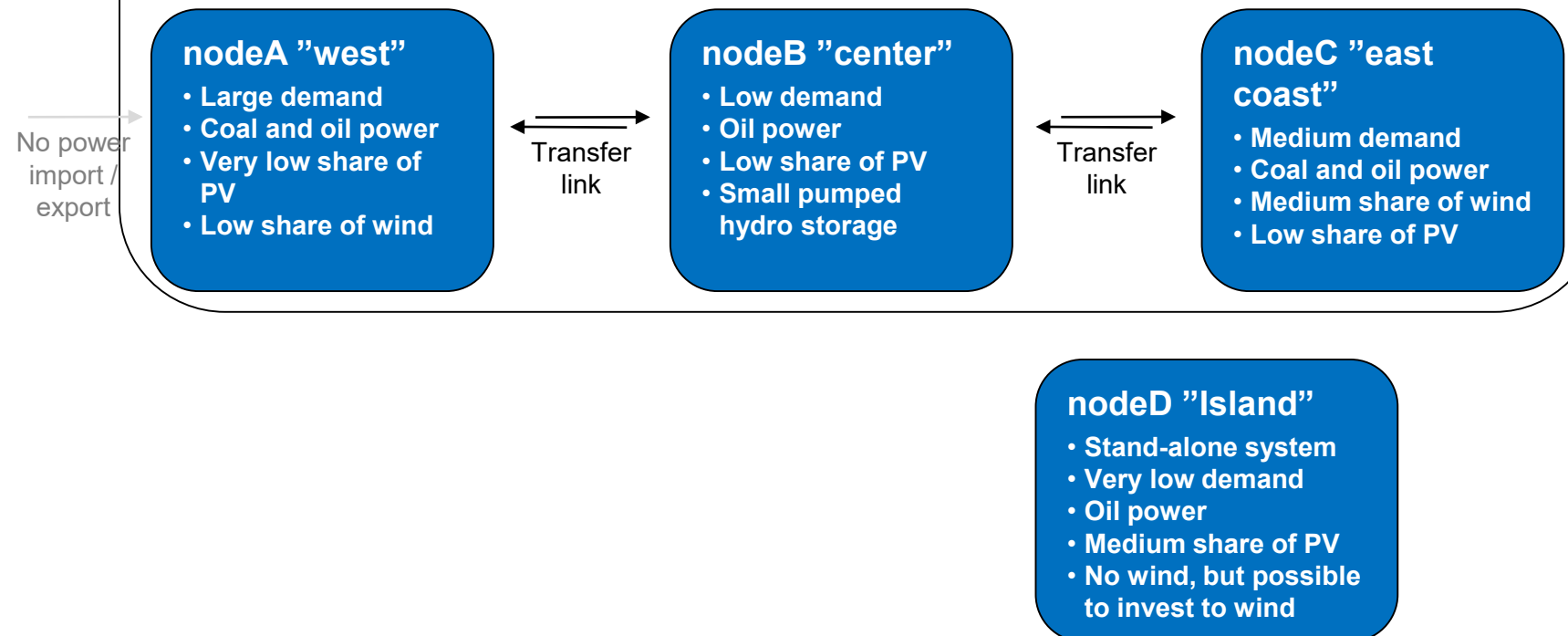

Selecting modelled days

- Selecting **representative time series** based on
 - Net load (min and max)
 - Net load nodeD (max)
 - Criteria needs to be considered for each case study and country separately
- **Ramp rate constraints turned on** in input data
 - Open master sheet in input data file.
 - FlexTool models ramp rates only if use_ramps = 1.

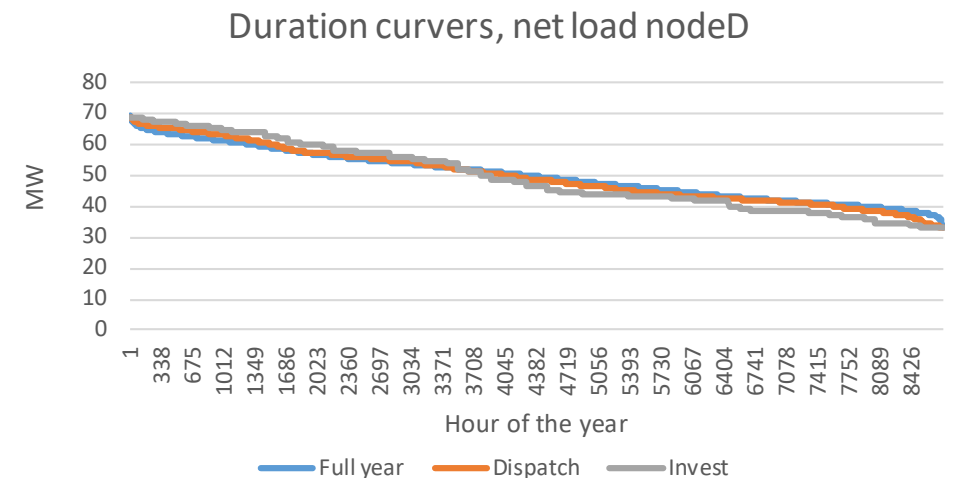
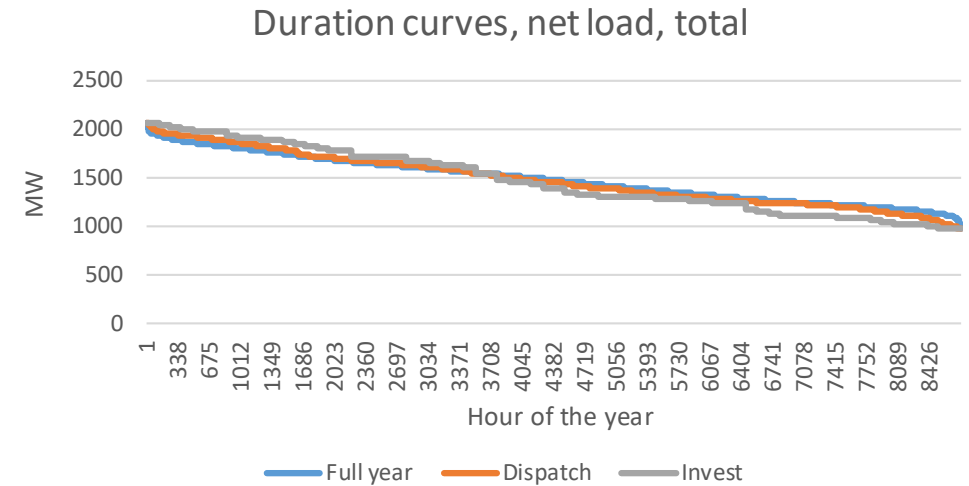

Quick check of flexibility issues

- Run base run of demo model 2 (choose both 2017 and 2030).
 - See instructions from day 1 presentation if needed
 - Check **General results, Flexibility issues, and costs** from **Summary_D**
- No flexibility issues found
- Only tiny amount of curtailments

	A	B	C
1	Update sheets window	demoModel-2-2017	demoModel-2-2030
2		Base	Base
13			
14	General results	elec	elec
15	VRE share (% of annual demand)	4.981	8.988
16	Loss of load (% of demand)	0	0
17	-> ramp up constrained (% of demand)	0	0
18	Insufficient reserves (% of reserve demand)	0	0
19	Curtailment (% of VRE gen.)	0	0.007814
20	-> ramp down constrained (% of VRE gen.)	0	0
21	Peak load (MW)	2071.46	2071.46
22	Peak net load (MW)	2047.44	2027.24
23			
24	Flexibility issues	elec	elec
25	Loss of load (max MW)	0	0
26	Reserve inadequacy (max MW)	0	0
27	Insufficient inertia (TWh/a)	0	0
28	Curtailment (max MW)	0	1.65328
29	Curtailment (TWh/a)	0	9.23E-05
30	Model leakage (TWh/a)	0	0
31	Capacity inadequacy (max MW)	0	0
32	Spill (TWh/a)	0	0

	A	B	C
1	Update sheets window	demoModel-2-2017	demoModel-2-2030
2		Base	Base
45			
46	Costs	elec	elec
47	Cost operations (M CUR)	1259.05	984.279
48	Cost investments (M CUR)	0	0
49	Fixed annual costs (M CUR)	113.7	128.5
50	Cost loss of load (M CUR)	0	0
51	Cost curtailment (M CUR)	0	0.00184587
52	Cost of insufficient reserves (M CUR)	0	0
53	Cost of insufficient inertia (M CUR)	0	0
54	Cost of insufficient capacity (M CUR)	0	0

Digging deeper into flexibility, 1/3

- **Identify the source of curtailments** Check node results (node_plot)
 - Curtailments in nodeD
- Check **rampRoom_1h_elec_nodeX_plot** sheet to study ramping capabilities of different nodes
 - All nodes have enough ramping capability
 - NodeB at 2030 has limited downward ramping capability within the node, but vary good ramping capabilities when adding transfer connections

VRE curtailment

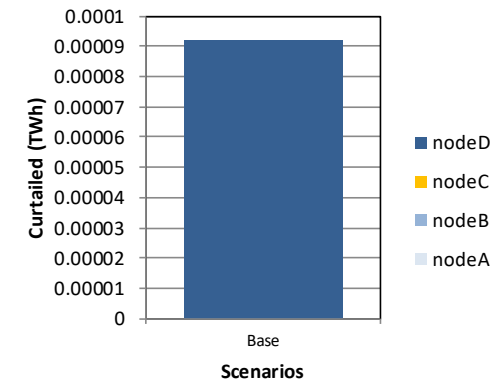

Base

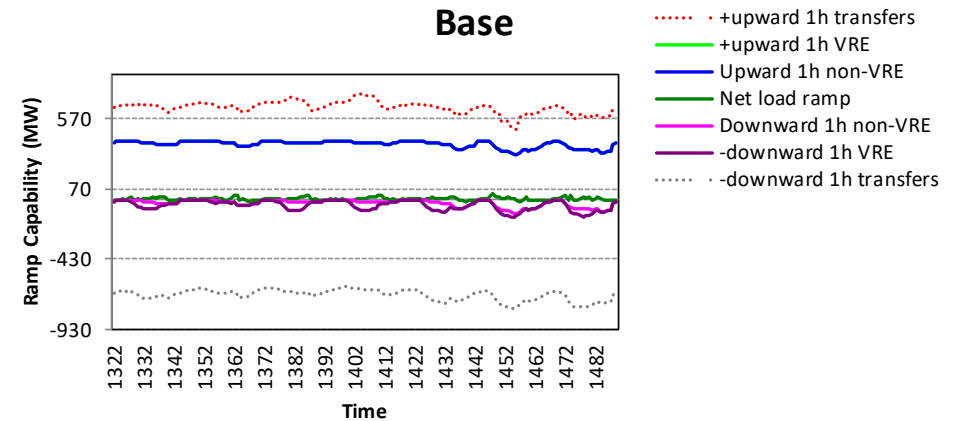

Open dispatch figures from sheet `genUnitGroup_elec_plot`

- The first week has the lowest demand, third week has the highest net load
- Use scroll bar to change the week. If it does not work, check that formula calculation is automatic
- Minimum loads of coal and gas units seem to be ok in the 2030 run
- If there are many small oil units, they should be ok too

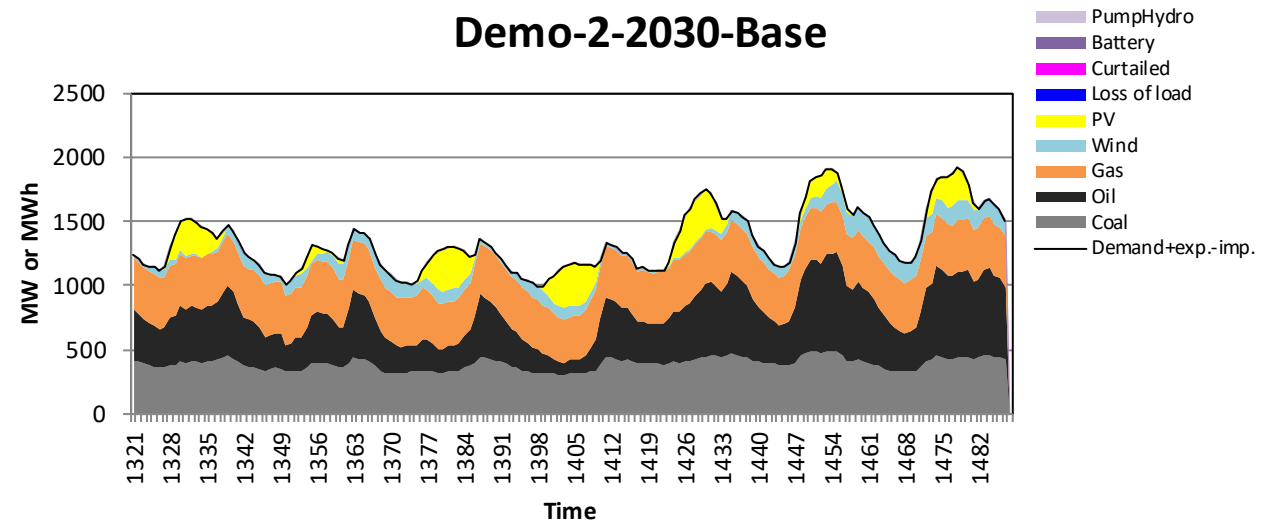
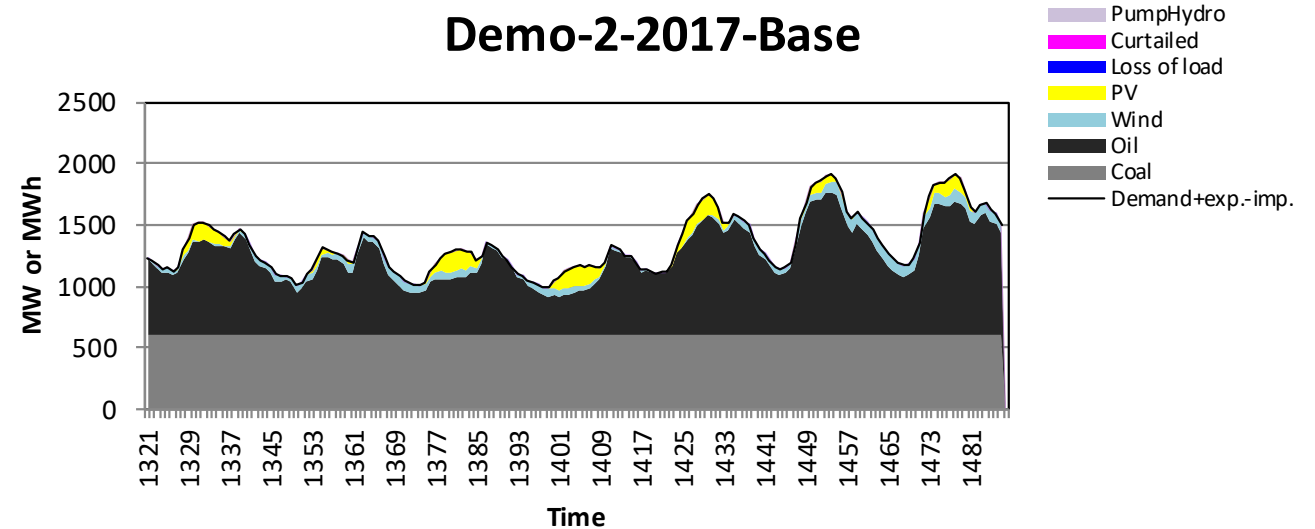



Digging deeper into flexibility, 3/3

Why does nodeD have curtailments?

- See 'genUnit_elec' sheet
- Find during which hours 'nodeD' has curtailments (1403-1406)
- The reason is that during these hours, local non-synchronous share grows to 80% and the VRE generation is curtailed
- The maximum non-synchronous share is defined in the input data ('gridNode' sheet and 'nodeGroups' sheet)



Predefined investment runs

- Predefined investment runs allow users to easily try alternative investment plans
- Select following scenarios in flexTool.xlsxm and run them with Base scenario
 - Storages scenario adds 5 MW battery storages to nodeD (island node with minor curtailments)
 - PV scenario forces FlexTool to invest to additional 100 MW of PV in nodeA, 50 MW of PV in nodeB, and 100 MW of PV in nodeC
 - See flexTool.xlsxm sensitivity definition sheet how these two scenarios are defined

Active input files:	Inactive input files:	Active scenarios:	Inactive scenarios:
	<> template.xlsxm	Base	<>
	<>		<> Invest
	<> demoModel-1.xlsxm		<> demo1_inv
	<>		<> demo1_inv
	<> demoModel-2-2017.xlsxm		<> demo1_inv
demoModel-2-2030.xlsxm	<>		<> demo1_inv
	<>		<>
	<> template-EVs.xlsxm	demo2_storages	<>
	<> template-Storages.xlsxm	demo2_PV	<>
	<>		<>
	<>		<>



Quick check of results

- Open '**summary_D**' sheet from results file
- Check **General results, Flexibility issues, and costs**
 - Did storage capacity help with the curtailments in 'nodeD'?
 - Which scenarios had the lowest costs?
 - How much curtailments increased when the PV capacity increased from 300 MW to 550 MW?
 - Answers in slide comments



Free investment run

Select and run base and invest scenarios

- DemoModel-2-2030 is allowed to invest to transmission capacity, storages, and any kind of capacity (excluding reservoir hydro)
- The prices are estimated 2030 prices which means lower wind, PV, and battery prices than currently
- This kind of checks are useful when
 - Wanting to check how model solves some flexibility issue
 - Discussing about the long term planning

Active input files:	Inactive input files:	Active scenarios:	Ina
	<-> template.xlsxm	Base	<->
	<->	Invest	<->
	<-> demoModel-1.xlsxm		<->
	<->		<-> der
	<-> demoModel-2-2017.xlsxm		<-> der
demoModel-2-2030.xlsxm	<->		<-> der
	<->		<-> der
	<-> template-EVs.xlsxm		<->

Checking results of free investment run, 1/7

- Check **unit_type**, **capacity (MW)** and **Transfer, capacity (MW)** from **Summary_D** for capacity comparison between base and invest
- Check **units_invest_plot** to see the specific nodes where units are invested
 - Wind power in all allowed nodes
 - Pumped hydro storage in nodeB
 - Additional PV to nodeA

	A	B	C
1	Update sheets	demoModel-2-2030	demoModel-2-2030
2		Base	Invest
65			
66	Unit type	Capacity (MW)	Capacity (MW)
67	ST_coal	600	600
68	gas_CC	300	300
69	gas_CT	100	300
70	CC_oil	1580	1580
71	wind	250	1319.89
72	PV	300	591.362
73	battery	5	5
74	pumpHydro	10	87.992

	A	B	C
1	Update sheets	demoModel-2-2030	demoModel-2-2030
2		Base	Invest
75			
96	Transfer	Capacity (MW)	Capacity (MW)
97	nodeA - nodeB	250	398.49
98	nodeB - nodeA	250	398.49
99	nodeB - nodeC	200	616.891
100	nodeC - nodeB	200	616.891

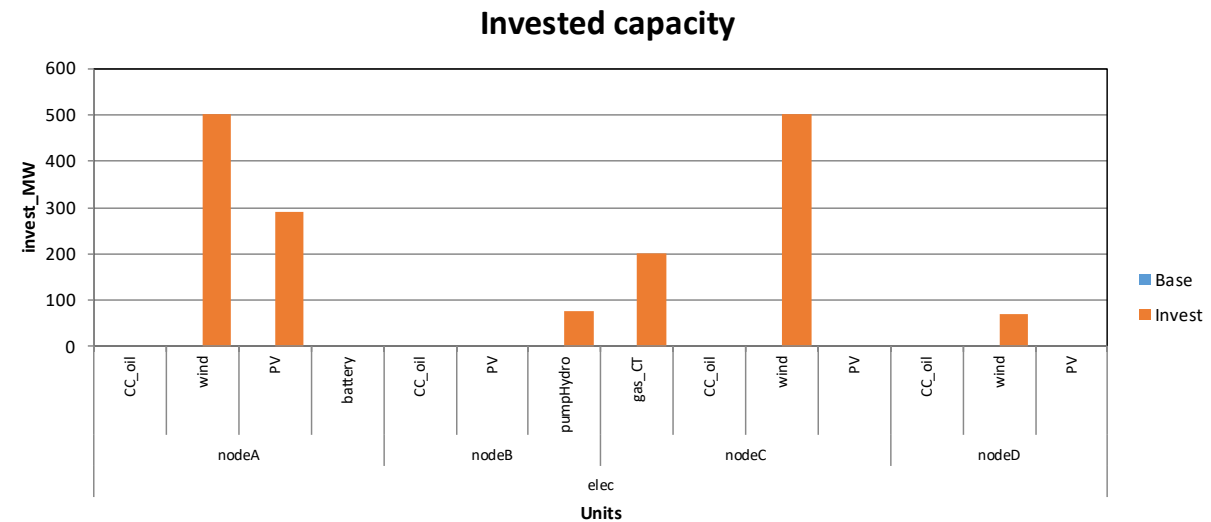

Checking results of free investment run, 2/7

- genUnitGroup_elec_plot shows dispatch figures for high demand week (3rd) and low demand week (1st)

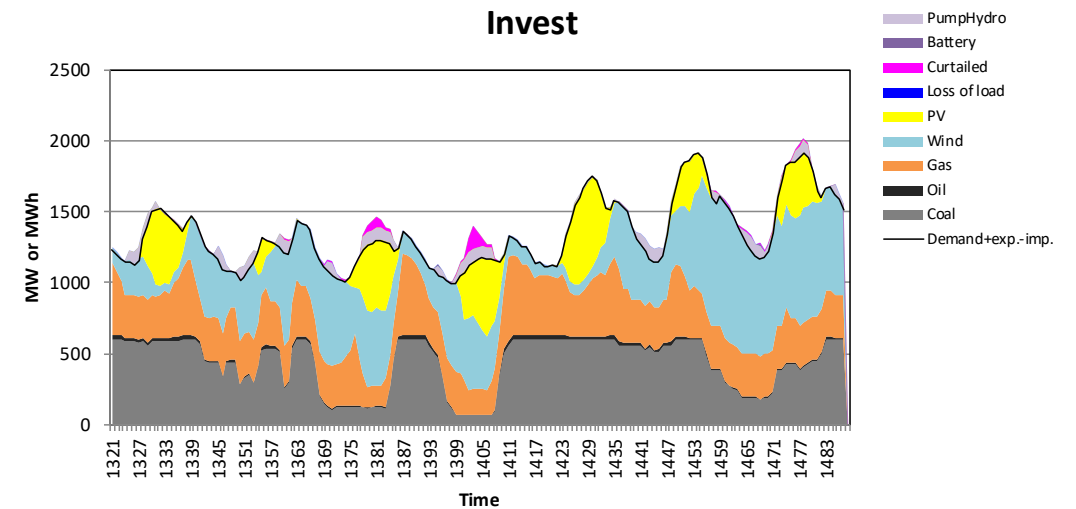
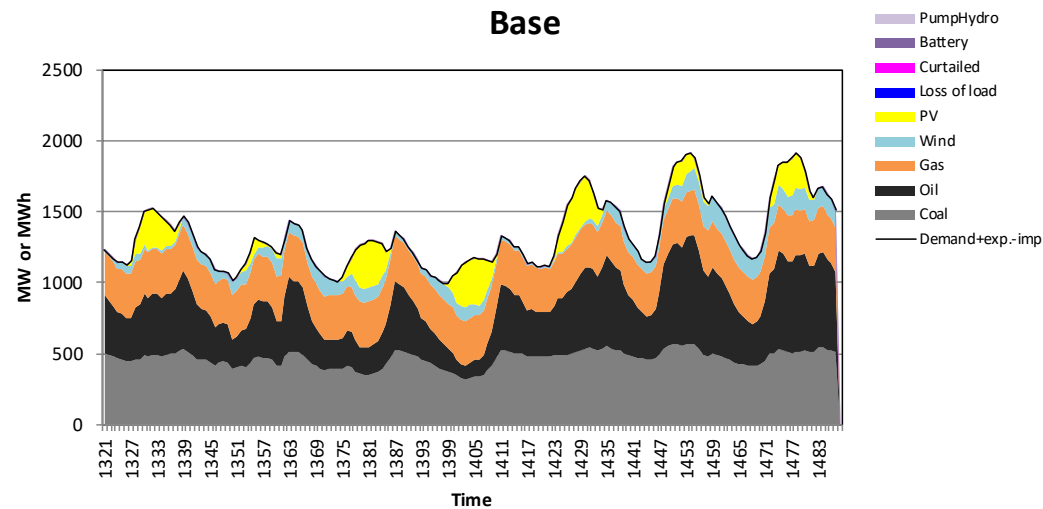
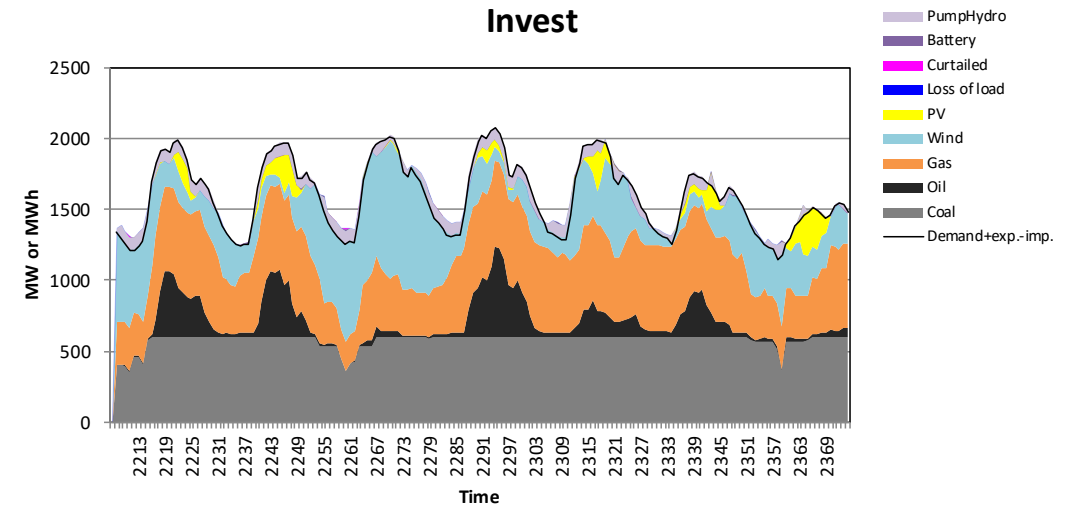
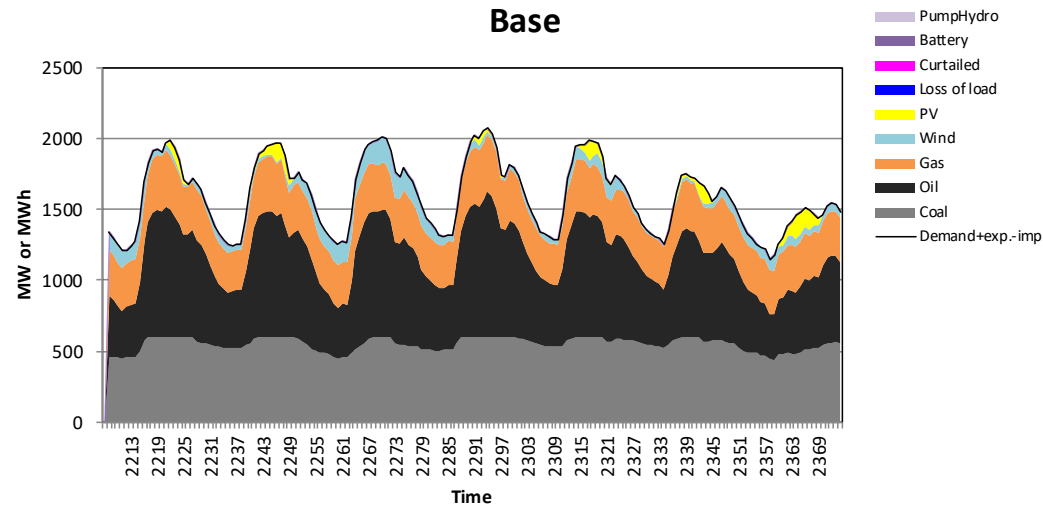

Checking results of free investment run, 3/7

- Check **summary_D** for flexibility issues in general and **node_plot** for graphical version
 - Investment scenario has higher VRE share (9 % -> 34 %)
 - This leads to some additional curtailments, but considerably lower total costs
- Investment scenario can have higher curtailments than base scenario, because savings in fuel costs are larger than (annualised) investment costs + curtailment penalties

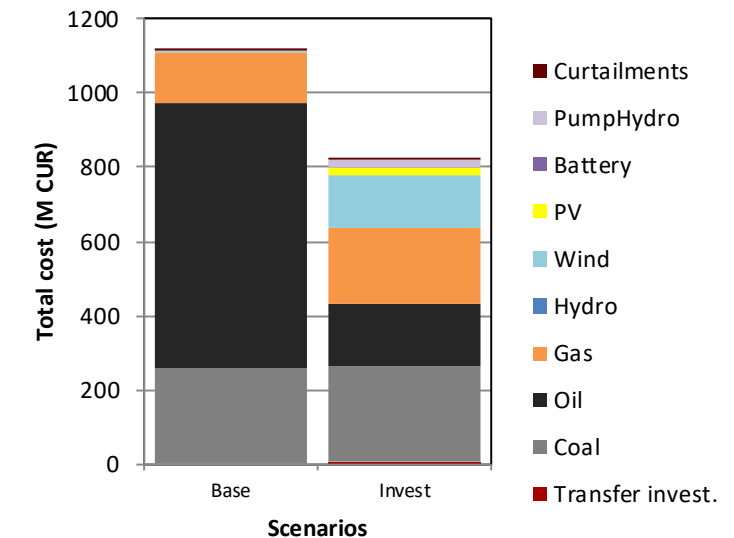
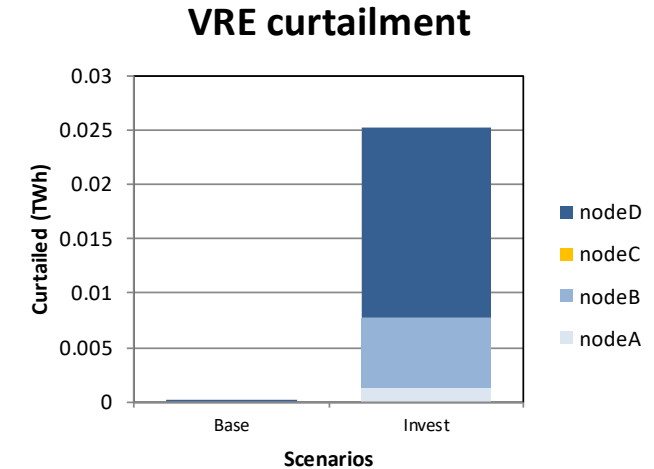

Checking results of free investment run, 4/7

- Check **units_invest_plot** to see the specific nodes where units are invested
 - Investment shadow value tells how additional investments to each capacity type would affect the costs
 - Gas and wind have negative shadow values, which means that additional investments to these technologies would lower the total costs
 - Their investments are limited by investment constraints in the input data

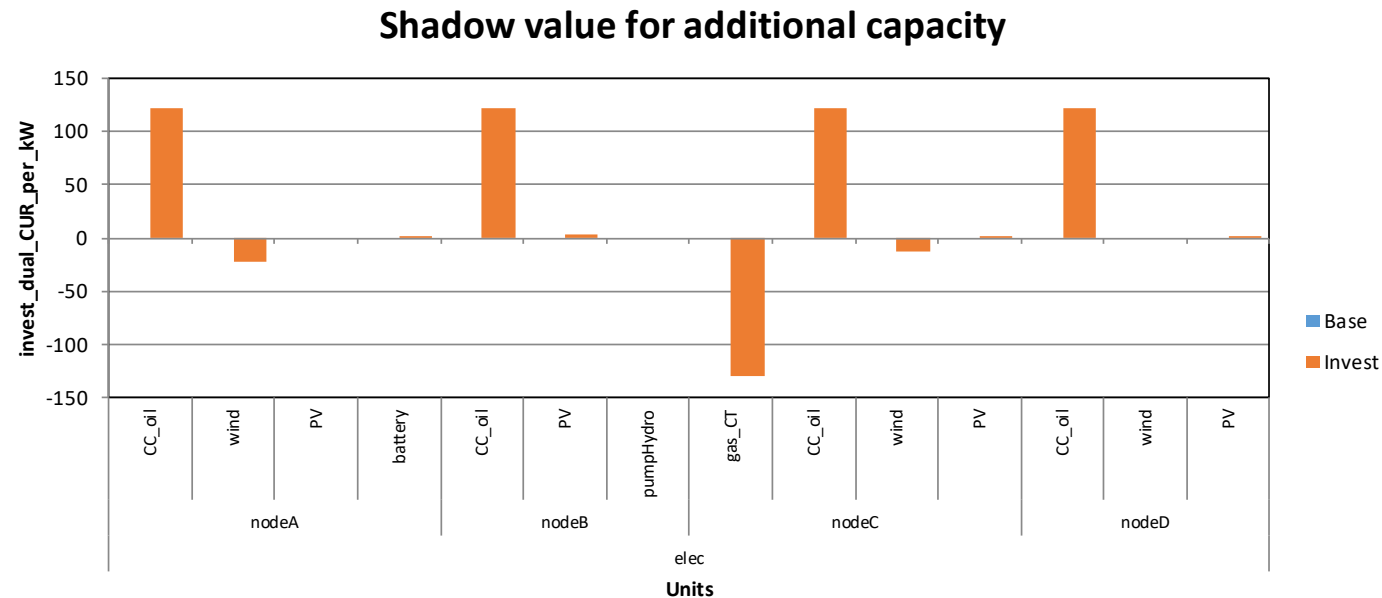



Removing max_investment limits to wind and gas

Select and run following 3 scenarios

- WindGas scenario removes max_investment limits to wind power and gas turbines

Active input files:	Inactive input files:	Active scenarios:	Inactive scenarios:
	<> template.xlsxm	Base	<>
	<>	Invest	<>
	<> demoModel-1.xlsxm		<>
	<>		<> demo1_invest_transCap
	<> demoModel-2-2017.xlsxm		<> demo1_invest_genCap
demoModel-2-2030.xlsxm	<>		<> demo1_invest_storages
	<>		<> demo1_invest_all
	<> template-EVs.xlsxm		<>
	<> template-Storages.xlsxm		<> demo2_storages
	<>		<> demo2_PV
	<>	demo2_windGas	<>

Checking results of free investment run, 5/7

- Check **unit_type**, **capacity (MW)** and **Transfer, capacity (MW)** from **Summary_D** to compare invest capacity in scenarios
- Check **units_invest_plot** to see the specific nodes where units are invested
 - Total amount of natural gas increased
 - Slightly more wind, but it was built mostly to nodeA instead of nodeA + nodeD
 - Slightly lower amount of solar PV due to increased amount of wind
 - Battery storages replaced pumped hydro storages
 - All shadow prices positive (investments not limited by user anymore)

	A	B	C	D
1	Update sheets	demoModel-2-2	demoModel-2-2	demoModel-2-20
2		Base	Invest	demo2_windGas
65				
66	Unit type	Capacity (MW)	Capacity (MW)	Capacity (MW)
67	ST_coal	600	600	600
68	gas_CC	300	300	300
69	gas_CT	100	300	654.002
70	CC_oil	1580	1580	1580
71	wind	250	1319.89	1375.85
72	PV	300	591.362	400.621
73	battery	5	5	39.049
74	pumpHydro	10	87.992	10

	A	B	C	D
1	Update sheets	demoModel-2-2	demoModel-2-2	demoModel-2-203
2		Base	Invest	demo2_windGas
35				
36	Transfer	Capacity (MW)	Capacity (MW)	Capacity (MW)
37	nodeA - nodeB	250	398.49	525.245
38	nodeB - nodeA	250	398.49	525.245
39	nodeB - nodeC	200	616.891	802.939
40	nodeC - nodeB	200	616.891	802.939

Invested capacity

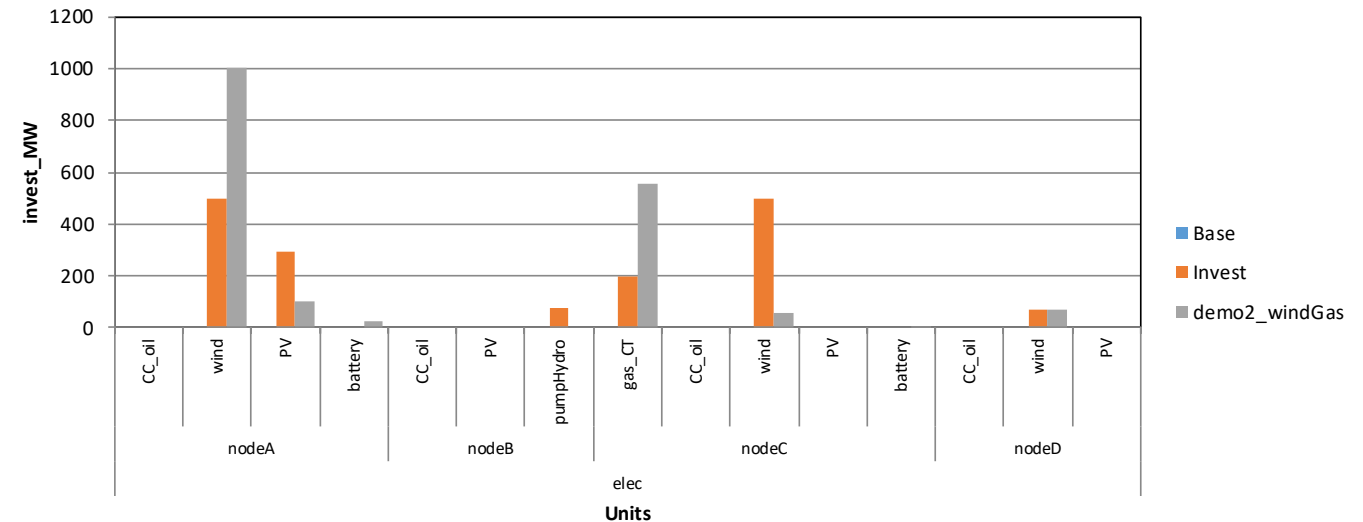

Checking results of free investment run, 6/7

- genUnitGroup_elec_plot shows dispatch figures for high demand week (3rd) and low demand week (1st)

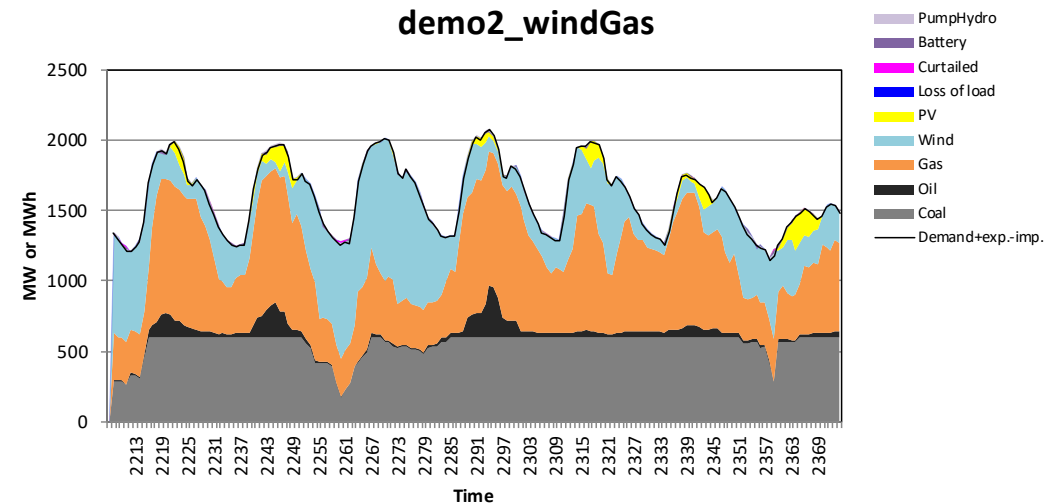
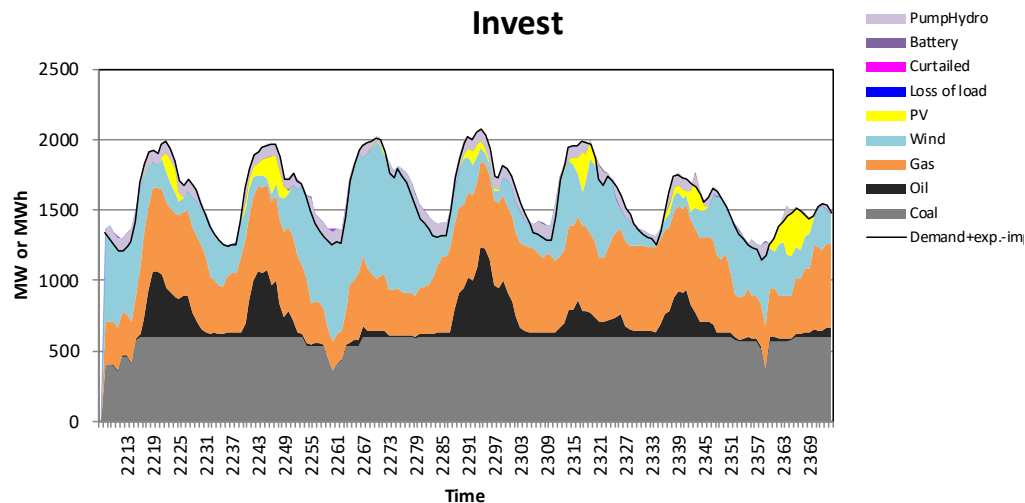
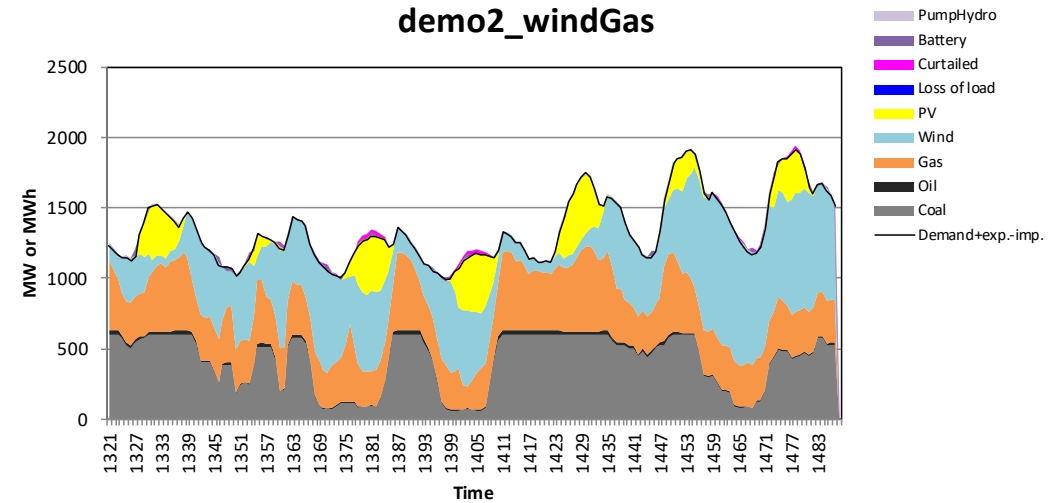
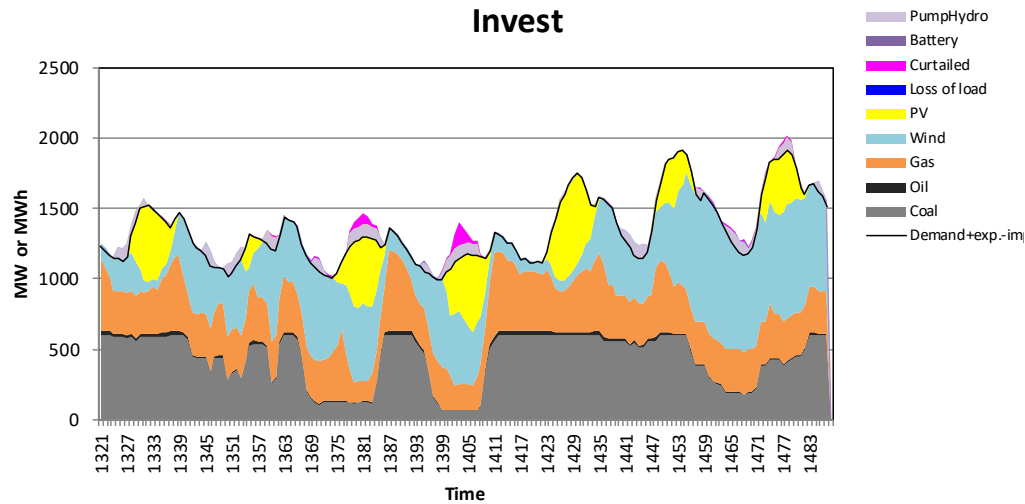

The conclusion seems to be that

- Higher VRE share is cost-effective, allowing the power system to be flexible to operate with higher VRE
- If possible, it would be better to position VRE capacity near the demand (nodeA in this example)
- However, this was an example, additional modeling is needed to assess large VRE shares.
- Additional natural gas capacity would also decrease the total costs by replacing oil power
- In this topic, additional modelling needed about
 - the acceptable minimum loads and annual running hours of the thermal capacity
 - Possible required additional investments to natural gas grid (locations, if operating at full capacity or not, etc)

- **VTT Technical Research Centre of Finland**
 - Juha Kiviluoma – Main developer of the tool
 - Tomi Lindroos – Tool testing and analysis of case studies
 - Simo Rissanen – Tool code developer

- **International Renewable Energy Agency**
 - IRENA Innovation and Technology Center (IITC)
 - Work led by the [Power Sector Transformation Team](#) under the guidance of Emanuele Taibi

- **Contact information**
 - Support on the tool: Flextool@irena.org



www.irena.org



www.twitter.com/irena



www.facebook.com/irena.org



www.instagram.com/irenaimages



www.flickr.com/photos/irenaimages



www.youtube.com/user/irenaorg